

POPULAR COMMUNICATIONS

Hear Counterterrorism, Wartime Radio Signals

Also in this issue:

- **DXing Shortwave's 60-Meter Band**
- **Decode Digital ACARS Signals From Planes**
- **Checked Out: MFJ-8100 World Band Receiver**
- **FCC Seeks Help Against Illegal CBers**

U.S. \$2.95 Canada \$3.95



*****43-DIGIT 454
 02 03753364 9603 9603Y AOR
 MR. JAMES GRAY
 2031 WIPLENG DRIVE
 DAYTON OH 45406-3823

**Satellites,
More!**

OUT OF THIS WORLD
THE NEW STAR



ASTONISHING
PERFORMANCE
AR2700
WIDEBAND SCANNER



The new AR 2700 from AOR is another break-through for general coverage scanners at an affordable price. It combines wide frequency coverage with many advanced features and options, including computer interface and voice recorder. With this small marvel, you will never miss important calls and conversations through the use of the optional digital voice recorder.

FEATURES:

Wide frequency range: 500kHz to 1,300MHz with various step size, 5, 6.25, 9, 10, 12.5, 20, 25, 30, 50, & 100kHz (wide FM only).

Auto Mode tuning: Comprehensive band plan has been pre-programmed to simplify the operation. The AR 2700 will automatically select the appropriate mode & channel step.

Great flexibility in programming, for Scan and Search mode: Delay, Pause and Priority intervals can be set to a specific value. Program search, Manual search, Bank link, Delay, Pause, Pass, Scan, Bank delete, Priority are provided.

High Capacity: 500 channels into 1- banks and 1- search banks. Large Multi-Purpose backlit LCD, including Battery indicator and sleep timer (automatic power off).

Illuminated keypad and beep: The keypad is illuminated with user selectable light On/Off, The keypad also features a beep On/Off or selected musical notes.

Optional Digital Voice Recording: 20 seconds of digitized recorded conversation and playback through the use of the RU-2700 option. Computer control port may be connected via an optional adaptor to a computer for remote control of the AR 2700.

Actual size:
2 1/2 x 1 1/2 x 6 5/8
Weight: 9.7lbs, w/batteries

AOR, LTD.
2-6-4 Misuji, Taito-Ku,
Tokyo 111 Japan (c) 1995
AOR, LTD. Licensed
under US. Pat. 4,271,111



FOR DETAILS, CALL YOUR
FAVORITE DEALER OR
CONTACT:

Electronic Distributors Inc.
325 Mill St. Vienna, Va. 22180
703-938-8105 • FAX 703-938-4525

EXCLUSIVE DISTRIBUTOR THROUGHOUT
THE U.S., CANADA, AND SOUTH AMERICA.

CIRCLE 113 ON READER SERVICE CARD

Spring Inventory House Cleaning

Drop Low Prices! We'll Match Any Legitimate Deal!

AOR

AR8000 .1-1900MHz¹ \$599.95
 AR3000A .1-2036MHz¹ \$1029
 AR5000 10kHz-2600MHz¹ SCALL
 SDU5000 Spectrum Display \$995.95
 AR3030 30kHz-30MHz Special \$599.95

OPTOELECTRONICS

CUB .1-2800MHz counter \$139.95
 M-1 10Hz-2400MHz counter \$229.95
 3000A+ 10Hz-3000MHz counter \$319.95
 Scout40 Counter Logger \$399

Discounts on entire line...CALL!
 Scout40, AOR2700/8000 package available...\$759/\$1039

BEARCAT-UNIDEN

BCT-7 Pretuned scan by state² \$169.95
 BC220XLT Portable V/UHF-800² \$224.95
 BC890XLT Base/Mob. V/UHF-800² \$229.95
 BC3000XLT Portable 25-1300MHz² \$369.95
 BC9000XLT Base/Mob 25-1300MHz² \$389.95

DRAKE

SW8 Portable \$679.95
 R8A New Desktop \$1069
 R8 Trade ins wanted, upgrade now!

GRUNDIG

YB305 New digital. Special \$124
 YB400 All Mode. SWL. Special \$179.95

ICOM

R1-15 Blocked 800-900MHz¹ No Blk Call \$429.95
 R100-11 Blocked 800-900MHz¹ \$679.95
 R7000 FCC qualified users only CALL \$1839
 R7100A-12 blocked 800-900MHz¹ \$1515
 R9000 FCC qualified users only CALL \$6250

LOWE

HF150 Compact 30kHz-30MHz \$547
 HF225E Table-top Europa HF \$1099
 HF250 New Tabletop HF \$1199
 HF250RS Remote/Synchro Det. \$1349

REALISTIC/RADIO SHACK

DX394 NEW HF. 15-30MHz. All mode \$366
 PRO26 NEW 200ch. WX. 25-1300MHz² \$349.95
 PRO46 100ch. V/UHF 800. Cell restorable \$199.95
 PRO62 NEW. 50ch. V/UHF 800² \$269.95
 PRO60 NEW. 200ch. V/UHF 800 UHF AIR² \$299.95
 PRO2037 200ch.. V/UHF 800. triple conv.² \$294.95
 PRO2039 NEW. 200ch. V/UHF 800 doub. conv.² \$229.95
 PRO2042 NEW. 100ch. 25-570/760-1300MHz² \$429.95

SANGEAN

ATS202 Mini digital 13SW. AM FM \$89.95
 ATS606P w/ Rec ANT AC adapt. 45 memo. \$169.95
 ATS303 NEW. Digital 20 memories \$89.95
 ATS818 NEW low Price. 1 - 30MHz \$130

SONY

ICFSW55 125 memo. AM/FM/SW SSB \$349.95
 ICFSW77 162 memo. .1-30MHz Synchro \$459.95
 ICFSW100S 50 memo.. mini shirt pocket system \$344.95
 ICFSW1000T NEW. all band synchro cassette \$533
 ICFSW7600G Our Biggest Seller, all band/SSB \$179.95
 ICF2010 Proven winner w/ air band \$344.95

1 - Factory Cell Blocked. EEB can un-Block your scanner - \$44
 No Block available to FCC qualified users.
 2 - Cellular Blocked Not Restorable

BEARCAT BCT-7

BearTracker with alert, pre-programmed, select your state, hear the action!!!
 National ads at \$199.95



SALE \$167

COBRA HH-70

All Controls in Mic. Secure Install. No unit visible. 40ch.. 4Watts Out. The Hottest Selling CB on the Market!
 LIST \$169.95



SALE \$97

Global Positioning System

GPS is sweeping the industry, know your location/altitude, anywhere in the world to a few feet. Trimble, Magellan, Garmin & Eagle.



SALE \$199

GE SUPERADIO III

Puts the fan back in AM/FM DX'ing. Larger ferrite rod antenna. 4 I.F. stages. Every one needs this great sounding



SALE \$59

PRO2042

100CH. 25-570/760-1300MHz (dual cell). Top End Scanner. Save \$100



SALE \$399

Trade-ins B-Stock BIG SAVINGS

on our BBS Update list SASE

Radio Shack SWL DX394

.15 - 30MHz. AM. CW. SSB. 160 memories. Mate w/ most scanners for full coverage. List \$399.95



while they last... **\$366**

SONY ICF5W1000T

Hi-Quality, all mode SWL AM/FM. cassette, Auto Reverse. Clock Timer. Tape Turn On. FREE KN-2 Headset



SALE \$533

SANGEAN ATS818

.1 - 30MHz. 88-108MHz. AM. CW. SSB. FM. SAVE over \$100. FRFE KN2 Headset incl. LIST \$239.95



SALE \$130

AOR AR8000

Scan .1 - 1900MHz. All mode with SSB. 1000 memory. 10x100ch.. RS232. Optional Software LIST \$799



SALE \$588

Drake R8A Time to Upgrade

4 Star (IBS). over 12 improvements. over R8.



Now Just \$1069

ICOM R100 NO BLOCKS

DEMO! .5-1800MHz. 120 memory channels, 13.8VDC. opt 120VAC adaptor \$19.95. was \$799. 1 year warranty.

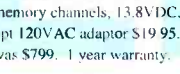

1 ONLY \$675

NEW IC706

Fantastic performance!
 Rec .1 - 200MHz. Nmit all Ham band. 160 - 6Mt. 100W. 2MT. 10W all mode List \$1560



SALE \$1228

AOR AR2700

Scanner. .1-1300MHz. AM. FM. FMW. 500 memories. RS232. Opt. Digital 20 sec. Record. Scout compatible. NEW low Price! Reg. \$399.95



SALE \$347

JEEP 1 Radio

Fashioned after the original Jeep dash. Rugged and water resistant. AM/FM/Cass/CD. end fire speakers. "O" ring watertight construction. Stores 30CD's. 8 "D" (not incl.). 120VAC AC adaptor incl.

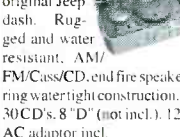

SALE \$166

OPTO SCOUT 40

Counter. Digital capture of signal. Reaction Tune AOR Scanner 8000/2700. RS232 output. LIST \$449



SALE \$399

SONY ICF/600G

Our Biggest Seller! All SWL. Synchronous detection. SSB. Key input. 22memory channels. Opt AC not included!



NOW \$179

75% OFF SONY CRF-21V

list \$399.5 **NOW \$99.5**
 LIMITED QTY
 9kHz-30MHz FW. VHF. SAT. Fax Printer. All Mode. See our other Ad.

LOWE HF150

Rugged HF. Full coverage. excellent audio. Dynamics. Synchro AM. much more. Our Jan PC ad price \$649.95



SALE \$547

GRUNDIG YB305

.1 - 30MHz. 88 - 108MHz. 30Mem. AM. FM. FREE KN2 Headset LIST \$179.95



SALE \$124

NV100-1

Night Vision - Now the public can afford to see at night. A must for security, hunting, camping stargazing. NV-100 100mm. f1.4 lens w/ IR. Lowest Price in U.S.



SALE \$347

SYSTEM PACKAGE DEAL

Includes: Scout 40. Scanner. Scanner Mods. Interconnect Cable. 1 year extended warranty. AR8000, Scout 40 \$1019 AR2700, Scout 40 \$759 Send your AR8000 & Scout 40 in and we'll do the mods. incl. cable, 1 YR. warranty on our work, check-out system with your new Scout and return UPS. \$429

SALE \$429

Drake R8 Used

We have several clean used R8's at Big SAVINGS! 100% OK thru EEB lab. 90 Warranty.



Under \$700

WRTVH 1995 PASSPORT 1995 50% OFF

WRTVH95 \$12.45
 PASSPORT95 \$9.95
 LIMITED QTY

The most sophisticated, accurate and easy-to-use weather stations are now even better. For years, thousands of people have turned to Davis for weather monitoring equipment for their homes and offices, schools, fire stations, factories, and farms. Now Davis introduces a new line with redesigned displays and keyboards, new features (including humidity, dew point, and barometric trend), and state-of-the-art microprocessors for the utmost in accuracy.

All Davis models offer the most advanced weather monitoring technology available. Whatever your weather monitoring needs, one of Davis models is sure to offer a practical and versatile solution.

Add computer software, expand your system with plots-graphs and more!

Free 12pg Color Catalog \$Call/Fax. EEB Will Beat Any Advertised Deal-Call



	7400	7415	7425	7440		
Temp inside	*	*	*	*	7400 Perception	\$134.95
outside	*	*	*	*	7415 Wizard IIs	\$134.95
Hum inside	*	*	*	*	7425 Wizard III	\$169.95
outside	*	*	*	Opt	7440 Monitor II	\$349.95
Barometric	*	*	*	*	7852 Rain Collector	\$69.95
Rain Fall	*	Opt	Opt	Opt	7859 ExtTemp/HVM	\$89.95
Time/Date	*	*	*	*	7862/7866 IBM/MAC	\$149.95
Wind Speed	*	*	*	*	7520 Stand Alone Rain Gauge	\$89.95
Direction	*	*	*	*	7815 Remote Display All units	\$89.95
IBM/MAC	Opt	Opt	Opt	Opt		

EEB
 323 Mill St.
 Vienna, VA.
 22180

Orders: 800 368 3270
 INFO/Metro: 703 938 3350
 BBS: 703 938 3781
 Internet: eeb@access.digex.net

• Prices subject to change
 • Prices do not include freight
 • Returns subject to 20% restock fee
 • FREE 1996 Catalog, 3rd Class, U.S.

EEB

POPULAR COMMUNICATIONS

MARCH 1996

VOLUME 14, NUMBER 6



page 8

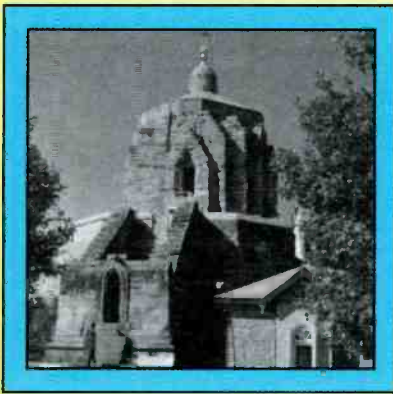

page 18

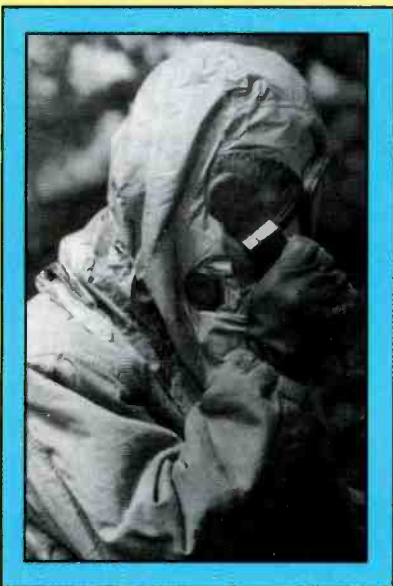

page 12

FEATURES

- Wartime Radio** 8
 Journalists see the reality of Salvadoran stations.
By Jeremy Bigwood
- Monitor the Terrorist Threat!** 12
 HF/VHF/UHF lets you hear the action from a safe distance.
By Tom Kneitel, K2AES, Senior Editor
- DXing 60 Meters** 18
 Take the shortwave 5 MHz challenge.
By Gerry L. Dexter
- Tuning In On Yesterday** 24
 Sneak a peek a some more forgotten firsts.
By Alice Brannigan
- Books You'll Like** 32
 Technical Writing, Applied Cryptography and Tuning In On Telephone Calls.
By R.L. Slattery
- Checked Out** ✓ 34
 POP'COMM reviews products of interest.
By W.W. Smith

COLUMNS

How I Got Started	31
Antennas 'n' Things	36
Telephones Enroute	38
Clandestine Communique	41
You Should Know	42
Satellite View	46
Broadcast DXing	49
Communications Confidential	54
The Ham Column	59
Listening Post	60
Pirates Den	67
Product Parade	68
CB Scene	70
Washington Pulse	74
Emergency	78
Scanning VHF/UHF	80

DEPARTMENTS

Thoughtwaves	5
Mailbag	6
World Band Tuning Tips	44
Communications Shop	84

This month's cover: A U.S. Army Special Forces A-Team during a jungle training operation utilizes ANPRC-77 secure communications equipment to report back recon intelligence. Photographed with cooperation of Counter Group Police Academy, Poughkeepsie, N.Y. Photograph by Larry Muluehl, WB2ZPI

QUALITY COMMUNICATIONS EQUIPMENT SINCE 1942

AMATEUR RADIO EQUIPMENT

KENWOOD

YAESU

ICOM

JRC

SR STANDARD

AEA

ALINCO



Universal has been selling the finest in new and used amateur radio equipment since 1942 and is an authorized sales and service center for all major lines.

COMMUNICATIONS RECEIVERS

YAESU

KENWOOD

JRC

DRAKE

LOWE

ICOM



Universal Radio carries an excellent selection of new and used communications receivers. JRC NRD-535D shown.

RTTY AND FAX DECODERS

◆ Universal M-8000 Decoder



The professional-grade M-8000 was designed primarily for the military, commercial and diplomatic user, but can be used by the hobbyist who requires maximum intercept capability. The color VGA output includes a spectral display and simulated tuning scope. Modes currently include: CW, Baudot, FAX, SITOR, ARQ-M2 & M4, ARQ-E/E3, ARQ6-90, ARQ-S, SWED-ARQ, FEC-A, FEC-S, ASCII, Packet, Pactor, Piccolo, VFT, ACARS, POCSAG and GOLAY. Too many features to list here. Monitor and printer optional. **\$1349.00 (+\$10)**

◆ Universal M-400 Reader



The self-contained Universal M-400 is a sophisticated decoder and tone reader offering exceptional capabilities. The SWL can decode: Baudot, SITOR A and B, FEC-A, ASCII and SWED-ARQ. Weather FAX can also be decoded to the printer port. The VHF-UHF listener can copy the ACARS VHF aviation teletype

mode plus GOLAY, POCSAG and SUPER POCSAG digital pager modes. Even off-the-air decoding of DTMF, CTCSS and DCS. Big two-line, 20 character LCD and parallel printer port. The M-400 runs on 12 VDC or with the supplied AC adapter. No computer or monitor is required. Made in the U.S.A. **\$399.95 (+\$6)**

◆ Universal M-1200 Decoder Card

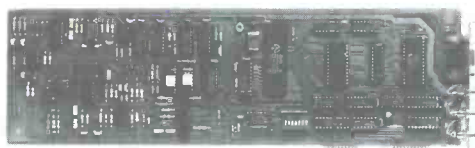

Turn your PC into a powerful intercept device! Reception modes include: CW, Baudot RTTY, SITOR, FEC-A, ARQ-M2, ARQ-E/E3, FAX and ARQ6-90 plus ASCII and Packet. VHF

enthusiasts can copy PL, DCS, the ACARS aviation mode, POCSAG and GOLAY. Operation is easy through on-screen menus, status indicators and help windows. Requires PC with VGA monitor. Made in the U.S.A. **\$399.95 (+\$5)**



HUGE FREE COMMUNICATIONS CATALOG

Universal offers an informative catalog covering everything for the shortwave, amateur and scanner enthusiasts. With prices, photos and full descriptions. It's FREE by bookrate, or for \$2 by first class mail. Request it today!

COMMERCIAL RECEIVERS



wj

The Watkins-Johnson HF-1000 is the ultimate receiver! Advanced D.S.P. technology, 58 bandwidths, 1 Hz display. Under \$4000. Please contact us to receive a spec. sheet.

PORTABLE RECEIVERS

ICOM

SONY

GRUNDIG

SANGEAN



Universal offers over 40 portable receivers from \$20 to over \$500. Our free catalog fully describes & prices all models.

COMMUNICATIONS BOOKS

● Passport To Worldband Radio By L. Magne

Graphic presentation of all shortwave broadcast stations. Equipment reviews, too. A must have book. **\$19.95 (+\$2)**

● World Radio TV Handbook

All shortwave broadcast stations organized by country with schedules, addresses, power, etc. **\$24.95 (+\$2)**

● Worldwide Aeronautical Frequency Dir. By R. Evans

The definitive guide to commercial and military, HF and VHF/UHF aero communications including ACARS. Brand new huge Second Edition. 260 pages. **\$19.95 (+\$2)**

● Shortwave Receivers Past & Present By F. Osterman

Your guide to over 200 receivers with new and used values, specifications and features. Photos for most. **\$9.95 (+\$2)**

● Comprehensive Guide to Military Mon. By Douglass

Covers equipment, SW and VHF/UHF frequencies, identifiers, playbook, bases and black projects. **\$19.95 (+\$2)**

● Discover DXing! By J. Zondlo

An introduction to DXing AM, FM and TV. **\$4.95 (+\$2)**

● The World Below 500 KiloHertz By P. Carron

An introduction to the world of longwave DX. **\$4.95 (+\$2)**

● Understanding ACARS By E. Flynn

Learn how to decode the ACARS format. **\$9.95 (+\$2)**

Be sure to include \$2 per title for shipping.

SPECIALS

■ Kchibo KK-210B 21 Band LW/MW/SW/FM Receiver

This amazing analog portable covers LW, MW, FM and all shortwave frequencies from 2.3 to 26 MHz! **\$19.95 (+\$4)**

■ Sony ICF-M350V AM/FM/TV-audio/Weather Receiver

This fully digital portable receiver lets you hear AM, FM, VHF TV audio or weather anywhere. A great gift. **\$49.95 (+\$5)**

- Visa
- Prices and specs. are subject to change.
- MasterCard
- Returns subject to a 15% restocking fee.
- Discover
- Used equipment list available.

Universal Radio, Inc.
6830 Americana Pkwy.
Reynoldsburg, Ohio
43068-4113 U.S.A.

☎ 800 431-3939 Orders & Prices
☎ 614 866-4267 Information
➔ 614 866-2339 FAX Line

universal
radio inc.



Are You Listening?

CATCH **THE** Action

WITH **an** INTERCEPTOR!

R10 INTERCEPTOR

If searching out RF signals is your thing, then the R10 Interceptor is the answer. The R10 searches out nearfield signals and locks on in 8ms. It provides a shield of protection that no RF signal can penetrate without being detected. Unlike scanners and receivers that must be tuned to a specific frequency or scanned through a fixed frequency range, the INTERCEPTOR will provide an exciting new dimension in recreational monitoring with near instant response to strong signals. Communications monitoring hobbyists will be able to take the R10 on cruise ships, to military bases, theme parks, zoos, airports, to space shuttle launches, parades, sporting events, car races and anywhere two way FM communications is used. •Check Deviation with 10K or 100K range •Check Relative signal strength •Continuous 30MHz-2GHz coverage in less than 1 second •Built in Speaker •Thumb wheel volume and squelch control •Supplied with telescoping whip antenna, Internal NiCad battery pack, and an AC charger

R20 INTERCEPTOR

The R20 is a compact RF signal strength detector with a 10 segment bargraph display. There is also an audio output from the detector for monitoring AM communications. The audio output is useful for room sweeps where in close proximity to a transmitter a quieting effect can be heard due to detector saturation. •The 10 segment LED bargraph responds to all RF signals with nominal 3dB increments •Pocket sized with built in telescoping whip antenna •9 volt battery operation •Monitor Aircraft, CB, AM Broadcast transmissions •Check Microwave oven leakage •Wide .5MHz-2.5GHz range

**NEW
DISCOUNTED
PRICE!**



R20 \$119.00

R10 \$299.00

OPTOELECTRONICS

5821 N.E. 14th Avenue • Ft. Lauderdale, Fl. 33334

Contact Factory for shipping prices. Visa, MasterCard, & C.O.D. (Cash or Money Order Only)

All prices and specifications are subject to change without notice or obligation

MADE IN THE U.S.A.

ORDER LINE: 800-327-5912 TEL. 305-771-2050 FAX 305-771-2052

CIRCLE 125 ON READER SERVICE CARD

www.americanradiohistory.com

POPULAR COMMUNICATIONS

EDITORIAL STAFF

Chuck Gysi, N2DUP, Editor

(Internet e-mail: POPCOMM@aol.com)

Tom Kneitel, K2AES/KNY2AB, Senior Editor

Deena Marie Amato, Associate Editor

Richard S. Moseson, NW2L, Online Coordinator

CONTRIBUTING EDITORS

Gerry L. Dexter, Shortwave Broadcast

Gordon West, WB6NOA, Emergency

Don Schimmel, Utility Communications

Edward Teach, Alternative Radio

Tim Kridel, AM/FM Broadcasts

Capt. William Mauldin, WG4R, Thoughts & Ideas

Donald E. Dickerson, N9CUE, Satellites

Brian Battles, WS10, Amateur Radio

Joe Carr, K4IPV, Antennas

Ted Lisle, KD4EXK, Handi-Chat

Jock Elliott, SSB-734, Citizens Band

J.T. Ward, Scanning

W.W. Smith, Product Reviews

BUSINESS STAFF

Richard A. Ross, K2MGA, Publisher

Donald R. Allen, N9ALK, Advertising Mgr.

Emily Kreutz, Sales Assistant

John Dorr, K1AR General Manager

Frank V. Fuzia, Controller

Simon Schatzmann, Circulation Director

Catherine Ross, Circulation Manager

Melissa Nitschke, Operations Manager

Carol Licata, Data Processing

Denise Pyne, Customer Service

PRODUCTION STAFF

Elizabeth Ryan, Art Director

Barbara Terzo, Associate Art Director

Susan Oliveri, Assistant Art Director

Edmond Pesonen, Electronic Comp. Mgr.

Dorothy Kehrwieler, Production Manager

Emily Kreutz, Assistant Production Manager

Wendy Motchan, Promotions Manager

Pat Le Blanc, Phototypographer

Hal Keith, Technical Illustrator

Larry Mulvehill, WB2ZPI, Photographer

A publication of



CQ Communications, Inc.
76 North Broadway
Hicksville, NY 11801-2953 USA

Offices: 76 North Broadway, Hicksville, NY 11801. Telephone (516) 681-2922. FAX (516) 681-2926. Popular Communications (ISSN-073-3315) is published monthly by CQ Communications, Inc. Second class postage paid at Hicksville, NY and additional offices. Subscription prices (payable in U.S. dollars): Domestic—one year \$22.95, two years \$41.00, three years \$60.00. Canada/Mexico—one year \$32.95, two years \$61.00, three years \$96.00. Foreign—one year \$34.95, two years \$65.00, three years \$96.00. Foreign Air Mail—one year \$82.95, two years \$262.00, three years \$240.00.

U.S. Government Agencies: Subscriptions to Popular Communications are available to agencies of the United States government, including military services, only on a cash with order basis. Requests for quotations, bids, contracts, etc. will be refused and will not be returned or processed.

Entire contents copyright © 1996 by CQ Communications, Inc. Popular Communications assumes no responsibility for unsolicited manuscripts, photographs, or drawings. Allow six weeks for change of address or delivery of first issue.

Printed in the United States of America.

Postmaster: Please send change of address to Popular Communications, 76 North Broadway, Hicksville, NY 11801.

BY CHUCK GYSI, N2DUP

Thoughtwaves

AN EDITORIAL

Say It Ain't So!

As I prepared this month's editorial, some very disturbing news was filtering over the news wires and the Internet. By the time you read this, you probably will have heard whether it actually transpired.

You see, the coffers that kept Radio Canada International on the air dried up. The Canadian Broadcasting Corp. announced late last year that it no longer could afford to spend \$12.2 million (U.S. dollars) to keep the external voice of Canada on the air. That meant the shortwave station had to pack its bags and put 125 employees out of work. All of this is to happen March 31, 51 years after the station first went on the air.

Radio Canada International is woven into the listening of almost every North American SWL. We've all listened to the station and it very well may have been your first "foreign" SW catch. I know I loved listening to RCI as a kid in junior high school just getting my feet wet in SWling. I always was fascinated by the neighbor to the north and delighted in tuning in RCI's programs when I got my first SW receiver.

As many around the world did, I became a member of the Radio Canada Shortwave Club. I still have the certificate hanging in my shack and I always have remembered my member number (12852)! RCI went far for the SWLs with the information and assistance it provided to hobbyists. I bet most of those wrote from the United States, too.

When I attended a few ANARC conventions in the 1970s, one of the treats that went with attendance was being in the company of Ian MacFarland, then the host of Radio Canada's ever-popular DX program. Ian is a SW celebrity in his own right, and his appearance and remote broadcasts at events such as those brought home shortwave radio, as global as it is.

However, unless those who fund RCI find new sources of money, the beloved station will be off the air come March 31. It would be sad not only for RCI, but also because RCI's Sackville, New Brunswick, transmitter site relays programming to North America from England, Germany, Austria, Portugal, Korea, Japan and China. POP'COMM took our readers on a tour of the nine-transmitter facility in the January issue.

Many Canadians—both home and abroad—as well as SWLs are rallying to keep Radio Canada on the air from its studios in Montreal, Quebec. But unless the Canadian government sees the error of its ways in keeping its largest ambassador on the air, RCI will fade off into the sunspot cycle come the end of the month.

RCI currently broadcasts at least 232 hours a week in eight languages (English, French, Ukrainian, Russian, Arabic, Spanish, Chinese and Creole) to North America, South America, the Caribbean, Africa, Europe, Asia, Russia and the other successor states to the USSR. RCI also provides 24-hour daily satellite radio service for Canadian Forces in Bosnia, the Golan Heights, Rwanda and Haiti, and NATO bases in Germany, Belgium and the Netherlands.

Radio Canada has an estimated shortwave audience of more than five million, plus an estimated 10 million or more listening to RCI programs on local stations or via satellite.

I personally hope that Canadian government can find the funding to keep RCI on the air in some form. It will be sadly missed if it leaves the air.

New Column

This month, we welcome W.W. Smith as a contributing editor to the pages of POP'COMM. W.W. is a long-time, well-rounded radio hobbyist who knows equipment. On that note, I asked W.W. to start a new product review column for us.

This month, you will see a column entitled Checked Out, where you will be able to read our expanded product reviews. If you have a product you'd like to see W.W. check out in this column, write to him in care of the magazine!

Web Page

No sooner did we advertise our new homepage on the Internet's World Wide Web in January, that the page crashed and left us without anything on the web. A quick temporary web page was added back to the site (<http://home.aol.com/popcomm>) and we are working to get the new site up soon. A link will be added from the old site.

73, Chuck

GMRS

EMERGENCY

Radios

- Hiking
- Fishing
- Skiing
- Camping
- Traveling
- Hunting
- Personal communications

MAXON

GMRS-210+3
2-5 Watt portable
Only \$ 190.00

SM-2450
25 Watt 4 Ch mobile
Only \$ 299.00

SM-4450
40 Watt 16 Ch mobile
Only \$ 375.00

GMRS RADIO SALES

P. O. Box 37825
Phoenix, AZ 85069
1-800-571-GMRS
Fax: (602) 878-6398

CIRCLE 61 ON READER SERVICE CARD



SIGNAL ENGINEERING'S

High Performance CB &
10 Meter Antennas

SUPERHAWK

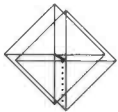

Goldenrod
45 Spyder A+
Broadband Hi
powered MOBILE

WHITE LIGHTNING

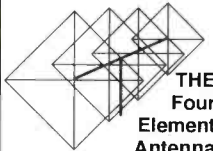

THUNDER 8
Bi-Directional
Hi Gain OMNI
Electronically
Steerable

THE
Four
Element
Antenna

LIGHTNING 6

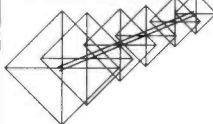

**And, also,
NEW QUAD
LIGHTNING 8**
THE most
POWERFUL
CB base in the
world today!

ALL SE PATENTED rotary beams are true quads and OUTPERFORM their counterparts (quad/yagi types). SE's patented SFS matching system makes SE QUADS the most technologically advanced antennas in the world today.

If your dealer doesn't have SIGNAL ENGINEERING, write or call for full specs. DEALER inquiries invited. MasterCard, VISA, AMEX, Discover

SIGNAL ENGINEERING

155 San Lazaro Ave, Sunnyvale, CA 94086
(408) 733-1580

Mailbag

LETTERS TO THE EDITOR

Each month we select representative reader letters for our Mailbag column. We reserve the right to condense lengthy letters for space reasons and to edit to conform to style. All letters submitted must be signed and show a return mailing address or valid e-mail address. Upon request, we will withhold a sender's name if the letter is used in Mailbag. Address letters to: Chuck Gysi, N2DUP, Editor, *Popular Communications*, 76 N. Broadway, Hicksville, NY 11801-2909, or send e-mail via the Internet to POPCOMM@aol.com.

Back In the Old Days

Reading your first Thoughtwaves column reminded me of my early days DXing in Philadelphia. I was 8 years old in 1967 when I got a nine-transistor radio. At that time, my friend and I thought that the more transistors you had in the radio the better it was. I had a "nine" and he had an "eight." DXing back in those days was fun. You could get KFI in Los Angeles beginning around 8 p.m. in the wintertime and they stayed in all night! Later on I would listen to Herb Jepko on KSL with the *Nightcap Show*. You can't get KFI anymore because of WWJZ in Mount Holly, N.J., on 640 and KSL, well forget that, too.

Philly had some great air personalities back then on WFIL, WIBG and WIP. Remember George Michael, Joe Niagara, Hy Litt, Ken Garland, Joe McCauley, Wee Willie Webber, Dick Clayton, and on and on and on? I still have a tape of Joe McCauley saying happy birthday to me on my ninth birthday.

A little about me: I am 36 years old, married with three children, and a licensed ham (N4TKR), I work for AT&T, and I am totally blind and have been all my life. I read POP'COMM in Braille and look forward to it every month. Good luck in your role as editor. I'm sure you will do a great job!

Roy McCutcheon
(via the Internet)

It never ceases to amaze me that several of the broadcasters of that era still are on the air in the Philly market! There's always a station with a format that can use them. Don't forget that Wee Willie Webber was one of the few that also was in television, with his afternoon kiddie show on WPHL, Channel 17, for several years. Also, if you recall the Cruisin' series of rock 'n' roll radio al-

bums that were produced in the 1980s... if you can find the Cruisin' 1957 album, you'll hear Joe Niagara of WIBG with songs of the era, plus commercials for local establishments.—Editor.

Reaching For the Switch

I have been a subscriber to POP'COMM for the last eight years or so and find that it is one of the best—if not the best—magazines in conjunction with the scanner and SWL hobbies.

However, in all that time I have not seen one of the oldest CB sets that I can recall. It was my first one: It was made by Philmore, was super-regenerative, had three transmit frequencies inside with a socket for additional crystals on the outside. The push-to-talk button was on the front of the set instead of the mic. It was no mean feat driving down the street and talking at the same time.

What was even more fun was that when you keyed up, it clobbered two channels in either direction! Needless to say, it was replaced by the superheterodyne that worked much better. I owned it back in the early 1960s. I graduated to better, including a build-it yourself Heathkit, and one of the first solid-state models, the Cadre 505. When I saw the article about it in the magazine, it sure brought back fond memories.

I finally got a ham ticket and now I can play with the big kids. Keep up the good work with your magazine, and don't forget the little guy who may just have a short-wave radio that he uses to listen to the BBC, the Voice of the Andes or just a ham on the other end of the country. This person has the potential to become a good ham; all we have to do is cultivate them. I know; that what's happened to me.

Ed Cifelli, KC7MWP
Tempe, Ariz.
(via America Online)

Ed, those first CB rigs were a lot like the ham rigs of the time with the key-to-talk switches on the front of the radio instead of on the mic. It probably wasn't until the 1970s when CB radios really became more unique and didn't look like the clunky HF rigs that hams used. I remember the box of transmit crystals I had for my first rig, a Lafayette Comstat 19. I didn't spend my hard-earned paper route money on receive crystals because the rig had a tunable receiver and I just kept spinning the dial until I heard my friends!—Editor

The Latest Software Available At Your Favorite Dealer!

Remote Computer Scanning System

The RCSS, Windows '95 compatible Software significantly enhances the AOR AR8000 receiver's capabilities by providing automate Personal Computer control over the receiver's scanning, logging and memory functions! These features and many more make this software a great choice for Windows use:

- Auto detection and storage of active frequencies and add'l. info while scanning
- Scan user specified tuning steps from 10Hz - 100 MHz
- Scan by mode, class of service, or type of unit
- True signal detection allows scanning upon loss of carrier with user supplied delay
- Max scan rate, user adjustable
- Scan by radio or computer
- Unattended frequency monitoring by time and date
- Lockout unwanted signals
- Rearrange all freq. in any combination by click/drag or entry



SCANCAT GOLD

SCANCAT

presently supports:

- AOR 3000/3000(A) & AOR2500, AR3030 HF receiver, AR8000 (Newest handheld)
- Drake R-8
- MOST Icom Radios
- Kenwoods including TS-440, TS-450, TS850 & R5000
- MOST Yaesu's including FRG-8800 & FRG-9600 Yaesu, PLUS FRG-100, FT-840 and more!
- The NRD-525 & 535 JRC.
- LOWE HF-150m
- Watkins Johnson HF-1000
- Opto Electronics add-on boards for PRO series Radio Shack Radios.

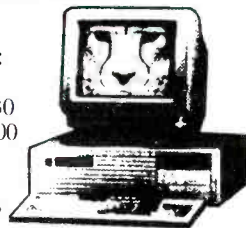

Our software allows complete control of all functions supported by these radios through the standard manufacturer's interface.

SCANCAT allows you to:

1. Enter any one frequency and increment up-down from that point.
2. Enter any two frequencies and scan between them with ANY increment, time delay or pause.
3. Scan a file of frequencies, search by description or wildcards.
4. Create Databases of frequency files. Sort by any field, and save to disk -and/or send to printer.
5. Create 30 personal "Preset" frequency BANDS for SW, aircraft etc. including increment and mode. The most popular presets are included in the program.

- Multiple Scanning Banks
- Multiple Scanning Diskfile Banks
 - Unlimited Files Sizes
- Dual Radio Simultaneous Scanning
- Comma Delimited Conversion
- D-Base Support, Scanport- Gold
 - Direct Import of TRS
 - Macro Control per Record
 - Command Line Control
 - Automatic Birdie Lockout
 - Top Hits Table

WINDOWS™ Control for Scanners

ScannerWEAR™ SoftControl 2.0-WINDOWS 95'

compatible now supports:

- OptoScan 456 with Radio Shack PRO 2005/2006
- AOR 3000/3000A/8000 with Radio Shack PRO 2035
- ICOM R7000/R7100/R9000
- Memory banks include 100 channels per bank with frequency, description and mode.
- Search ranges include frequency, step, mode and description. New database search by service codes.
- Data logging to the file includes date and time stamp, signal strength, tone and number of hits, location (requires PerCon Database)
- Spectra analysis uses search ranges or displays logged data
- NEW High Speed CTCSS & DCS controlled scanning with the RS-2005/6, RS-2035 and OptoScan with 456/535
- CTCSS & DCS controlled scanning on R7000/7100 & AOR 3000/3000A AOR 8000 with optional RC-125 Tone Interface Box
- Scan multiple groups, banks, or search ranges in the same session.
- Birdie control file. * Unlimited file size.
- Import PerCon Database and comma-delimited ASCII.
- Special Eprom support for the AOR 8000 including up and downloading of hex values, plus MODPLAN to enable lost 800-900 mhz.
- NEW database scan by service code, create memory banks from service codes.
- NEW memory bank up and downloads for ICOM R7000/R7100/R9000 and AOR 3000A/8000.
- NEW config window with support for com ports 1-8, IRQ calls on all ports, user modifiable dwell setting for all radios.
- NEW slave- master scanning with CIV protocol, scan on your receiver and all hits are transferred to the slave receiver for monitoring.
- NEW minimize window allows viewing of freq status while
 - in any other WINDOWS or DOS application.



Computer Interface for the AR8000 & AR2700

Unlike some of the European devices sold today, this unit is smaller, lighter, and makes no power demands on your receiver. With the extra shielding and smaller size there is less chance of additional interference leaking into your radio. The AR8000INF is also the only interface that is upgradeable for use with the optional Tape recorder controller due first quarter '95.



- △ Low Power, powered by your serial port
- △ No Drain on the batteries in the radio
- △ Light weight, perfect for Laptop use
- △ Hi-Tech Surface mount design for reliability
- △ 100% Shielded cable to receiver for reduced interference
- △ PC Software included for Windows and DOS
- △ Detailed Programers documentation available
- △ Designed and Manufactured in the USA

Electronic Distributors

325 Mill Street Vienna, VA 22180

Ph: (703) 938 8105 FAX: (703) 938 4525

Exclusive North and South American Distributors



Wartime Radio

Salvadoran Stations Play Out Real Life for Journalists

BY JEREMY BIGWOOD

"Hello, Commander Two-Zero."

"Go ahead, over."

"Listen in—(it's) hitting the fan pretty bad out here. ... I'm ... I'm bailing out of here. ... Got to get out of here. (It's) hitting the fan, over? ... I'm telling you, I do not want anybody to call on me tonight. ... Just come out for me tomorrow, over."

"Commander Two-Zero, this is Retelo. Go ahead, over."

Muffled explosions and unscrambled voices emanated from my scanner, a RadioShack Pro-2004. Looking over at it from my bed through sleepy eyes, I could see its familiar green light showing scanned frequencies. Above it, laying over the speaker, was a Sony PearlCorder, set to "vox," still in its leather sheath. The backlit face of a travel-alarm clock glowed 0400 Salvadoran time. The scanner was playing out an attack on a Salvadoran army base by leftist FMLN guerrillas—blow by blow. "Commander Two-Zero" had to be the code name for a U.S. military adviser, and "Retelo" the on-duty U.S. officer at the U.S. military group's headquarters in San Salvador.

It was February 1989, and I was work-

ing as a photojournalist covering the wars in Central America for a New York photo agency. I had bought the scanner on a recent trip to the United States and smuggled it into El Salvador, where scanners were considered illegal and subject to confiscation by the military government.

During a rushed visit by then-Vice President Dan Quayle, I had started to search the airwaves for police, Army and embassy frequencies, and also those of the FMLN guerrillas. After hours and sometimes days of monitoring frequencies, the scanner locked onto various Salvadoran police frequencies at about 179 MHz, and later vectored in on U.S. Embassy traffic, and even better—the clear, unscrambled frequencies of the U.S. military advisers attached to the military bases throughout the country.

The scanner switched to other frequencies, then, suddenly Two-Zero was back:

"As you know, we are being probed... we also are receiving rampas, over. ... At this time, it's just probing fire. ... They fired a couple of RPG-7s, but that's about it, over."

He clearly was under intense fire from both small arms, rocket-propelled grenades (RPG-7s) and guerrilla-homemade rampas—explosives catapulted by smaller

charges from a wooden crate. I could imagine guerrillas, some of them almost naked, covered in black mud probing the base, illuminated by parachute flares in a tracer-slashed nightscape.

"How many people are doing the probe? Over."

"Right now, I estimate four to five. They might be the...they may be the... uh...front element of a bigger unit with rampas, but I'm not sure right now. ...They're coming in again. We are getting rampas, over."

And then static:

"Hello, this is Commander Two-Zero."

"Commander Two-Zero, Retelo. Go ahead, over."

"Yeah, the probe has turned into an ... attack from the northeast. We got, ah ... three wounded already, we have one blindado in ambush ... And we got one kid—he's in pretty bad shape. He's probably going to go away. And we have two other wounded, over."

Now it was getting more serious. The guerrillas had taken out a blindado—an armored personnel carrier. I needed to know where this action was taking place, for I still didn't know from which base Two-



Salvadoran troops in combat with FMLN guerrillas. The officer is calling in an air strike. Photo was taken in the Nonualcos in southern El Salvador in 1989. (Photo by Jeremy Bigwood)



A Salvadoran army radioman after combat with FMLN guerrillas. Note the heavy PRC-77 radio antenna and telephone. Photo taken in the Nonualcos, southern El Salvador, in 1989. (Photo by Jeremy Bigwood)

AR5000 CYBERSCAN... The Ultimate Receiver

Join the AOR Revolution with high tech, state of the art receivers

Never before has there been so much in such a small package. Hear naval submarine command and control at 21.4kHz, push a button and copy GOES WX Satellite 1691MHz.

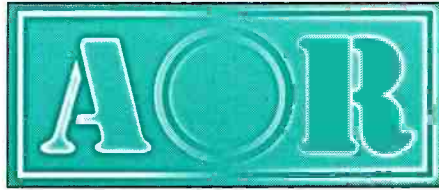

AR8000 shocks the market. AOR made every effort to incorporate the latest technology in to this new scanner.

• SPECIFICATIONS •

- **Range:** .5 - 1900MHz* usable to 100kHz
 - **Modes:** AM/NFM/WFM/USB/LSB/CW
 - **Stepsize:** 50Mz to 999.995kHz
 - **Sensitivity(μV):** 30 to 1000MHz
SSB .2 AM 1.0 NFM .35 WFM 1.0
 - **Filters:** (kHz) SSB 4 AM/NFM 12 WFM 180
 - **Memories:** 50 ch. x 20 banks= 1000 total
 - **Size/Wt.:** 6.1 x 2.8 x 1.6 inch. 20 oz. batt. incl.
- * Cell blocked for all, but Approved agencies.



10kHz-2600MHz

Leading Edge Technology has now become affordable.

The answer to every receiver need. Prior to the AR5000, it took two, three or even four receivers to cover this range, plus the small size and low power demands make the AR5000 ideal for field use, remote control radio, and local & remote computer control. Every circuit and component is state-of-the-art, surface mount technology. Low noise circuits and devices assure wide dynamic range and great sensitivity.

- Totally computer controllable.
- Local and remote control of all functions.
- 7 I.F. Band width filters
- Triple conversion to reduce imaging.
- Multi-Receiving modes covers today's data and voice communications.
- High speed scan and search modes
- 1000 memory channels (10 Banks x 100ch)
- 2 antenna inputs computer/front panel control.
- Varactor RF tuning .5 - 500MHz for low cross talk and intermod
- Switchable attenuator for high RF environments.
- Power 13.8VDC at <1amp, AC Adaptor included
- Small, lightweight (approx. 8.5"W x 3.5"H x 10"Deep)
- SDU5000 compatible

AR5000 Specifications

Frequency Range:
10kHz - 2,600MHz
Receiving Mode:
FM, AM, LSB, USB, CW, Special
I.F. Bandwidth: 3kHz, 6kHz, 15kHz, 40kHz, 110kHz, 220kHz, 0.5kHz (Opt.)
Triple Conversion: I.F.
622.2, 10.7 & .455MHz
Frequency Stability:
±1ppm (0 to 50C) ext OSC jack
Antenna Impedance:
50-Ohm (N, BNC)
Programmable Step:
1Hz to 999.999kHz
Search/Scan Speed:
50 steps/second (less than 100kHz steps)
Power Supply:
DC 12V, (<1A) 120VAC adaptor incl.

"The New Star" AR 2700...Out of this world Wideband Scanner

The new AR 2700 from AOR is another break-through for general coverage scanners at an affordable price.

• FEATURES •

- **Wide frequency range:** 500kHz to 1,300MHz with various step size. 5, 6.25, 9, 10, 12.5, 20, 25, 30, 50, & 100kHz (wide FM only).
- **Auto Mode tuning:** Comprehensive band plan has been pre-programmed to simplify the operation. The AR 2700 will automatically select the appropriate mode and channel step.
- **Great flexibility in programming:** for Scan and Search mode. Delay, Pause and Priority intervals can be set to a specific value. Program search, Manual search, Bank link, Delay, Pause, Pass, Scan, Bank delete, Priority are provided.
- **High Capacity:** 500 channels into 10 banks and 10 search banks.
- **Optional Digital Voice Recording:**



20 seconds of digitized recorded conversation and playback through the use of the RU-2700 option.
Computer control port may be connected via an optional adaptor to a computer for remote control of the AR 2700.

AR 3000A
Compact, professional quality, wide range monitor receiver



Incredibly wide continuous coverage from 100kHz all the way up to 2036MHz* • Receives all modes • FM, AM, FMW, LSB, USB, and CW - so you'll hear everything! • Superb R.F. performance thru the use of 15 switched discreet band-pass filters with GaAs FET R.F. amplifier, delivers high sensitivity, wide dynamic range and excellent intermodulation rejection • Tuning rates are continuously selectable from 50Hz to 1MHz steps • True professional's choice!



Electronic Distributors

325 Mill Street Vienna, VA. 22180

Ph: (703) 938 8105 FAX: (703) 938 4525

Exclusive North and South American Distributors



Zero spoke. But this detail probably would be broadcast during the local morning commercial news in a program from COPREFA, the army press and propaganda office. Knowing that it was recorded, I drifted off to sleep.

The next morning I missed the guerrilla shortwave station broadcasts, but listened to the commercial AM radio news programs. Although these included some fine journalists on their staffs, they were obliged to run the government's COPREFA report.

The report mentioned that several guerrillas had died attacking a military base in the southern town of Zacatecoluca. Now I knew where it had taken place. According to the hissing announcer, the cowardly attack by delinquent terrorists had been successfully repelled by the heroic soldiers of the armed forces, who had suffered no casualties in the process. Without the scanner, this official version of the events would have been the "news."

At 1800 local, I tuned my Sony to the guerrilla shortwave station, Radio Farabundo Marti, broadcasting on the low end of the 3-MHz band from the northern Salvadoran department of Chalatenango. The signal was weak, and just as I fine-tuned it during the Salvadoran national anthem, a clear sound came on, followed by a loud signal playing heavy metal rock. The government was jamming again. I could wait for Radio Farabundo Marti to move its signal from under the jamming or look for the other guerrilla shortwave station.

Pushing in the station preset button and turning the dial revealed Radio Venceremos broadcasting from the northeastern part of the country—unhindered by government jamming. A woman's voice reported a successful attack on the army engineers' base near Zacatecoluca, where several soldiers had been killed, including a major. The guerrillas had suffered wounded, but also had decommissioned an armored personnel carrier. There was no word of the brave, but shaken U.S. adviser, who must have survived. I wrote down the details of the broadcast and added a transcript from the scanner and passed this information to other journalists, who would synthesize all versions in their reports to their respective press agencies.

Not only did the Salvadoran government's COPREFA continually misrepresent events in El Salvador, but they made it very difficult for journalists to cover the war. In their desire to make the war zones off-limits to journalists, the Salvadoran army's press office demanded that journalists apply for written permission—called safe-conduct passes—to enter such zones, which included most of the country.

The passes had to be petitioned three days to a week in advance of the proposed visit. And more often than not, requests for passes were denied. As a result, it was



Rebel Radio Venceremos of the leftist FMLN is shown broadcasting from Perquon in northeastern El Salvador in February 1988. (Photo by Jeremy Bigwood)

impossible to cover breaking news like an attack or massacre outside the capital city. If one was caught in the countryside without an army pass, one could be arrested and deported, or even worse. Sometimes, aided by friendly peasants who were risking their lives, journalists would sneak into prohibited zones avoiding army foot patrols and aircraft, often at night, walking miles around roadblocks and military installations.

Even with a safe-conduct pass, journalists were required to check in at the local army base on entry into the zone and upon leaving. My first pass, after weeks of petitions, supposedly permitted me to go into guerrilla-controlled territory in Morazán, in the northeastern part of the country. When I arrived at a military base at the last roadblock, the soldiers summoned me to see the major. He told me that I could not go ahead unless I traveled with his troops. Not wanting to return empty-handed, I volunteered to go on a long-range patrol with a special CIA-trained force of Salvadoran PRAL (LERP) soldiers dressed as guerrillas (or, at least they thought they were dressed like guerrillas).

After being flown by helicopter to a hill where they were resting under shady mango trees, we ate canned rations and then commenced to walk in the hot, humid mountains. The radioman humped a radio in a backpack, and was straining under its weight. At dusk, we set up camp on another hill overlooking a farm. During the night, the officer, who called himself Charlie Cobra, called in an artillery strike through his radio operator. Soon we heard the whistling shell come closer and closer, and someone yelled "Incoming!" as it passed through the branches of an overhead tree,

exploding in an open field just below us.

Charlie Cobra yelled: "You imbecile, you've mixed up the coordinates! Call them back right now!"

As members of the PRAL huddled the ground, the nervous radioman called and changed the mixed-up coordinates, and the next shell flew clear of us.

Unlike the army, who used the old, heavy PRC-77 radio packs, the guerrillas used narrowband FM for most of their internal communications within a specific zone, or front—as they were called. Typically, the battery pack was cut out of a handheld, and a coiled telephone wire was attached to the poles within, which in turn was attached to a homemade battery pack containing easily obtainable C flashlight batteries. The homemade battery pack usually was placed in a pouch and attached to the belt of their ALICE harness, and the actual handheld clipped to a shoulder D-ring on the harness.

Besides being incredibly lightweight in comparison to the army's radios, this setup held the radio between the chest and the shoulder, a good position for monitoring or communicating. The guerrillas also used the large PRC-77 radios on shortwave frequencies—known to them as radio verdes (green radios)—for communications between zones. The guerrillas most often used numbered codes, those famous Spanish number stations of DX lore, hurriedly deciphering them with the latest code book.

The two guerrilla shortwave stations, Radio Venceremos and Radio Farabundo Marti, had the extremely difficult job of operating daily under wartime conditions in a country the size of Massachusetts. Because of the propaganda value to the

rebel cause, both radio stations were considered targets of the highest priority by the Salvadoran government and the U.S. counterinsurgency program. The Salvadoran Air Force, under direct control of the U.S. military's Southern Command, had the ability to deliver air strikes at any time to any location. Salvadoran army howitzers and mortars could deliver shells—on demand—to most quadrants in the country. In spite of overwhelming odds against them, Radio Venceremos broadcast twice daily during the 12-year-old war, missing only one day. As an excuse for their inability to destroy these stations, Salvadoran army and U.S. State Department spokesmen claimed that guerrilla broadcasts originated from Managua, Nicaragua.

This also presented the press and public a spurious mirror image of the CIA-operated Contra radio stations aimed at Nicaragua, which everyone knew to be operating out of safe, fixed radio stations in Honduras and Costa Rica. Many journalists had bought the government line. The only way for Radio Venceremos to prove to the public that they were operating out of El Salvador was to allow the press occasional access to them, a very dangerous proposition under their circumstances (at that time, the photo agency that hired me was allowing the U.S. government access to all of my images, although I wasn't aware of it).

Taking advantage of a UNICEF child inoculation trip to guerrilla country in northern Morazán, I was able to visit Radio Venceremos for the first time in February 1988. As the three men and two women members of Radio Venceremos set up in the living room of a house, one of the three other journalists who were present walked across the street and sat on the rubble of a bombed-out house—from where he could see, but not hear the broadcasters speaking. He turned on his small short-wave receiver, tuning it in to the low end of 6 MHz.

During live parts of the program, the announcers' voices synched with the words emanating from his receiver—proving to him, a doubter, that he was observing the real thing. Inside, I photographed the scene. Then, as the others left on the five-hour trip back to San Salvador, I stayed on to document life in this guerrilla zone. I didn't see Radio Venceremos for another month, but I heard them clearly throughout the whole zone where government jamming was more muted. I was to learn later that both radio stations, moving frequently to avoid detection, often used barbed-wire fences as their antennas. Radio Venceremos and its sister Radio Farabundo Martí continued to broadcast daily for the next four years from their mountain redoubts until the war ended in 1992 through U.N.-sponsored peace negotiations.

Since the signing of the Salvadoran peace accords, Radio Venceremos and Ra-

dio Farabundo Martí have moved to the capital city of San Salvador and now broadcast only on the FM band. Radio Venceremos is a popular commercial station, albeit with a decent news program. For news and analysis purposes, Radio Farabundo Martí is better. It is a shame that these two stations are not available on shortwave.

In this age of CNN and the Internet, scanning and shortwave DXing are given

the short-shrift, but in reality they are still a hidden, but essential part of news-gathering. Scanners usually are prohibited by governments with something to hide, but carefully taking the risk of using one can reveal stark realities. For journalists who cover wars where both sides have radio stations, and where access to actual events is difficult, the search for the truth about the conflict is greatly facilitated by DXing. ■



World's Most Powerful CB and Amateur Mobile Antenna*

**Lockheed Corp. Test Shows
Wilson 1000 CB Antenna Has
58% More Gain Than The
K40 Antenna (on channel 40).**

In tests conducted by Lockheed Corporation, one of the world's largest Aerospace Companies, at their Rye Canyon Laboratory and Antenna Test Range, the Wilson 1000 was found to have 58% more power gain than the K40 Electronics Company, K40 CB Antenna. This means that the Wilson 1000 gives you 58% more gain on both transmit and receive. Now you can instantly increase your operating range by using a Wilson 1000.

**Guaranteed To Transmit and Receive
Farther Than Any Other Mobile
CB Antenna or Your Money Back**
New Design**

The Wilson 1000 higher gain performance is a result of new design developments that bring you the most powerful CB base loaded antenna available.

Why Wilson 1000 Performs Better
Many CB antennas lose more than 50% of the power put into them. The power is wasted as heat loss in the plastic inside the coil form and not radiated as radio waves.

We have designed a new coil form which suspends the coil in air and still retains the rigidity needed for support. This new design eliminates 95% of the dielectric losses. We feel that this new design is so unique that we have filed a patent application on it. In addition, we use 10 Ga. silver plated wire to reduce resistive losses to a minimum.

In order to handle higher power for amateur use, we used the more efficient direct coupling method of matching, rather than the lossy capacitor coupling. With this method the Wilson 1000 will handle 3000 watts of power.

The Best You Can Buy

So far you have read about why the Wilson 1000 performs better, but it is also one of the most rugged antennas you can buy. It is made from high impact thermoplastics with ultraviolet protection. The threaded body mount and coil threads are stainless steel; the whip is tapered 17-7 ph. stainless steel. All of these reasons are why it is the best CB antenna on the market today, and we guarantee to you that it will outperform any CB antenna (K40, Formula 1, you name it) or your money back!

*Inductively base loaded antennas
**Call for details.

Lockheed - California Company

A Division of Lockheed Corporation
Burbank, California 91520

Aug. 21, 1987

Wilson Antenna Company Inc.
3 Sunset Way Unit A-10
Green Valley Commerce Center
Henderson, Nevada 89015

Subject: Comparative Gain Testing of Citizen's Band Antennas
Ref: Rye Canyon Antenna Lab File #870529

We have completed relative gain measurements of your model 1000 antenna using the K-40 antenna as the reference. The test was conducted with the antennas mounted on a 16' ground plane with a separation of greater than 300' between the transmit and test antennas. The antennas were tuned by the standard VSWR method. The results of the test are tabulated below:

FREQUENCY (MHZ)	RELATIVE GAIN (dB)	RELATIVE POWER GAIN (%)
26.965	1.30	35
27.015	1.30	35
27.065	1.45	40
27.115	1.60	45
27.165	1.50	41
27.215	1.60	45
27.265	1.75	50
27.315	1.95	57
27.365	2.00	58
27.405	2.00	58

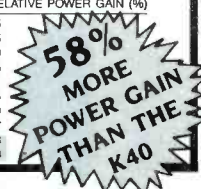

Individual test results may vary upon actual use.

CALL TODAY

TOLL FREE: 1-800-541-6116

FOR YOUR NEAREST DEALER

Wilson 1000

DEALERS Exclusive dealer areas still open

Roof Top Mount.....59⁹⁵

Trunk Lip Mount.....69⁹⁵

Magnetic Mount79⁹⁵

500 Magnetic Mount .59⁹⁵

Little Wil.....29⁹⁵

Wilson 2000 Trucker .59⁹⁵

Wilson 5000 Trucker .79⁹⁵

Call About Fiberglass!!!

Wilson
ANTENNA INC.

1181 GRIER DR., STE. A
LAS VEGAS, NV 89119

Monitor the Terrorist Threat!

Hear the Action From a Safe Distance, via HF/VHF/UHF

BY TOM KNEITEL, K2AES, SENIOR EDITOR

The Oklahoma City Federal Building, Pan Am Flight 103, Amtrak's Sunset Limited, the World Trade Center; Ulster, Israel and Saudi Arabia; subway systems in Japan and France. All conjure images of recent acts of terrorism. The motives behind each attack have differed, but terrorism continues to emerge as the preferred lethal way extremists press their sundry hostile agendas.

Terrorism may be motivated by revenge, religious fanaticism, political or many other reasons. It can be done by international organizations, or groups native to our own country. Regardless of the motive or nationality, acts of mass terrorism have several things in common: loss of life and destruction of property.

Terrorists aim to cause fear, panic and despair among the public; to disrupt the social structure, impact negatively upon the financial markets and break down governmental functions.

Terrorism in the United States has increased at an alarming rate within the past few years. Several hostile governments and groups are sneaking terrorists across our borders. Also, there are domestic groups directing their activities against our government or some element of our society.

The arsenal of terrorists includes weapons, bombs and explosive charges, as well as chemical and biological agents. U.S. Sen. Richard G. Lugar (R-Ind.) recently stated: "Americans have every reason to expect terrorist attacks by means of chemical and biological means before this decade is out."

Acquiring plutonium within the United States is virtually impossible. But with the breakup and denuking of the Soviet Union, an international black market in nuclear materials is developing with possibly ominous results here at home. As chilling as the specter of conventional terrorist bombs have been, authorities fear that they may just be a preamble to the ultimate horror, nuclear materials in the hands of terrorists capable of building a bomb and using it.

Iran, a nation that exports terrorism, is developing nuclear weapons that could be operational within three to five years.

Potential terrorist targets include federal property and buildings, airlines and airports, railroads, ports and harbors, mass transit systems, office complexes, hospi-



Terrorist acts are intended to create public confusion and fear, and destabilize governmental authority.

tals, public utilities, reservoirs, shopping areas, industrial sites, schools, refineries and the nation's infrastructure.

Counterterrorism Efforts

Many governments maintain anti-terrorist counterintelligence operations that exchange information internationally via Interpol and other means. Terrorist orga-

nizations and suspects are monitored as closely as possible in order to keep abreast of their plans, in the hopes of foiling mass terrorist acts. On the whole, these efforts have proven effective.

Nevertheless, as history has shown, there remain instances when terrorists manage to do their worst, despite the pains being made to hunt them down and put them on trial. In the United States, at such



A U.S. Army unit participates in a simulated fire rescue drill. (Army photo)

OUT OF THIN AIR AND INTO THE THICK OF THINGS.



THE DRAKE R8A

The Drake R8A World Band Communications Receiver. Turn it on, tune it in, and as easy as that, you're hearing world events as they happen... uncensored and complete. And with the R8A's astounding clarity, it's almost as if you're there. In fact, no other communications receiver puts you closer to the action in even the most distant parts of the world.

If you're a hobbyist, you'll marvel at the R8A's simplicity of operation. If you're an expert, you'll admire the high-powered features. The Drake R8A offers superior performance in a complete package that includes built-in filters and other unique features that have made Drake the foremost name in world band communications. The R8A from Drake...you've got to hear it to believe it.

DRAKE. FOR A WORLD OF DIFFERENCE.

Order Now Risk-Free!

15-DAY MONEY BACK TRIAL

We are so confident you'll be impressed with the R8A's performance, we'll give you a full refund on your factory direct order, less shipping charges, if the R8A doesn't meet or exceed your expectations. Call for complete details.

Order Today, Factory Direct or call for the dealer nearest you **1-800-937-2538**



DRAKE

R.L. Drake Company, P.O. Box 3006, Miamisburg, Ohio 45343, U.S.A. ■ Sales Office: 513.866.2421 ■ Fax: 513.866.0806 ■ Service and Parts: 513.746.6990 ■ In Canada: 705.742.3122
© 1995 The R.L. Drake Company

DRAKE is a registered trademark of The R.L. Drake Company.

CIRCLE 114 ON READER SERVICE CARD

www.americanradiohistory.com

times, the government swings into action to do whatever it takes to aid in the disaster, as well as investigate the crime scene.

Monitoring

That's when scanner (and even some shortwave) frequencies buzz with activity not normally heard. That means you could be in on what's happening, while wisely staying safely far from the scene. To aid you in doing this, there are frequencies you'll want to keep programmed, or at least on hand. These frequencies also would be used during simulated practice drills.

This is not intended to be an exhaustive compilation of every frequency used by each agency shown, but a representative sampling of frequencies most likely to display activity. These frequencies have been previously published, though not in the form presented here. Unless otherwise noted, all are FM mode. Some communications can be expected to be scrambled by digital means.

Frequencies

In 1984 and 1986, Congress passed legislation that provided for extraterritorial jurisdiction in terrorist-related incidents involved in hostage-taking and assaults against U.S. nationals traveling abroad. This legislation also authorized the Federal Bureau of Investigation to conduct appropriate investigations. The FBI is the lead law enforcement agency in the fight against domestic and international terrorism.

Presently, FBI communications appear to be widely spread out over frequencies across the entire 163 to 173 MHz range. The specific channels used differ for each local area and, therefore, are best determined by individual local searching. Many FBI transmissions are digitally scrambled, sounding like white noise.

Another important agency is the Bureau of Alcohol, Tobacco and Firearms, which is part of the Department of the Treasury. One of BATF's primary missions includes investigating violations of federal explosives laws. The agency's federal jurisdiction includes the following laws: 1968 Gun Control Act; 1970 Title XI of The Organized Crime Control Act; 1982 Anti-Arson Act (amended Title XI); and 1984 Comprehensive Crime Control Act (amended Gun Control Act).

Check for BATF agents on 165.2875, 165.4625, 166.5375, 165.9125, 166.4625, 418.175, and 418.725 MHz.

The Federal Emergency Management Agency ensures the continuity of government and coordinates mobilization of resources during national security emergencies. As such, FEMA supports state and local governments in a wide range of disaster planning, preparedness, mitigation, response and recovery efforts.

Among FEMA's many scanner band fre-



Airlines have been forced to take extraordinary security precautions because of the spreading terrorism threat.

quencies, any or all of the following might be locally active in the immediate aftermath of an act of terrorism: 138.225, 138.575, 139.450, 139.775, 139.825, 139.950, 140.025, 141.725, 142.350, 142.425, 142.975, 143.000, 168.075, 168.100, 168.400, 168.700, 169.600 and 169.875 MHz.

In conjunction with the U.S. Air Force, FEMA participates in the Joint Emergency Evacuation Plan, or JEEP. JEEP's intention is to evacuate and safely relocate top government officials in the event the government comes under attack. Monitor 268.000, 287.600 and 293.500 MHz for JEEP's operations.

FEMA's Urban Search and Rescue Task Forces use the following frequencies: 408.5125, 409.4875, 410.4875, 410.5125, 413.2125, 416.0375, 416.8125, 416.9375, 417.5875 and 417.6625 MHz.

On the HF bands, FEMA uses USB mode. Its primary daytime calling frequency is 10494 kHz, while at night it is 5212 kHz. Numerous working frequencies are utilized, but it's worth keeping an ear peeled to nationwide point-to-point channels, like: 6109, 7349, 14451, 14777, 14837, 14886, 14900, 14909 and 20028 kHz. Other agencies also participate in these HF nets, including the De-



Scanner monitoring allows hearing the action from a safe distance. Also, it keeps the casually curious out of the way of busy on-site emergency and investigative personnel.

Best Price, Best Service, Best Total Value...Guaranteed. If You Find A Better Value, Give Us A Call!

ICOM

We Stock The Full Line!



**INTRODUCING OUR
NEW RADIO
SERVICE CENTER**

**AVVid Announcement:
FOR IMMEDIATE RELEASE...
AVVid Amateur Radio Repair,
an Authorized Kenwood
Service Center, has joined
Tucker Electronics
Radio Service Center.
Call 1-800-214-5779 for all your
Kenwood Warranty and Non-
Warranty Radio Repairs.**

KENWOOD

We Stock The Full Line!



**Optoelectronics
Scout 40
\$399**
Frequency Scout
The Scout 40 can record up to 250 hits on each channel and store into memory 400 unique frequencies (10 MHz to 1.4 GHz). Features Digital Filter/Auto Capture and the ability to automatically Reaction Tune or Memory Tune many receivers. 10 digit LCD, EL backlight, and 16 segment signal strength bargraph. Includes NiCad batteries, AC adapter/charger and PC utility disk.

**The Peak Performer
Entirely Unrivaled In The Hand-Held
Scanner World
AOR AR8000..... \$599**
All Mode Wide-Band Radio Receiver
Covers 500 kHz-1900 MHz tuning (870-890 MHz cellular blocked) in 50 Hz steps. ALL MODE reception supports AM, USB, LSB, CW, NFM, and WFM modes. If you're new to scanning, this scanner can be set to New User Mode, easier-to-use than ever, while Expert Mode can be used when you're ready for it. A computer-control option is available for those interested in computer controlled scanner operation. If you want the hottest hand-held scanner around, this is the one for you!

Ramsey SCN-1..... \$49⁹⁵
800-950 MHz Scanner Converter Kit
The SCN-1 converts uninterrupted 800 to 950 MHz frequencies down to 400 to 550 MHz which is tuned by your regular scanner.
Hook-up is very easy, just connect your antenna to the SCN-1 and jumper the SCN-1 output to your scanner antenna jack- that's it! And, if you don't have an antenna good for the 800 to 950 MHz band, we even give you instructions on how to build a low cost, yet great performance antenna! (Case Not Included)
CSCN: Matching case and knob \$14.95
SCN-IWT: Wired and tested kit..... \$89.95

Trade In Your Used Test Equip. For New Radio Equip!

**CALL FOR TRADE QUOTES
800-527-4642**

AOR AR2700... \$399
Wide-Band Radio Receiver
What an amazing breakthrough in value for under \$400! This full featured unit combines the important features of wide band coverage, auto-mode bandplan data (with override), fast scan search rates & ease of operation with the latest innovations of optional computer control, and clone of data. There is even an option available that records 20 seconds of audio directly off the air for playback! This receiver covers the frequency range from 500 kHz to 1300 MHz* and gives you 500 channels to put those frequencies in! Features: Auto-Mode tuning, AM, NFM & WFM. Optional voice recording, computer control, and data clone between sets.

Call, Write or Fax For Your Copy Of Our Newest Catalog

FREE! **FREE!**

**CATALOG REQUESTS
800-527-4642**

To Order Call: 800-559-7388

T TUCKER
ELECTRONICS

1801 Reserve Street, Garland, TX 75042 • P.O. Box 551419, Dallas, TX 75355-1419 • In Dallas: 214-348-8800 • Fax 24 hs. in English, Spanish, Francais, und auf Deutsch: 214-340-5460



CIRCLE 160 ON READER SERVICE CARD

www.americanradiohistory.com

introducing...

CQ VHF Ham Radio Above 50 MHz

Something this good could only come from
the publishers of **CQ** ...

A NEW magazine for all ham radio operators who are active or interested
in operating on the amateur bands above 50 MHz!



In every issue you'll find...

- Operating articles
- Technical articles
- Beginner's articles
- Product reviews
- Projects you can build
- New things to try
- News and Columns

and topics like...

- Repeaters & FM
- Packet radio
- Amateur satellites
- Amateur television
- VHF/UHF "weak signal"
- and much more!

12 great issues ~~ONLY \$21.95~~

\$19.95 *Introductory price*

SUBSCRIBE TODAY *and receive the premiere issue!*

TAKE ADVANTAGE OF THIS SPECIAL COMBO OFFER!

Here's what you get:

12 issues of CQ VHF at the introductory price (regular subscription rate \$21.95)	\$19.95
12 issues of CQ The Amateur's Radio Journal (this offer can be used on renewals)	\$24.95
The 1996 CQ Equipment Buyer's Guide	FREE (\$5.95 value)



GET ALL THREE! ONLY \$44.90

ORDER TOLL FREE! 800-853-9797

Or to order by mail, use the order form and the postage paid return envelope in this issue.

CQ Communications, Inc. 76 North Broadway Hicksville, New York 11801

FAX (516) 681-2926



Specialized U.S. Army units are trained in toxic gas and explosive ordnance disposal. (Army photo)

partment of Energy and the Nuclear Regulatory Commission. FEMA's HF stations can be picked out by their distinctive call letters, consisting of WGY9 and two more digits (i.e., WGY935, WGY997, etc.).

To counter the threat of nuclear terrorism, the Department of Energy created the Nuclear Emergency Search Team, or NEST. NEST is our nation's nuclear bomb squad, comprised of a highly mobile team consisting of weapons designers, engineers and physicists. These experts are NEST's volunteers. Its primary mission is searching for and locating reported nuclear bombs planted by terrorists. When such a device is located, the U.S. Army's Explosive Ordnance Disposal (EOD) unit is brought in to render the device harmless.

NEST is headquartered in Alamogordo, N.M., but it can be made ready in short order to be flown to any city. Realistic practice drills are regularly held in various cities to keep NEST members well trained.

NEST communications may be on: 150.450, 163.000, 164.025, 164.100, 164.225, 164.2375, 164.775, 166.225, 167.825, 167.850, 167.950, 169.600, 169.675, 172.300 and 410.800 MHz. U.S. Army EOD units are reported using the following: 49.70, 49.80, 139.000 and 139.175 MHz.

The General Services Administration's Public Buildings Service maintains its own large police force. This uniformed force provides physical security at many federal buildings and other U.S. Government facil-

ities. As such, the frequencies of GSA's Special Police are worthy of monitoring in connection with counterterrorist activities.

Monitor the GSA's Special Police on: 412.400, 415.200, 417.200 and 417.425 MHz.

National Transportation Safety Board investigators use handheld units. They are reported on 165.7625 and 166.175 MHz.

Also of interest are those channels shared by numerous federal agencies. These include the federal agency itinerant frequencies 163.100, 418.050 and 418.575 MHz; the federal interagency common frequencies 168.350, 408.400 and 418.075 MHz; the National Radio System on 164.8625 and 165.6625; the Federal Disaster Network frequency, 170.200; plus the National Interagency Incident Management System frequencies of 168.550 and 168.650 MHz.

Various area civil public safety agencies often communicate with one another on 39.48, 45.86, 45.88, 154.265, 154.280, 154.295, 866.0125, 866.5125, 867.0125, 867.5125 and 868.0125 MHz.

Comms relating to the detection, containment, neutralization, and/or removal of hazardous or pollutant substances from the environment may be monitored on: 36.25, 36.71, 36.89, 41.71, 122.925, 150.980, 154.585, 156.750, 157.075, 158.445, 162.025, 162.125, 162.175 and 164.450 MHz.

Ambulances and medical communications are best monitored on the following: 155.340, 462.950 to 463.175, and 467.950 to 468.175 MHz. The American Red Cross uses 47.42 MHz as its primary nationwide channel.

Expect that frequencies other than these also would be used during a particular act of terrorism, while some frequencies listed here would not be used in your area. But you have enough data to let you stay informed, while remaining out of the way of emergency and investigative personnel working at the scene. Be thankful you don't have to be there in person.

Some of these frequencies are predominantly active during emergencies and drills, while others are used daily for routine comms. ■

Timestep

The Weather Satellite System

Images available as often as every 4 minutes.

Full screen color animation of up to 1000 frames.

Direct temperature readout.

Latitude / Longitude and political boundaries.

Easy to use mouse operation.

3D Cloud images.

Automatic operation.



HRPT Image of southern Hudson Bay

If you want to see the world's weather right now from anywhere in the world, including the Americas, Europe, the Middle East, Japan and Australia, then we have a system for you. Watch local weather systems or track hurricanes and tropical storms. We can supply simple systems for beginners or advanced HRPT systems for enthusiasts. All component parts are available separately. Systems and satellites available include HRPT, WEFAX, APT, NOAA, Meteor, Okean, GOES, Meteosat and GMS. Color brochures available.

Spectrum International Inc. PO Box 1084 Concord Mass. 01742 USA
Tel. (508) 263-2145 Fax. (508) 263-7008

Manufactured by: Timestep PO Box 2001 Newmarket CB8 8XB England
 Tel. 01440 820040 Fax. 01440 820281

CIRCLE 75 ON READER SERVICE CARD

DXing 60 Meters

These Shortwave Stations Around 5 MHz Offer a Challenge

BY GERRY L. DEXTER

Shortwave's 49-, 31-, 25-, 22-, 19- and 16-meter bands, dominated by the high-power international broadcasters, are areas where many SWLs spend most of their listening and DXing time. Many rarely, if ever, venture much above (or below, frequencywise) the 49-meter band. Sixty meters, for example, is a land of generally weaker signals, where less English is spoken, and where some really challenging DX targets await. It's understandable that beginning SWLs would want to avoid this more treacherous area. For many veteran listeners, however, this is the place they most enjoy tuning.

Besides being a prime DX hunting ground, 60 meters is attractive because it still retains much of the romance of shortwave—an undefinable feeling that many international broadcasters seem to have lost in their effort to sound more and more like “regular” broadcasters.

Our hope is to get you to give 60 meters a try, or spend more time there if you presently try that range only occasionally. What we're going to do is take an alphabetical, country-by-country tour of this frequency range.

Technically, the 60-meter band extends from 4700 to 5100 kHz but we're going to cover stations on frequencies down to 4000 kHz, which, actually, is the upper end of the 75-meter band. We'll also cover up to a 100 kHz or above the top end of

60 meters. Most shortwave broadcast DXers look at this frequency range as a single entity, particularly because it reacts similarly to propagation conditions, and there's no really obvious break point.

Seeking signals in this range is somewhat different from, say, the 9-MHz band because, by and large, you can forget about spending very many daytime hours here. The band is open mostly from the late afternoon, through the hours of darkness (which, perhaps, lends it part of its mystique) and goes “out” an hour or so after local sunrise. SWLs who live in the eastern part of North America will (especially in the winter months) find many signals from Africa showing as early as 1900. If you live on the West Coast you'll have to wait several hours beyond that before the band begins to open and, by that time the Africans will have signed off. You'll have to catch them at sign-on, generally between 0300 and 0600. West Coasters will have better shots at Asian and Pacific signals, though.

Asia, Africa and Latin American stations are all over the place, while Europe is barely represented. Eastern and Midwestern listeners, particularly during the winter months, often can hear African stations signing on late at night, then signing off late in the afternoon. The same is true with Latin American signals: We hear sign-offs late in our local evenings and later

catch their early morning sign-ons.

Reception quality can vary from day to day and season to season even more than it does on the higher bands. You'll generally find the best reception from local Indonesian stations in the spring and fall and from the subcontinent in late fall and winter. Latins are reliable year 'round, although summertime means contending with more static (QRN).

Some countries can be heard quite easily, requiring more than just tuning to the right frequency at the right time. Other stations are a lot chancier, a few are as close as you can get to being impossible. Doing serious DXing, especially on lower frequency bands like this, requires a great deal of patience. A lot of time must be spent tuning and searching through evening and early morning hours in all seasons in order to get a feel for how the band performs in your area over a year's time. Seeking a particular station may require frequent checks for a period of weeks or months—occasionally even years!

It's a very good idea to keep a log by frequency, including time heard, sign-on or sign-offs noted and the like. As you identify more and more stations, you'll find such a log makes it much easier to spot signals you haven't yet heard.

We've tried, in a very general way, to indicate the reception possibilities for each country: one star (easiest), two (fairly or



WWVH, Hawaii, can be found under WWV on 5000.



Radio Togo is a frequent visitor on 5047.

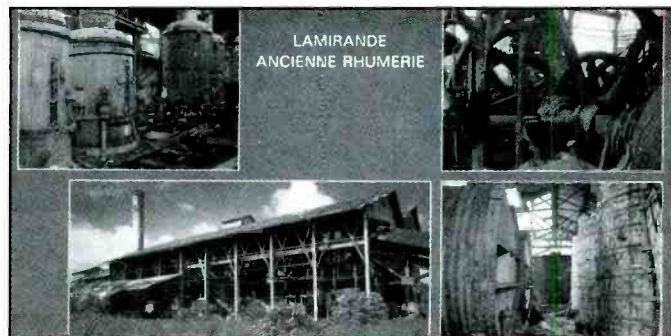

▲ RFO-Cayenne, French Guiana, operates 24 hours a day on 5055.

◀ Republic of Iraq Radio on 4615 often is tough to hear away from the East Coast.

quite difficult) or, three (extremely difficult or nearly impossible to hear). Obviously, these are subjective indicators and your location may increase or lessen your chance of hearing a particular country, so keep in mind that these are intended only as a general guide.

ANGOLA (***) There was a time when there were several Angolan regional stations active on 60 meters. Now it's down to one or two and, even at that, operation tends to be irregular. Try Radio Nacional from Luanda on variable 4950 around 0300 (in Portuguese). Emissora Provincial de Benguela on 5043 sometimes is heard from 0500 sign-on.

ARMENIA (*) Armenian Radio almost is never reported, (at least in North America) on its 60-meter, 4810 channel, scheduled for an 0200 sign-on with its 50-kW domestic service.

AUSTRALIA (***) Commonly heard on the higher bands, Australia has become difficult DX down here, especially since 4920 went silent. You'll have to chase the stations of the Northern Territory Shortwave Service: VL8A (Alice Springs) on 4835, VL8T (Tennant Creek) on 4910 and VL8K (Katherine) on 5025. All three run until 0830, normally a bit early for reception from the Pacific, though it's a different story for West Coast DXers.

AZERBAIJAN (***) Azerbaijan Radio-TV from the capital, Baku, has two shortwave transmitters using 60 meters—4785 and 4957.5. Neither is an easy catch, but they sometimes can be picked up during local early mornings.

BANGLADESH (***) Combine a frosty winter morning with the right propagation conditions and you may locate a signal from Radio Bangladesh on 4880. It signs on about 1145, goes off an hour later, then returns briefly at 1300.

BENIN (*) Radio Benin (the long version is Office de Radiodiffusion et Televi-

sion du Benin) from Contonou, often is well heard during good African conditions, signing on at 0458 on 4870. A bigger challenge is the regional station at Parakou on 5025, signing on at 0500.

BOLIVIA (*) 60 meters has a heavy Bolivian station population and most of them are at about the same level as far as "hearability" goes. A couple of the more often reported are Radio Santa Ana, 4649 variable; Radio Abaroa, 4712 variable; and La Cruz del Sur, 4875. Try during the evening or at sign-on which, depending on the station, may be 0900, 1000 or 1030. Sign-on times can vary from day to day.

BOTSWANA (***) Radio Botswana on 4820 is famous for its barnyard sound effects interval signal (the cow effects were human-made) aired before their 0300 sign-on. Unfortunately, La Voz Evangelica in Honduras still is in operation at that hour, so we don't hear Botswana on this frequency as often as in the past.

BRAZIL (*) 60 is a gold mine for Brazilians. Here are some of the easier ones: 4755, Radio Educacao Rural; 4805, Radio Difusoras Amazonas; 4875, Super Radio Roraima; 4885, Radio Clube do Para; 4985, Radio Brazil Central; and 5045, Radio Cultura do Para. Note that some frequencies are used by two or even three Brazilian stations simultaneously, so beware. Try tuning in evenings or early mornings at 0800 and 0900 sign-ons.

BURKINA FASO (*) Radiodiffusion Nationale du Burkina operates a 50-kW transmitter on 4815 and signs on at 0530. Broadcasts are in French.

BHUTAN (***) Radio Bhutan is a prime DX target on 5030 (sometimes 5025). The most likely shot is around local dawn (during its 1100-1600 broadcast period).

CAMBODIA (***) Rare is the National Voice of Cambodia, operating on 4907 (varying to 4910). Best bet is around local dawn, during its 1100-1500 schedule.

CAMEROON (*) For years you could hear a half-dozen Cameroon stations in this range, but lately Cameroon shortwave has been suffering though difficult times. At present, it's believed that only the regional station at Garoua on 5010 is active (and perhaps only intermittently, at that). Sign-on is at 0530 in French.

CENTRAL AFRICAN REPUBLIC (*) Radiodiffusion Television Centrafricaine opens its daily broadcasts in French at 0430 on 5034. Its 100-kW signal can be received quite well during good openings to Africa.

CHAD (*) (or Tchad if you prefer) The main government station at N'Djamena signs on at 0425 on 4904.5. Radio Moundou, a regional station from the town of the same name, operates on 5287 from 0500.

CHINA (*) China has several stations making use of the 4- and 5-MHz range, which are best heard during the local early morning, up to a half-hour or so after sunrise. Check 4220, 4330 and 4500 (all from Urumqi), 4760 (Kunming), 4975 (Fuzhou), 4990 (Changsha), 5010 (Nanning), 5020 (Nanchang), all CPBS stations. Also the Voice of Pujiang from Shanghai on 4950.

COLOMBIA (*) There are a number of Colombians broadcasting in this range: Ondas del Meta, 4885; Radio Nacional, 4955; and the inescapable Caracol Colombia, 5075.

CONGO (***) Radiodiffusion Television Congolaise at Zaire is one of those on-again, off-again operations (more the latter). When they have the transmitter operating, they sign on at 0400 on 4765 carrying the national network in French.

COSTA RICA (*) One of the oldest Costa Rican shortwave stations, Radio Reloj, still holds forth on 4832 variable with announcements and time checks every minute. Evenings. In Spanish.

CUBA (*) Radio Rebelde, 5025, in

VERIFICATION CARD

QSL.

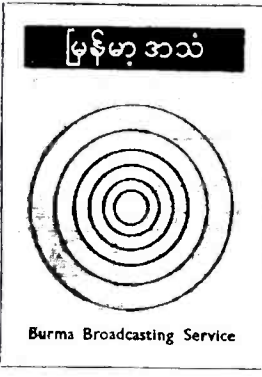

Burma Broadcasting Service

Location... U.S.A.

Wavelength... 7.985 kHz

Date... 26 12 86

Time... 15:30 (GMT)

Your reception report has been examined and found correct/~~incorrect~~.

 Director (Broadcasting)
 Information and Broadcasting Department,
 Rangoon, Burma.



Radio Myanmar, formerly the Burma Broadcasting Service, sometimes can be heard in the early mornings on 4725.

Senegal, on 4890, is a chancier catch than it used to be.

Spanish during the evenings.

DJIBOUTI (**) Radiodiffusion-Television de Djibouti always has been one of the tougher 60-meter Africans, usually buried under another broadcaster or a FEMA transmission, or both. At the moment, it's inactive, which makes it an even tougher log! One day it may return so it might pay to check for the French language sign-on at 0300. You never know.

DOMINICAN REPUBLIC (*) You have a couple of opportunities here. Try evenings for Onda Musical on variable 4780; La N 103 (relaying a local FM station) on 4800 variable; Radio Barahona, 4930; and Radio Cima, 4960.

ECUADOR (*) There are lots of Ecuadorian opportunities. Best are: Centinela del Sur, 4770; Radio Popular (Independiente), 4800; and Radio Quito, 4920.

EQUATORIAL GUINEA (**) Radio Nacional at Bata operates on either 4925.5 or 5004 from 0430 sign-on in Spanish. Incidentally, some country lists (that of the North American Shortwave Association, in particular) count this as Rio Muni and the station at Malabo on 6250 as Fernando Poo, which were separate entities before they became Equatorial Guinea.

FRENCH GUIANA (**) RFO Guyane uses 5055 24 hours a day. Sometimes evening or early morning reception can be quite good.

GABON (*) Radio France International's Gabon relay is the easiest of two possibilities, operating on 4890 at 0400. Try also the Gabon government station at Libreville on 4777 from 0455.

GHANA (*) Ghana Broadcasting Corp. signs on at 0340 on 4915, carrying the Radio One service, which includes some English.

GEORGIA (**) Georgian Radiom—from Tbilisi—uses 5040 for its domestic

service for most of the day and night. Logs of this one are very rare. Sign-on is at 0200; the channel is usually occupied by one or more Latin stations.

GUINEA (*) Radiodiffusion Television Guineenne from Conakry normally operates on 4900 with sign-on in French at 0555, but it may be inactive at the moment.

GUATEMALA (**) Several religious/cultural stations are active from Guatemala. The easiest to hear surely is Radio Tezulutlan from Coban on 4835, aired evenings (to around 0330) and mornings (to 1400 or fadeout).

HAWAII (*) The voice of the lady announcer giving the time signals under WWV, 5000, comes from WWVH, Hawaii, 24 hours a day.

HONDURAS (*) La Voz de Evangelica, 4820, can be heard in the evenings. Second choice: Radio Internacional, 4930v.

INDIA (*) All India Radio has several outlets in the 60-meter band, all of which are most likely to be heard during the winter months around your local dawn: AIR-Hyderabad, 4800; AIR-Calcutta, 4820; Bombay, 4840; Kohima, 4850; Delhi, 4860 (one of the more common shows), and several others.

INDONESIA (*) Having been divided into several "radio countries," this country adds interest to the DX challenge. These Radio Republik Indonesia regionals will be heard mostly around dawn, especially in the spring and fall: 4719 (alternately 4753), Ujung Pandang (Sulawesi); 4777, Jakarta (Jawa); 4805, RRI Kupang (very low power, Timur); 4835, Ambon (Mulu); 4855, Palembang (Sumatera); and 4875, Sorong (Irian Jawa). Ujung Pandang, 4719 or 4753, will be the easiest to hear.

IRAQ (**) Republic of Iraq Radio uses 4615 from 0300 sign-on in Arabic. The broadcasts are jammed.

IVORY COAST (*) (Cote D'Ivoire) Radiodiffusion Television Ivoirienne used to be one of the old reliables for 60-meter Africans (you could rely on them not to verify, too!). They still are scheduled on 4940 carrying the first program (Chaîne 1) from 0455, but reception (and perhaps operation) is spottier than it used to be.

KAZAKHSTAN (**) Kazakh Radio uses several 60-meter frequencies between 0000 and 2000: 4545, 4800, 4820 and 5035 for its local services. None are easily heard in North America. Try around local dawn.

KENYA (**) Kenya Broadcasting Corp. is anything but a regular visitor for most SWLs, but every now and then the propagation gods smile and we enjoy reception from this East African station. It signs on at 0200 on 4885 and 4935. East Coast residents probably will be able to hear this up to its 2100 sign-off as well.

LESOTHO (*) Radio Lesotho, Maseru, often can be picked up at its 0300 sign-on, on 4800. Most of the broadcast is in the national language SeSotho. English news is scheduled at 0600.

LIBERIA (*) Religious station ELWA operates from Monrovia on 4760 from 0600 sign-on.

MADAGASCAR (**) Radio Television Malagasy currently is being heard on 5009 variable from 0300 sign-on in Portuguese. This is one of those stations that is heard well for a time and then becomes a nearly impossible catch, depending on conditions and the time of year.

MALI (*) Radiodiffusion Television Malienne signs on in French at 0555. Try 4783 and 4835, both slightly variable. During the winter, listeners in the eastern and central time zones should be able to receive this until its 0000 sign-off.

MAURITANIA (*) Radio Mauritanie, Nouakchott, signs on at 0630 on 4845.

Scanners/CB/Weather Stations

New Scanner Products Available

Now it's easy to purchase communications, emergency management supplies, weather forecasting equipment and more directly from Communications Electronics Inc. Your free fax-on-demand catalog including unadvertised specials is instantly available by calling 313-663-8888 from your fax machine.

Bearcat Scanners

Monitor police, fire, marine, aircraft, emergency medical transmissions and more with a Bearcat scanner.

Bearcat 9000XLT-U base/mobile	\$369.95
Bearcat 3000XLT-U handheld	\$344.95
Bearcat 890XLT-U base/mobile/weather alert	\$227.95
Bearcat 860XLT-U 100 channel base	\$154.95
Bearcat 760XLT-U base/mobile	\$189.95
Bearcat 700A-U information mobile	\$144.95
Bearcat 560XLA-U base/mobile	\$76.95
Bearcat 220XLT-U handheld/SPECIAL	\$207.95
Bearcat 178XLT-U base with weather alert	\$124.95
Sportcat 150-U handheld with 800 MHz	\$158.95
Bearcat 148XLT-U base with weather alert	\$83.95
Bearcat 120XLT-U handheld	\$129.95
Bearcat 80XLT-U handheld with 800 MHz	\$144.95
Bearcat BCT7-U information mobile	\$168.95

Weather Stations

Now you can be your own weather reporter with the Davis Weather Monitor II. Our top-of-the-line weather station combines the most advanced weather monitoring technologies available into one incredible package. Glance at the display, and see wind direction and wind speed on the compass rose. Check the barometric trend arrow to see if the pressure is rising or falling. Push a button, and read indoor and outdoor temperature, wind chill, humidity and barometric pressure. Our package deal includes the new ultra high resolution 1/100 inch rain collector part #7852-U, and the external temperature/humidity sensor, part #7859-U. The package deal is order #DAVI-U for \$479.95 plus \$15.00 shipping. If you have a personal computer, when you order the optional Weatherlink computer software for \$139.95, you'll have a powerful computerized weather station at an incredible price. For the IBM PC or equivalent order part #7862-U. Apple Mac Plus or higher including PowerBook, order part number 7866-U.

The Weather Monitor II (7440) comes complete with 40 feet of cable, external temperature sensor with 25 feet of cable, junction box with 8 feet of cable, AC power adapter, detailed instruction booklet and one year limited factory warranty.

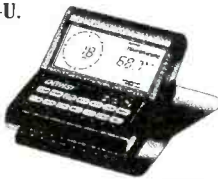

Davis Weather Monitor II 7440-U	\$334.95
Davis Weather Wizard III 7425-U	\$154.95
Davis Perception II Indoor station-alone weather monitor 7400-U	\$124.95
Davis Remote Display Unit 7815-U	\$84.95
Davis Rain Collector II 0.01" 7852-U	\$59.95
Davis Rain Collector II 0.2 mm 7852METRIC-U	\$59.95
Davis Rain Gauge Stand-alone 0.01" 7520-U	\$79.95
External Temperature/Humidity Sensor 7859-U	\$99.95
Davis Anemometer Mast Mount 7890-U	\$15.95
Weatherlink Software for IBM PC/Version 3.0 7862-U	\$139.95
Weatherlink Software for Apple/Version 3.0 7866-U	\$139.95
4-Conductor 40' (12.2 m) extension cable 7876-U	\$17.95
6-Conductor 40' (12.2 m) extension cable 7878-U	\$21.95
8-Conductor 25' (7.6 m) junction box cable 7880-U	\$14.95
8-Conductor 50' (15.2 m) junction box cable 7881-U	\$24.95
8-Conductor 100' (30.5 m) junction box cable 7882-U	\$44.95
Modem Adaptor 25-lin for communications port 7870-U	\$9.95
Car/Boat/RV Lighter Power Cord 7873-U	\$9.95
2400 baud modem for Weatherlink MEXT-U	\$29.95
Talking weather card - Call 313-994-9000 for demo IT1-U	\$474.95
Weatherlink language disks: Franaise, Deutsche, Italiana, Espaola 7863-U	\$24.95
Barometer, Indoor Hygrometer & Thermometer, Clock/Calendar BAK88-U	\$89.95
Indoor-Outdoor Thermometer/Barometer & Hygrometer by OSI BA213-U	\$79.95
Thermometer with transparent calendar & clock display by OSI CT188-U	\$19.95
Thermometer with AM/FM clock radio by Oregon Scientific CR388-U	\$39.95
Indoor/Outdoor Thermometer with Jumbo Display by OSI JB880EX-U	\$24.95



Bearcat® 9000XLT-U Radio Scanner

Mfg. suggested list price \$769.95/CE Special \$369.95
500 Channels • 20 banks • Alpha numeric display
Turbo Scan • VFO Control • 10 Priority channels
Auto Store • Auto Recording • Reception counter
Frequency step resolution 5, 12.5 & 25 KHz.
Size: 10-1/2" Wide x 7-1/2" Deep x 3-3/8" High

Frequency Coverage:
25,000-549,995 MHz., 760,000-823,995 MHz.,
849,0125-868,995 MHz., 894,0125-1,300,000 MHz.

The Bearcat 9000XLT gives you pure scanning satisfaction with amazing features like TurboSearch™ to search VHF channels at 300 steps per second. This base and mobile scanner is ideal for surveillance professionals because it has a selectable attenuator to help eliminate annoying intermodulation from adjacent frequencies in highly populated areas and selectable AM, Wide FM and Narrow FM modes that allow you to change the default receiving mode of the BC9000XLT. Other features include **Auto Store** - Automatically stores all active frequencies within the specified bank(s). **Auto Recording** - This feature lets you record channel activity from the scanner onto a tape recorder. **Hi-Cut filter** to help eliminate unwanted static noise. You can even get an optional **CTCSS Tone Board** (Continuous Tone Control Squelch System) which allows the squelch to be broken during scanning only when a correct CTCSS tone is received. For maximum scanning enjoyment, order the following optional accessories: PS001 Cigarette lighter power cord for temporary operation from your vehicle's cigarette lighter \$14.95; PS002 DC power cord - enables permanent operation from your vehicle's fuse box \$14.95; MB001 Mobile mounting bracket \$14.95; BC005 CTCSS Tone Board \$54.95; EX711 External speaker with mounting bracket & 10 feet of cable with plug attached \$19.95. The BC9000XLT comes with AC adapter, telescopic antenna, owner's manual and one year limited warranty from Uniden.

CB/GMRS Radios



The Maxon GMRS 210+3 transceiver is a PLI synthesized 10 channel radio on General Mobile Radio Service frequencies. It's the ideal radio for long range communications. Two repeater channels are programmable and one channel (462.675 Mhz.) is set aside for emergency and safety communications. The seven remaining interstitial frequencies 462.5625, 462.5875, 462.6125, 462.6375, 462.6625, 462.6875, 462.7125 Mhz are all-purpose GMRS radio channels. 2 watts of RF power for exceptional transmitting range. Up to 5 watts when used with the supplied 12 volt vehicular DC power cord. CTCSS built-in. Includes 450mAh Ni-cad rechargeable battery pack, AC/DC wall battery charger, owner's manual, FCC license application, belt clip, antenna. Call 1-800-USA-SCAN to order.

Maxon GMRS210+3-U GMRS transceiver	\$188.95
SPECIAL Buy 2 or more GMR210+3 at \$174.95 each	
WTA3DTU Ni-cad battery charger for WTA6GN4 & WTA6GN2	\$58.95
WTA6GN4-U Ni-cad pack gives 4 watts power with 210+3	\$55.95
WTA6GN2-U Ni-cad pack gives 2 watts power with 210+3	\$29.95
WTA6GA-U Alkaline battery case - requires 6 AA batteries	\$9.95
WTA8GA-U Carrying case for Maxon GMRS210+3	\$29.95
WTA10G-U Speaker/microphone for Maxon GMRS210+3	\$18.95
WTA13G-U Push-to-talk mini-VOX headset for GMRS210+3	\$47.95
WTA14-U Antenna adaptor/screw-in male to BNC connector	\$9.95
ANT4GM-U 1/4 wave UHF magnetic mount mobile antenna	\$29.95
Cobra 2010GTLWX-U SSB base with weather alerts \$379.95	
Cobra 148FGT-U CB with frequency counter	\$209.95
Cobra 291TDWX-U CB with weather alert	\$114.95
Cobra HI40-U CB 40 channel handheld transceiver	\$99.95
Ranger RC12950-U 25 watt 10 meter transceiver	\$239.95
Uniden GMR100-U GMRS handheld transceiver	\$144.95
Uniden WASHINGTON-U SSB CB Base († \$25.00 shipping)	\$199.95
Uniden GRANTXL-U SSB CB Mobile	\$139.95
Uniden PRO538W-U CB & Weather	\$59.95



VHF Transceiver

RELM® WHS150-U Transceiver/SPECIAL

Mfg. suggested list price \$481.67/CE price \$299.95

Police and fire departments depend on the RELM WHS150 transceiver for direct two-way communications with their police, fire department, civil defense agency or ham radio repeater. The WHS150 is our most popular programmable five watt, 16 channel handheld transceiver that has built-in CTCSS, which may be programmed for any 39 standard EIA tones. Frequency range 148.000 to 174.000 MHz. Will also work 144.000-148.000 with slightly reduced performance. The full function, DTMF compatible keypad also allows for DTMF Encode/Decode and programmable ANI. Weighing only 15.5 oz., it features dealer programmable synthesized frequencies either simplex or half duplex in both 5.0 and 6.25 KHz increments. Other features include scan list, priority channel, selectable scan delay, selectable 5 watt/1 watt power levels, liquid crystal display, time-out timer and much more. When you order the WHS150 from Communications Electronics Inc., you'll get a complete package deal including antenna, battery, belt clip and user operating instructions. Other accessories are available. A leather carrying case with swivel belt loop part #LCWHS is \$49.95; rapid charge battery charger, part #BCVHS is \$69.95; speaker/microphone, part #SMWHS is \$54.95; extra ni-cad battery pack, part #BP007 is \$59.95. The radio technician maintaining your radio system must order programming instructions part #P1150 for \$18.00 to activate this radio. FCC license required for United States operation.

Other neat stuff

PH5000-U Waber 500VA/340 Watt computer uninterruptible power supply \$159.95	
WX70-U weather radio with National Weather Service storm alert	\$29.95
WB-U USA Today The Weather Book, Guide to USA weather by Jack Williams \$15.95	
PSUN-U Parly Sunny, Weather Junkie's Guide to Weather by Alan Fields	\$11.95
Grundig Yacht Boy 400-U digital portable shortwave - 40 memory	\$179.95
Grundig Yacht Boy 230-U portable shortwave receiver	\$109.95
Sangean ATS800-U portable 20 memory shortwave receiver	\$69.95
Sangean ATS803A-U portable shortwave w/AC adapter - 9 memory	\$129.95
Sangean ATS808-U portable 45 memory shortwave receiver	\$129.95
Uniden EXP9200-U 900 MHz. 1 or 2 line spread spectrum cordless phone	\$289.95
Uniden EXP100-U 900 MHz. 1 line cordless spread spectrum telephone	\$224.95
Uniden EXP901-U 900 MHz. 1 line cordless analog telephone	\$149.95
Bogen FR3110-U Digital FAX Friday Fax-on-Demand & answering system	\$399.95
Bogen FR3020-U memory module for Fax Friday/up to 36 minutes	\$99.95
Bogen FR2000-U Digital two-line voice mail & answering machine	\$279.95
Bogen FR0018-U memory module, doubles recording time to 36 minutes	\$79.95
FANS P161P-U 60 name/number caller ID, unwanted call blocker, paging	\$149.95
SNI ID200-U Bouncer name/number caller ID, call reject, forward	\$89.95
ICOM GP22-U handheld global positioning system (GPS)	\$489.95
RELM WHS150-U VHF handheld 5 watt, 16 channel transceiver	\$299.95
RELM RH1266H-U VHF 25 watt, 16 channel synthesized transceiver	\$289.95
Ranger RC12950-U 25 watt 10 meter ham radio transceiver	\$239.95
Cobra RD1712SW-U Safety Alert & Super Wideband Laser/Radar receiver	\$139.95
Uniden LRD65995U-U Super Wideband Laser/Radar receiver-VG2 protection \$99.95	
ANTX-U VHF scanner/VHF transmitting antenna w/BNC connector	\$29.95
ANTMMBNC-U magnet mount scanner antenna w/BNC connector	\$29.95
ANTMMOT-U magnet mount scan antenna w/Motorola plug	\$29.95
ANTMPLU-U magnet mount scan antenna with PL259 connector	\$29.95
ANTSGNBC-U glass mount scanner antenna with BNC connector	\$29.95
ANTSGMOT-U glass mount scanner antenna with Motorola jack	\$29.95

Buy with confidence

It's easy to order from us. Mail orders to: Communications Electronics Inc., P.O. Box 1045, Ann Arbor, Michigan 48106 U.S.A. Add \$15.00 per radio product or weather station for U.P.S. ground shipping and handling in the continental U.S.A. unless otherwise stated. Add \$10.00 shipping for all accessories and publications. Add \$10.00 shipping per antenna. For Canada, Puerto Rico, Hawaii, Alaska, Guam, P.O. Box, or APO/FPO delivery, shipping charges are two times continental U.S. rates. Michigan residents add state sales tax. No COD's. Satisfaction guaranteed or return item in 31 days for refund, less shipping. 10% surcharge for net 10 billing to qualified accounts. All sales are subject to availability, acceptance and verification. Prices, terms and specifications are subject to change without notice. We welcome your Discover, Visa, American Express or MasterCard. Call anytime 1-800-USA-SCAN or 800-872-7226 to order toll-free. Call 313-996-8888 if outside the U.S.A. FAX anytime, dial 313-663-8888. For technical assistance, call our technical support hotline for \$2.00 per minute at 1-900-555-SCAN. Dealer and international inquiries invited. Dial 313-663-8888 for fax-on-demand info. Price schedule effective 9/1/95 AD #90195-02N Copyright © 1995 Communications Electronics Inc.

For credit card orders call 1-800-USA-SCAN

COMMUNICATIONS ELECTRONICS INC.
Emergency Operations Center
P.O. Box 1045, Ann Arbor, Michigan 48106-1045 U.S.A.
For information call 313-996-8888 or FAX 313-663-8888



All India Radio occupies several 60-meter frequencies.



La Cruz del Sur, still on 4875, is one of the older South American stations.

The 0100 sign-off also is heard in the east and central time zones during the winter. RTM uses both French and Arabic.

MONGOLIA ()** Radio Ulaan Baatar uses 4081, 4650, 4750, 4830, 4850, 4865 and 4895 from various sites but most of these almost are never heard in North America. Your best chance would be around local dawn on 4850, the most powerful of these outlets.

MOZAMBIQUE ()** Radio Mozambique usually is a pretty tough one on any band, including 60 meters. 4855 carries the external and interprovincial program, variable 4865 carries the national network and 4910 has the interprovincial network. All three sign on at 0250 in Portuguese.

MYANMAR ()** Radio Myanmar (Burma in the good old days) usually shows up quite a few times over a winter season on 4725 around local dawn.

NAMIBIA (*) Namibian Broadcasting Corp. is currently being logged on 4965 from sign-on at 0600. Programs are in English, German and Afrikaans over a 100-kW transmitter.

NEPAL ()** Radio Nepal uses 5005 with 100 kW. Try it around local dawn.

NICARAGUA (*) Still listed is Radio Rica, Managua, on 4920, although it seems to have been inactive for some time.

NIGER (*) The government station, La Voz du Sahel, operates on 5020 from 0430 sign-on in French.

NIGERIA (*) This country's radio facilities have deteriorated badly in recent years (one story has it that one of the stations was destroyed by termites!). Still active is Radio Nigeria at Kaduna, which signs on at 0430 on 4770 with English, Hausa and other local languages. Lagos on 4990 may now be inactive.

NORTH KOREA ()** Radio Pyongyang uses 4780 from 1200-1245 to East Asia. It's not often heard in North America. The Korean clandestine station, the Voice of

National Salvation, based in the North, sometimes can be heard on variable 4120, also in the morning.

PAKISTAN ()** Radio Pakistan airs a home service transmission from Islamabad on 4815 from 0045-0310 and 4915 at 0045-0215 and from Quetta on 5025 between 0045-0400. It requires highly unusual propagation conditions to hear these in North America.

PAPUA NEW GUINEA (*) NBC Port Moresby usually can be heard in the mornings on 4890. Reception of Port Moresby counts as Papua on country lists, which count this and New Guinea separately.

PERU (*) 60 meters is thick with Peruvians, many of them unlicensed stations operating with low power and sometimes erratic schedules. Licensed broadcasters Radio Atlantida, Iquitos, on 4790; Radio Cora, Lima, 4915; Radio Tropical, Tarapoto, 4935; and Radio Ancash, 4991, are the most likely to be heard, either in the evening or at their early morning sign-ons.

SURINAM ()** Radio Apinte, Paramaribo, is currently heard on 4991 until 0400 sign-off, signing on again at 0725.

RUSSIA ()** Russia always has made extensive use of 60-meter frequencies for use by transmitters serving regional audiences.

Quite a few of those are currently inactive and the status of several others is uncertain. One of the more easily heard was Petropavlovsk on 4485. If it's active, you might bag it during the early morning hours at your location.

SENEGAL (*) Radiodiffusion Television Senegalese and its 0600 sign-on used to be one of the most reliable African signals on the 60-meter band. But currently its 4890 frequency isn't in use at that hour. Try to catch the tail end of its broadcast day, which runs to 0005.

SOLOMON ISLANDS (*) Solomon

Islands Broadcasting Corp., also identifying as Radio Happy Isles, uses 5020 until 1130. Try during the summer months around 0700 or 0800.

SOUTH AFRICA (*) South African Broadcasting Corp. can be heard on 4810, carrying the Africa 2000 service from 2300-0300, then the Afrikaans Stereo service to 0600.

SRI LANKA (*)** Sri Lanka Broadcasting Corp. contributes some nigh impossible offerings on 4870, 4902, 4940 4970 and 5020, with schedules that run through our dawn hours but which, nonetheless, still are almost never reported in North America.

SWAZILAND (*) Trans World Radio's Swaziland station uses 4760 Monday through Friday for programming to East Africa. The frequency is in use only from 0300 to 0330. There's an even briefer broadcast Saturdays, from 0330-0345.

TAJIKISTAN ()** Tajik Radio, Dushambe, is on 4635 (from Yangi-Yul) between 0100 and 1900. On occasion this can be heard during our local evenings, as well as around local dawn. It's real DX, though.

THAILAND (*)** Radio Thailand has an outlet on 4830 scheduled for operation during the 1100-1300 period but, for some reason, it is rarely heard in North America.

TIBET ()** Although Tibet is part of China, some country lists (including NASWA's) count it separately. Lhasa is one of the China People's Broadcasting Station outlets on 4035 and 4750, heard occasionally at the same hours other Chinese outlets are most likely.

TOGO (*) Radiodiffusion Togolaise, also known as Radio Togo or Radio Lome, is one of the more easily heard 60-meter Africans, opening at 0500 (in French) on 5047.

TURKMEN ()** The Voice of Turkmen uses 4825 from 1200-1300 for programs

in Turkmen on Mondays, Wednesdays and Fridays. It is rarely, if ever, reported.

UGANDA ()** Reception of Radio Uganda is similar to Kenya (if one's in, the other's also likely). The 50-kW transmitter on 4976, which carries the regional service, opens at 0300. 5026 (20 kW) carries the national program and signs on at 0300.

UKRAINE ()** Radio Ukraine operates on 4820 during our evening hours (up to 0700). The channel will be blocked by Latins until 0400 or later.

UZBEKISTAN ()** Given a large dose of luck, you may be able to pick up Radio Tashkent with its domestic service on 4850 around local dawn.

VENEZUELA (*) Despite attrition through the years, there still are several "YVs" to be heard here: Radio Tachira on 4830; Radio Valera, 4840; Radio Rumbos, 4970; Ecos del Torbes, 4980, are the most reliable.

VIETNAM (*)** The several Vietnam regional 60-meter frequencies virtually never are heard by North American DXers. Check these spots around local dawn: 4000, 4500, 4762, 4767, 4800, 4820, 4880, 4960, 4965 and 5035. Most of these channels also are occupied by other Asian signals at this time.

ZAIRE ()** Radio Candip, an education-



HRVC 1380 kHz
4.82 MHz

LA VOZ EVANGELICA
Apartado 145-C
Tegucigalpa, D.C.
Honduras C.A.

La Voz Evangelica, Honduras, on 4820, is one of the most easily heard stations on 60 meters.

al station in the town of Bunia, makes for a nice catch with its 0330 sign-on on 5066. Programs are in French and local dialects.

ZAMBIA (*) Radio Zambia, Zambia National Broadcasting Corp., uses 4910 from 0245, carrying the Radio One service in English and local lingos.

ZIMBABWE (*) Zimbabwe Broadcast-

ing Corp.'s Radio Three service opens in English at 0300 on 4828 over a fairly new 100-kW transmitter.

The 60-meter band (or 4-5 MHz range) offers enough interesting listening and challenging DX to occupy you through your entire SWLing career. Why not give it a try tonight?

Call Toll Free
1-800-666-0908
Pricing and Orders Only

YAESU FRG-100
Worldwide desktop communications receiver
Covers 50kHz - 30MHz
AM/SSB/CW (FM optional)

- 50 memory channels
- Built in selectable filters 2.4, 4, 6kHz
- WRTH "Best Communications Receiver"
- Many, many more features

CALL FOR OUR LOW DISCOUNT PRICING

Yacht Boy 305 & 400	GRUNDIG World Receivers The Ultimate In Digital Technology	Satellit 700
Uniden BC9000XLT \$379.95 delivered	Optoelectronics Scout 40 ver. 3.1 \$399.95 Call for all Optoelectronics \$	AOR AR8000
Uniden BC3000XLT \$359.95 delivered UPS Ground (48 states) Call for all Uniden/Bearcat	Drake R8A and SW8 Call for discount prices on Drake, Sony, Grundig	NEW: AR8000 & Scout 40 reaction tuning MOD + cable pkg \$1039.00 Fully Warranted Free UPS Ground Shipping (48 states)
Conn Sales 203-667-9479		Infor. & Tech Help 203-666-6227

LENTINI COMMUNICATIONS, INC.
21 Garfield St. Newington, CT 06111
C.O.D.'s OK - SAME DAY SHIPPING
HOURS: M-F 10am - 6pm SAT 10am-4pm

Get A New Image

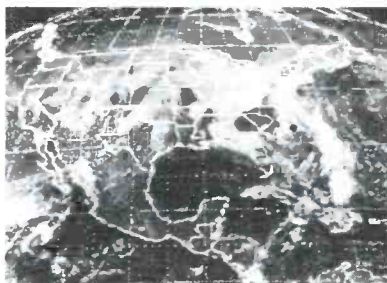

PC HF Fax Plus \$129

PC HF Fax Plus is a simple, yet comprehensive HF system that receives Fax, RTTY, CW, and AMTOR on an IBM PC or compatible. It includes an FSK demodulator, advanced signal processing software, tutorial audio cassette, and complete reference manual. Just plug the demodulator into a serial port, install the software and get text and vivid images on your PC.



PC SSTV \$149.95

PC Slow Scan Television is a complete system for sending and receiving full color amateur SSTV. The package includes an SSTV FSK modem, SSTV software, image capture utilities and reference manual. All popular formats are supported including Robot, Scottie, Martin and AVT. The system requires a 286, 386 or faster PC with VGA or super VGA display.

Have It All For Only \$199.95

For a limited time we are offering both software packages with a single FSK modem for under \$200. This combination offer will let you send and receive the popular HF image and text transmission modes.

Call or write for our free catalog. Visa and Mastercard welcomed.

Software Systems Consulting
615 S. El Camino Real, San Clemente, CA 92672
Tel.(714) 498-5784 Fax.(714) 498-0568

Tuning In On Yesterday

Let's Look at Several Forgotten Firsts

BY ALICE BRANNIGAN

We love hearing from readers who are radio historians unearthing wonderful gems. Reno's John Faulkner is one of these intrepid souls. He's a volunteer at the Nevada Historical Society, and that's where he found a rather interesting tidbit he wants to share.

John tells us that Reno's KOH, on 630 kHz, calls itself Nevada's first radio station. It's more than 67 years old, having commenced operations on Oct. 25, 1928. However, John rooted out a long-lost reference that made him ask Lou Costello's famous question, "Who's on first?"

In an issue of the *Nevada State Journal* newspaper dated April 14, 1923, there was a report about how the night before that, KDZK, the paper's radio station, put on a "joint radio program" with station KFFR, "the Sparks Radiophone in the Sparks high school."

The newspaper termed the joint program "a huge success" with radio audiences in Reno and Sparks. Reports had not yet come in from outlying towns. According to the account, the two stations kept taking turns greeting one another, exchanging signal reports and broadcasting

live music. KDZK offered selections played by the Royal String Quartet, while KFFR responded with "stirring jazz music" from Tony Pecetti and his orchestra.

A large crowd filled the Sparks school auditorium during the broadcast, though they couldn't see the performers. The broadcasters had to be sequestered in an anteroom "to deaden echoes."

The opening broadcast was from KFFR alone, going from 3:30 until 4 p.m. This consisted of announcements about the joint broadcast later in the evening. There also were musical interludes from the Sparks school orchestra. Then the station signed off.

The newspaper suggested that from 6 to 7 p.m., Reno and Sparks radio owners should continue to stay tuned to the 360-meter wavelength to listen for distant stations. They listed stations in Los Angeles, San Francisco, Salt Lake City, Denver, Dallas, St. Louis, Kansas City, Portland, Medford and Minneapolis among cities that might be heard. Then KDZK and KFFR both came on the air from 7 to 8 p.m. for their gala two-station joint broadcast.

As hokey and quaint as this may appear from a vantage point 73 years afterward, these stations nevertheless were Nevada's earliest radio broadcasters. Moreover, their novel joint program may well have never been done before in radio broadcasting!

The April 13 broadcast was not the first time KDZK had operated, according to other *Nevada State Journal* clippings John sent. The April 4 edition of the newspaper told KDZK's fans to note that it had a new time, and henceforth would present its nightly "phonograph concert" from 7 to 8 p.m. Obviously KDZK had been operating prior to April 4, 1923.

John Faulkner's news clippings confirm that these two Nevada broadcasters were on the air at least five and a half years prior to KOH opening. We checked the records and found that in 1923, KDZK and KFFR both were licensed to operate with 10 watts, though not on 833 kHz. In those carefree days, low-power stations in remote areas tended to regard their official federal frequency assignments as mere suggestions. KDZK was supposed to be on 790 kHz, per its license issued to Nevada

APRIL 14, 1923

NEVADA STATE JOURNAL

THE DRIVE GOES TO THE TOP WITH TITLE TO SPARE
Gather at Noon for Accounting Which vs \$580 Collected

JOINT RADIO PARTY PLEASING TO FANS
By "RADIO"
The joint radio program put on last night by KDZK, The Nevada State Journal's broadcasting station in Reno, and KFFR, the Sparks Radiophone in the Sparks high school, was a huge success from all reports received so far. We have not to bear from outlying towns and states but all in Reno and Sparks voted the stunt a winner. Viewed from the Sparks high school, the test was dramatic, to say the least. First you would hear Mr. Smith's voice announcing KFFR greeting KDZK and announcing the selection following by stirring jazz music played by Tony Pecetti and his orchestra, and then after a slight wait the voice of the announcer at KDZK came through on the Magnavox set saying, "KDZK broadcasting. Your music was loud and clear here. You will now be entertained by a selection played by the Royal String Quartet."
Informed in advanced by Friday's morning's Journal, a large crowd of Sparks people filled the high school auditorium adjoining the radio room. Unfortunately this crowd could not see the performers because they were hidden in a superstructure to deaden echoes, but Mr. Smith's clarion voice and Tony's superb jazz was easily heard by everybody in the room besides KDZK on the Magnavox. Those townspeople receiving sets in the two cities reported a large crowd of visitors. When I got home I found twelve kids grouped around my set and fighting over the phoner.

NATIONAL COMMANDER LEGION
Col. Alvin M. Owsley to be Guest of Local Post May 30 and June 1
Col. Alvin M. Owsley, national commander of the American Legion, will visit Reno on May 31 for a two-day stay.
Plans are afoot to accord him hearty welcome, and it is expected that Colonel Owsley may be prevailed upon to address several local meetings. News of his coming was announced yesterday by Capt. W. J. Ryan, commander of the local post.
The news from national headquarters that Colonel Owsley is to visit Reno next month is the biggest event in the history of the legion in Nevada said Captain Ryan, in announcing the visit.
"Not only is this visit of supreme interest to every World War veteran he continued, "but every citizen should be interested in hearing from the national commander who the aims and desires of the largest organization of veterans are."
While here Colonel Owsley will be the guest of Hazel Dunkle Post of the American Legion. Arrangements

CHANGE IN DIVISION

ONLY TWO LIQUOR CASES FOR GRAND JURY ACTION

Young
Our market has a lot of Dressed Hens this mor

◀ Here's the item in the *Nevada State Journal* of April 14, 1923, confirming the operation of two Nevada broadcasters. It was more than five years ahead of the station generally conceded to be the state's first station. (Courtesy John Faulkner, Nevada.)

This KOH QSL card was sent out only a month after the station went on the air in 1928. (Collection of the late Fred J. Eplin, courtesy Joseph Brewer, Hollywood, Calif.) ▼

NEWS BULLETINS FROM RENO EVENING GAZETTE

THE GATEWAY TO 100,000 SQUARE MILES OF OPPORTUNITIES

THE BIGGEST LITTLE CITY IN THE WEST

YOU'LL LIKE RENO
WHERE THE REAL WEST STILL LIVES

Mr. Fred Eplin
J. Eplin

JAY PETERS, INC. WANTS TO THANK YOU FOR YOUR REPORT ON OUR PHONOGRAPH EXTENSION TO YOU. GRAND AND EXTENSIVE VISIT OF THE NATIONAL AMERICAN LEGION

ELKS CLUB BUILDING 38 WEST FIRST STREET

JAY PETERS, INC. RENO, NEVADA

Machine and Electric Co. Inc. According to the license issued to Jim Kirk of Sparks, KFFR was authorized for 1330 kHz.

Neither station lasted very long. By 1924, KDZK no longer showed up in official Department of Commerce license listings. That year saw Sparks' KFFR licensed to the *Nevada State Journal*, but by mid-1925 it also had gone dark.

KDZK and KFFR may have been mere passing fancies. Even so, in 1923 they were fully licensed and more-or-less active broadcasters, albeit briefly. From a chronological viewpoint, that puts them ahead of KOH. When KOH went on the air late in 1928, it ran 100 watts on 1370 kHz, and was located in the Elks Club Building, 38 W. First St., Reno. It was owned by Jay Peters Inc.

Whence came KOH's claim of being first in Nevada? Our guess is because KDZK and KFFR had been low power, obscure and short-lived. In 1928, when KOH appeared, KDZK/KFFR may have either been forgotten, or else deemed too insignificant to warrant recognition.

By 1931, thriving KOH had gone up to 500 watts, and a decade later to 1 kW. For 12 years, KOH remained Nevada's only radio station. That was until Las Vegas' 250-watt KENO opened in 1940. After that, in 1946, 250-watt KBNE started in Boulder City, and 250-watt KELN in Ely was getting ready to begin. Still, KOH was Reno's only radio station for 18 years. It wasn't until 1946 that Reno got its next station, 250-watt KATO. That year also saw Reno's 1-kW KOLO begin construction. Little wonder that KOH considered itself first.

Presently, KOH still is on 630 kHz, but now runs 5 kW days, and 1 kW at night.

We like examining things such as which station deserves the title of Nevada's first station. And just think, a dozen stations claim the title of broadcasting's first radio station. But don't forget, the word "first" has more than one meaning. Ask someone to name the "first lady." The first lady is Hillary Clinton; but what about Eve? A title is a title.

Thanks to John Faulkner for locating and restoring this valuable piece of lost radio history to a heritage we all share.

A Corny Claim

On March 17, 1921, listeners around Tuscola, Ill., first heard experimental radio transmissions started by James L. Bush. He owned a local grain brokerage and hoped to use the new technology to send market information to grain elevators.

According to Becky Mabry's feature in a recent issue of the *Champaign-Urbana News-Gazette*, the 10-watt station was issued a commercial broadcasting license on April 5, 1922, for 1080 kHz with the call letters WDZ. WDZ then was being used only for sending the opening, noon and

MoItron
ELECTRONICS

310 Garfield St Suite 4
PO Box 2748
Eugene, Oregon 97402

**DTMF & ROTARY
TEST DECODERS**



TONE-MASTER™ TM-16A & TM-16A Plus

Decode and display DTMF from nearly any audio source; scanner, tape recorder, etc. And now decode and display either DTMF or Rotary digits from a telephone. **TM-16A PLUS** with RS-232 serial output includes Logger Software for optional automatic date/time/number logging using your IBM Compatible computer. Prices and specifications subject to change without notice.

TM-16A DTMF & Rotary Decoder \$179.00 TM-16A Plus with RS-232 output \$249.00

S/H: \$6 USA, \$10 Canada, \$15 Foreign. Premium shipping available for an additional charge. Visa, MasterCard, Discover & American Express Accepted. COD on Cash or Money Order basis only: \$5.

Orders: (800) 338-9058 Info: (541) 687-2118 Fax: (541) 687-2492

Imagine . . .

**A shortwave antenna so good you won't need
or want any other type of antenna system!**

With the **ALPHA DELTA Model DX-ULTRA Full Spectrum Dipole** you don't have to imagine anymore! We designed it for "knock-your-socks-off" performance with an absolutely no-compromise attitude — with full frequency access from **AM Broadcast through 30MHz!**

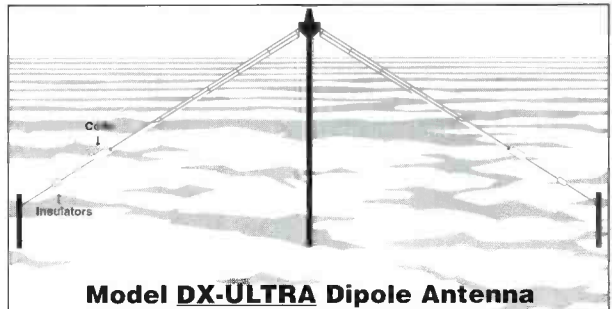

Model DX-ULTRA Dipole Antenna

- Absolutely remarkable performance for Medium Wave, Tropical, International Shortwave, Government, Military, Embassy, Maritime, Aircraft, Commercial and all other Utility communication frequency ranges.
- The DX-ULTRA design provides extremely low-noise performance for maximum sensitivity to weak DX signals.
- The wire elements' "Tapered Wing" design allows broadband operation on 1/2 wavelength and 3/4 wavelength multiples of various frequency ranges.
- The DX-ULTRA is designed with a pair of ISO-RES inductors and parallel wire elements for maximum broadband, efficient performance - no lossy narrowband traps. The difference on your S-meter can be phenomenal!
- Our exclusive Model DELTA-C Center Insulator with the built-in Model SEP ARC-PLUG® Static Electricity Protector provides effective protection for your sensitive receiver components. Connectors accept either coax or balanced line.
- Overall length of the DX-ULTRA is only 80 feet with dipole, inverted-vee, or full sloper configurations possible!
- Fully assembled - no cutting or soldering required. All components are rated for 2kW of power with all stainless-steel hardware. Can be used with a wide-range antenna tuner for commercial, military, or embassy operation.
- The DX-ULTRA is designed specifically for full spectrum shortwave performance, not just for the narrower amateur or international shortwave bands.

Alpha Delta Model DX-ULTRA, 80 ft. in length . . . \$119.95

If your space does not permit the full 80 ft. length of the DX-ULTRA, we suggest our Model DX-SWL 1/4 wave sloper (60 ft.) or our DX-SWL-S 1/4 wave sloper (40 ft.). These antennas have similar design philosophies.

At your Alpha Delta dealer or add \$5.00 for shipping and handling in the continental United States. Export orders - please call for quote.

ALPHA DELTA COMMUNICATIONS, INC.

P.O. Box 620, Manchester, KY 40962 • 606-598-2029 • FAX 606-598-4413
current solutions to current problems

**UNLOCK
FULL
800
MHz**

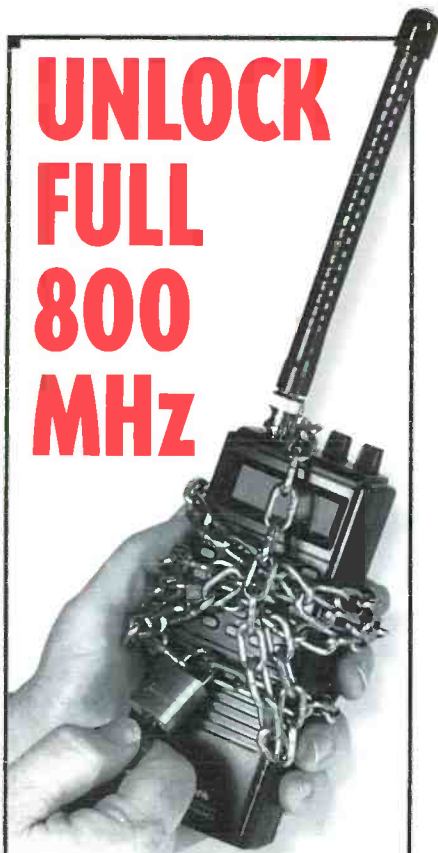

	BC
PRO	200
23	205
26	220
29	700
34	760
37	855
39	860
43	890
46	2500
51	3000
2004	8500
2005	9000
2006	ICOM
2022	R1
2026	R100
2027	R7100
2030	AOR
2032	8000

Starting at only \$40.00

Thousands of Satisfied Customers

Call for Details

508-281-8892

CELLULAR SECURITY GROUP

47 Causeway Street
Gloucester, MA 01930

W D Z
BROADCAST SERVICE
JAMES L. BUSH
*The Pioneer Radio Station for Grain
and Livestock Markets*
TUSCOLA, ILLINOIS

December 15, 1931.

Daytime Only
1070 k c
100 Watt

Write Us
For Rates
Phone 98

Mr. Joseph Leo Hueter,
172 1/2 North 18th Street,
Philadelphia, Penn.

Dear Mr. Hueter:--

We have your card of the 13th, and this letter is to verify our reception of W D Z, on December 13th at 11:-- A.M. EST., and we wish to thank you very much for the report.

The religious program was also correct.

Your report is the first of its kind received, and we think it a wonderful report and indeed very proud to receive such information. W D Z is only a 100 watt station, so you see the distance is great, as we are on daytime only.

Again thanking you for your communication,

We remain,

Sincerely yours,

W D Z BROADCAST SERVICE
By *Mrs. J. L. Bush*
Mgt.

MRS. J.L.B./R.E.H.

This 1931 W D Z veri letter to a listener in Pennsylvania is signed by Edith Bush, who managed her husband's station. The letter confirms that it's the first DX verification the daytimer ever issued. W D Z had been operating since the dawn of broadcasting! (Collection of the late Joe Hueter, in the POP'COMM archives.)



The W D Z "Kitchen Barn Dance" gang was a popular attraction during the early 1930s.

DEDICATED TO THE SCANNING AND SHORTWAVE LISTENING HOBBYIST. YOUR "ONE STOP SHOP" FOR ALL YOUR LISTENING NEEDS.

NEW!!!

RECORD-CAT Revolutionary New Scanning Tool

**ATTENTION SCANCAT OWNERS . . .
TAKE CONTROL OF YOUR TAPE
RECORDER WITH RECORD-CAT!**



A "Plug & Play" tape recorder controller interface, RECORD-CAT plugs into your printer port & tape recorder remote jack. Using SCANCAT, RECORD-CAT permits fully programmable recording by receive frequency!

(SCANCAT GOLD required.) **RECORD-CAT \$29.95** (plus \$5.00 S&H)

CAT-WHISKER

**TIRED OF YOUR HANDHELD SCANNER
ALWAYS FALLING OVER JUST
TO KEEP THE ANTENNA "VERTICAL!"**



Try our unique, swivel base, telescopic scanner antenna. Our new CAT-WHISKER lets you lay your handheld scanner on its back and still keep the antenna vertical!

- Swivels to ANY angle
- Easily adjusts to any length AND frequency
- Fits ANY scanner with a BNC antenna connector
- Fits on BACK or TOP mount scanner antenna inputs

**What other antenna will let you lay your handheld
on a car seat and still receive?**

CAT-WHISKER #1 (5 to 23 inches).....**\$19.95**
CAT-WHISKER #2 (6 to 36 inches).....**\$24.95**
(plus \$2.50 S & H)

**WE CARRY INTERFACES FOR ICOM &
AOR AR8000 IN STOCK,
INCLUDING OUR "UNI-VERSATILE"
INTERFACE - \$99.95**

NEW!

COPYCAT-PRO

IMPROVED!

**The ONLY Commercially Available
Computer Control Program
for the Universal M-7000 & M-8000,
AEA's PK-232 and the MFJ-1278 . . .
... JUST GOT BETTER!**



STANDARD COPYCAT FEATURES

- 32K incoming text buffer
- Pull down menus
- Mouse support (but not required)
- 20+ programmable macros
- Runs on any 640K PC Compatible
- 50 page printed manual
- New improved online help
- Note: Std. COPYCAT Does Not Support Radio Interface

NEW COPYCAT-PRO FEATURES

- Control BOTH your TNC and radio simultaneously! Send commands to TNC and at same time, send frequency and mode to radio!
- NEW! Multiple pop-up windows for HELP, frequency files, and text editor. Instantly go between any of three windows with single keystrokes.
- Supports ALL SCANCAT frequency file formats, or create your own!
- NEW, easier, "Plain English" MACRO language for control of all radio and TNC functions.
- RADIO SUPPORT for most AOR, KENWOOD, JRC, ICOM, YAESU, plus LOWE's HF-150 and Watkins Johnson's HF-1000.

Discover our revolutionary COMPUTER CONTROL PROGRAM for the M-7000 and M-8000, Let COPYCAT free you FOREVER from remembering all those buttons and keys. COPYCAT does it all! Simple "PULL-DOWN" menus control all functions. No more looking through complicated manuals or searching for buttons. ALL commands are in plain English. "PLUS" COPYCAT has a fully editable text buffer, with cut & paste. Save/load/edit/print files. PROGRAMMABLE macros and much more. COPYCAT supports ALL the above units within ONE program. Simply select your units from COPYCAT's EASY-TO-USE menu and GO!

COPYCAT-PRO \$79.95, COPYCAT (std) \$59.95

upgrades to COPYCAT-PRO \$24.95 S/H \$5.00 (\$7.50 Foreign)
(If you don't have the specially wired cable for the M-7000/8000, be sure to order our serial adapter (\$24.95))

SCANCAT GOLD

Windows 95 &
Pentium Compatible

Since 1989, The Recognized Leader in Computer Control

**Once you use SCANCAT with YOUR radio, you'll NEVER
use your radio again WITHOUT SCANCAT!**



SCANCAT supports most radios by:
AOR, DRAKE, KENWOOD, ICOM, YAESU and JRC (NRD)
Plus PRO-2005.6 & 2035/OS456, Lowe HF-150, and Watkins-Johnson HF-1000

- Search between any 2 frequencies.
- Search by ANY increment.
- Create Disk files.

SCANCAT 6.0 FEATURES

- Import from most text formats to a working SCANCAT file.
- Log found frequencies to files while scanning.
- Scan Disk Files Frequencies.
- Spectrum Analysis to Screen OR Printer.

SCANCAT - GOLD FEATURES

We simply don't have the space to tell you ALL the new GOLD features

SCANCAT-GOLD includes ALL ABOVE 6.0 FEATURES PLUS

- Link up to 15 frequency disk files.
- D-BASE IMPORT including Spectrum CD.
- Scan HF & VHF Icom's simultaneously.
- PRINT to ANY printer, or Disk File.
- Automatic BIRDIE LOCKOUT.
- Link up to 15 search banks.
- IMPORT virtually any database.
- Search by CTCSS & DCS TONES with PRO2005, 6/2035 (& ICOM/DC440).
- MULTIPLE search filters.

PLUS - POWERFUL COMMERCIAL FEATURES SUCH AS:

- Demographic search for frequency co-ordination and 2-way Usage Analysis.
- Detailed logging to ASCII type files with DATE, TIME, Sig Str, Air Time
- UNLIMITED file sizes with our exclusive SCANCAT filing method.
- Exclusive "MACRO" control by frequency of Dwell, Hang, Resume, Sig. Threshold and even 6 separate programmable, audible alarms.
- Command line options for TIMED ON/OFF (Unattended) logging/searches.

***SCANCAT IS NOT COPY PROTECTED - USE ON AS MANY COMPUTERS AS YOU NEED *
SCANCAT will run on virtually ANY 640K computer, EVEN HP-100XLT PALMTOP!**

SCANCAT comes ready to run ALL supports radios within only ONE program. SCANCAT makes your listening hobby a breeze! Plus, the included SCANPORT allows you to convert your favorite BBS, D Base or Text Files to a running SCANCAT file: 100+ Page manual included. Requires a 640K MS-DOS computer w/RS-232C serial port - hard disk recommended. Manufacturer's Interface not included. CALL or WRITE for FREE information or our \$5.00 FULLY OPERATIONAL DEMO DISK (includes shipping/handling). ORDER NOW & RECEIVE as a BONUS, FOUR SCANCAT FREQUENCY FILES!

SCANCAT GOLD**\$94.95**
SCANCAT 6.0**\$69.95**
UPGRADE to GOLD from any version**\$24.95**
SQUELCH DETECT CABLES**\$24.95**

**Fully Restorable
AR8000
with SCANCAT GOLD
This Unit is
FULLY RESTORABLE**

**Now
Supports
Opto Scout**

**Now!
Supports
Lowe
HF-250**

**NOW
AVAILABLE!
PerCon Spectrum
CD-ROM
\$29.95**

**PLUS \$5.00 S & H
\$7.50 FOREIGN**

HOKA CODE-3 USA Version

**FINALLY - NOW AVAILABLE IN THE USA
"The Standard Against Which All Future Decoders Will Be Compared"**

Many radio amateurs and SWLs are puzzled! Just what are all those strange signals you can hear but not identify on the Short Wave Bands? A few of them such as CW, RTTY, Packet and Amtor you'll know - but what about the many other signals?

There are some well known CW/RTTY Decoders but then there is CODE-3. It's up to you to make the choice, but it will be easy once you see CODE-3. CODE-3 has an exclusive auto-classification module that tells YOU what you're listening to AND automatically sets you up to start decoding. No other decoder can do this on ALL the modes listed below - and most more expensive decoders have no means of identifying ANY received signals! Why spend more money for other decoders with FEWER features? CODE-3 works on any IBM-compatible computer with MS-DOS with at least 640K of RAM, and a CGA monitor. CODE-3 includes software, a complete audio to digital FSK converter with built-in 115V ac power supply, and a RS-232 cable, ready to use.

CODE-3 is the most sophisticated decoder available for ANY amount of money, and the best news of all, is that it is available from a United States dealer.

26 Modes Included in STANDARD package include:

- Morse
- RTTY/Baudot/Murray
- Sitor CQIR 625/476-4
- ARO - Navtex
- AX25 Packet
- Facsimile all RPM (up to 16 gray shades at 1024 x 768 pixels)
- Autospel - Mk's I and II
- DUP-ARQ Artrac
- Twimplex
- ASCII
- ARQ6-90/98
- SI-ARQ/ARO-S
- SWE-ARO-ARO-SWE
- ARO-E/ARO1000 Duplex
- ARO-N-ARQ1000 Duplex
- Variant
- ARQ-E3-CCIR519
- Variant
- POL-ARQ 100 Baud Duplex ARQ
- TDM242/ARQ-M2/4-242
- TDM342/ARQ-M2/4
- FEC-A FEC100A/FEC101
- FEC-S + FEC1000 Simplex
- Sports info 300 baud ASCII
- Hellscriber-Synch/Asynch
- Sitor • RAW (Normal Sitor but without Synch.
- ARQ6-70
- Baudot F788N
- Pactor
- WEFAX

- All modes in typical baud rates with possibility of changing to any desired value of speed and shift.
- All options are available from the main menu, saving or loading to and from hard/floppy drive in bit form, means no loss of unknown signals!

- HURRY! For a limited time the Standard CODE-3 package includes FOUR options:
1. OSCILLOSCOPE 2. ASCII STORAGE 6. AUTO CLASSIFY 7. PACTOR

STANDARD CODE-3 PACKAGE \$595.00 ALL FOUR EXTRA OPTIONS - \$199.95

NOW AVAILABLE - CODE-30 DSP-Based Decoder with all above options. SCALL (318) 687-2555

(SHIPPING & HANDLING \$10.00) DEMO (SLIDE) DISK ONLY \$5.00

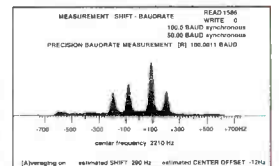

Simulated Speed Measurement Module

EXTRA OPTIONS

- Option 3 Piccolo\$85.00
- Option 4 Coquelet\$85.00
- Option 5 4 special ARO & FEC systems TORG-10/11, ROU-FEC/RUM-FEC, HC-ARQ (ICRO) and HNG-FEC\$115.00
- Option 8 SYNOP decoder... \$85.00

INTERNET WEB ADDRESS - <http://www.bccr.secret.com/scancat.html> WEB E-MAIL - scancat@bccr.secret.com

**DEALER
INQUIRIES
INVITED**

**FREE DEMO ON
BBS & WWW**

COMPUTER AIDED TECHNOLOGIES

P.O. Box 18285 Shreveport, LA 71138

Orders Only (318) 636-1234 FAX (318) 686-0449 (24 hrs) Live Tech Support (318) 687-2555 (9 a.m. - 1 p.m. Central M-F)

Nitetime BBS (SCANCAT File Area) (318) 631-3082 (7 p.m. - 6 a.m. Central),

Order direct or
contact your
favorite dealer



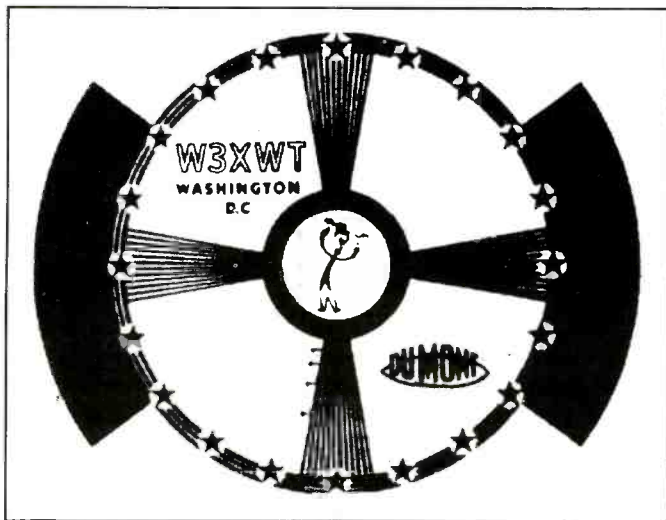

Original DuMont 1945 TV test pattern for experimental W3XWT, which soon became WTTG in Washington, D.C. WTTG now operates as Fox's Channel 5.



Hi there! How about that reader who thought I was camera shy?

closing market reports.

It occurred to Bush that radio was attracting a lot of public attention, so he swung into action. He became the local distributor for Westinghouse and RCA receivers, then he had WDZ play recorded music in the periods between market reports that otherwise had been dead air time. This was a good idea.

The studio was located in The Star Store Building, 101-1/2 N. Main St., Tuscola. It was on the second story of a building that's the present location of The Pharmacy. After WDZ moved out, the second story burned. The transmitter was at the intersection of U.S. Highways 36 and 45.

By 1929 (on its new frequency of 1070 kHz), WDZ had attracted a large enough audience to begin programming live talent. Calling itself "The Buckle of the Corn Belt," WDZ was a magnet for amateur rural entertainers from throughout Kentucky, Tennessee and southern Illinois. WDZ then was a 100-watt daytime station. Edith Bush, James' wife, managed the entire operation.

WDZ claimed to be the nation's pioneer grain and livestock market station. Those who weren't interested in market information could pass the hours listening to WDZ's pleasurable blend of farm news, hometown gossip, cornball humor, and what then was popularly called "hillbilly music."

Tuscola listeners tuned in the big Chicago stations to hear network programs, but for many years WDZ was the only commercial radio station in their local area. Everywhere the WDZ signal could be heard, it was welcomed as a friendly neighbor, and loved by all. WDZ was an original. It laid the groundwork for rural, farm-oriented radio in the Midwest.

Exposure over WDZ made stars out of many of its amateur talent discoveries. One of these was "Smiley" Burnette, who later

became Gene Autry's movie sidekick. Becky Mabry relates how Burnette was delivering furniture to the Bush home when he casually mentioned that he could play the accordion. Next thing he knew, he was urgently summoned to perform over WDZ when the harmonica player failed to appear at air time for his sponsored program. As they say, the rest is history.

WDZ's air personalities toured the Midwest doing concerts and signing autographs. The station received 9,000 letters a week from fans of their entertainers.

Despite the poor national economy, WDZ was successful enough in 1937 to increase its power to 1 kW, requiring a shift of frequency to 1050 kHz. In the mid-1930s, the Bush family sold controlling interest to Edgar Bill of Peoria, Ill.

Times were changing. In 1945, WDZ ended its market reports. The next big change occurred in 1949, when the owners relocated the station to Decatur, Ill. It has been there ever since, experiencing several ownership changes.

In 1962, when WDZ was owned by Mid-States Broadcasting, the licensee applied to increase power to 5 kW. The request did not receive FCC approval.

Today, WDZ still operates with 1 kW on 1050 kHz, but presently runs an adult contemporary music format. Since 1964, WDZ has been owned by Prairieland Broadcasters Inc.

WDZ's grain market prices are long gone, along with the hillbilly music and corny rural humor. Older Tuscola residents still fondly remember when WDZ was there, and how it inspired many other broadcasters throughout the Midwest.

Our appreciation to John File, KG9AG, of Tolono, Ill., for sending along a copy of Becky Mabry's feature. In preparing the foregoing, we combined some of the infor-

mation from that piece with material from our own archives.

Modest Beginnings

Television station WTTG, Channel 5, in Washington, D.C., celebrates its 51st birthday in May, which means it's a certified pioneer. According to Patricia Brennan's story about WTTG that appeared in *The Washington Post's* TV magazine, the station got off to a tenuous start.

During the last days of World War II, the station's transmitter and other components were driven from New Jersey to Washington by engineer Thomas G. Goldsmith Jr. and three associates. They managed to transfer all of the equipment to a room on the 12th floor of the Harrington Hotel, then employed unused elevator cables to feed power up to the equipment from the hotel's basement.

On May 19, 1945, the FCC issued the construction permit. Only nine days later, an experimental license was issued because station W3XWT was ready to begin telecasting. This station was being put on the air under the auspices of Allen B. DuMont Laboratories of Passaic, N.J., where Goldsmith was the director of research.

DuMont Labs manufactured expensive upscale TV receivers. Because there were few TV stations in operation, DuMont was anxious to get more stations on the air in order to spur receiver sales. Goldsmith had previously put DuMont's New York station on the air (WABD, Channel 5), and Pittsburgh was scheduled after Washington was up and running.

DuMont's New York station had a few hours per week of local programming. That didn't help W3XWT, which hadn't gotten around to doing more than getting a signal on the air. The station ran a test pattern,

and a repeating audio message asking viewers to call the station at the hotel. It took three months before they got any response, and that was in August when the war in the Pacific ended.

That day, crowds of celebrating people were surging through the streets. Goldsmith, therefore, decided to take his pen and write "War Is Over" across a blank video slide. That's when the Navy called the station. They had been monitoring the radio spectrum for clandestine activity, and became curious about the signals. This was the station's first "program," and its first viewer reaction! Certainly this must be the most inauspicious beginning ever to a 50-year career in television broadcasting.

In November 1946, the FCC licensed W3XWT as commercial station WTTG. The call letters incorporated Thomas T. Goldsmith's initials. Washington, New York and Pittsburgh eventually became the nucleus of the DuMont Network. DuMont later sold an interest in the network to Paramount Pictures. This proved counterproductive and resulted in programming cutbacks, forced the sale of the profitable Pittsburgh station, as well as creating FCC inquiries.

DuMont changed its name to Metropolitan Broadcasting in 1958, and by 1959 Paramount was bought out by John Kluge. The company then became known as Metromedia Inc. Fox Television purchased Metromedia in 1986.

This excellent information about W3XWT/WTTG was sent in by Brian Bohall, Leesburg, Va.

Museum News

The Museum of Television and Radio in New York City has done excellent work restoring historic broadcast programming. They have an extensive library of old radio and TV broadcasts that the public can use for research or enjoyment. They have been somewhat low-key, but now have a World Wide Web site on the Internet (<http://www.mtr.org>) as their online calling card. Thought you'd like to know.

Thanks to readers who send us tapes of air checks and programs. They are wonderful, and I have written directly to those who have sent them in. One great air check was big band music by Larry Clinton, Hal Kemp and Henry Jerome. You know, "From high atop the Grand View Hotel, in beautiful Lake Placid, N.Y., dance to the music of Larry Clinton and his Orchestra." My kind of tunes.

Please pass along any old time radio or wireless QSLs (originals or good copies), station lists, anecdotes, memories, news clippings, station photos, picture postcards, ideas or questions. It's all appreciated, and used in the preparation of this column. Let's meet here again next month on the road to Radioville. ■

How I Got Started

Popular Communications invites readers to submit in about 150 words how they got started in the communications hobby. They preferably should be typewritten, or otherwise easily readable. If possible, your photo should be included.

Each month we will select one entry and publish it here. You need submit your entry only once; we'll keep it on file. All submissions become the property of *Popular Communications*, and none can be acknowledged or returned. Entries will be selected for use taking into consideration if the story they relate is especially interesting, unusual, or even humorous. We reserve the right to edit all material for length and grammar, and to improve style.

The person whose entry is selected will receive a one-year gift subscription (or one-year subscription extension) to *Popular Communications*.

Address all entries to: How I Got Started, *Popular Communications*, 76 North Broadway, Hicksville, New York 11801-2909, or e-mail to POPCOMM@aol.com.

Our March Winner

This month our winner writes in from the Cornhusker State. Meet Steve Larison from Holdrege, Neb.:

"I began listening to shortwave and DXing AM as a child. My father, also an SWL, collected QSL cards from all over the world and mounted them in an album. I loved looking at them, imagining what life was like in those countries. He used to receive a newspaper from Radio Free Europe; I learned about the Iron Curtain looking through those RFE newspapers.

"I remember driving my mother nuts when the old Philco made those strange noises. When I finally did find a station with a foreign voice speaking, I thought it sounded so exotic. I learned a lot by fumbling around with the dial, and discovering a new country every now and then.

"With the advent of digital tuning, I enjoy the hobby a lot more now. It is so much easier to tune where I want to listen right away, but there remains a special pleasure in tuning on one of the old analogs as you never know what you'll come up with!" ■



Steve Larison and the radios that allow him to explore new worlds.

Books You'll Like

BY R.L. SLATTERY

The Written Word

Warren R. Freeman has put together an informative book about how to transfer existing technical expertise into manuscripts. He notes this ability could open up career possibilities or advancements, thereby providing increased earning power.

Freeman's 168-page illustrated book is a well-done treatise on how to work up acceptable technical manuscripts that could be suitable for use as military, aerospace or commercial manuals or engineering documents.

In his book, *Technical Writing for Technicians*, there is information that explains virtually everything, including deadlines, outlines, depth of complexity, style, preferred words and phrases, punctuation, charts, tables, illustrations and drafts.

Technical Writing for Technicians

**How to Build a Career as a
Hardware Technical Writer**

WARREN R. FREEMAN

The reference material culminates in an excellent sample tech manual, as the reader ultimately is put to the test of creating such a document. By the time this portion of the book is reached, undoubtedly a reader who paid attention shouldn't have any trouble fulfilling the author's premise, using their existing technical knowledge to move up to technical writing.

Freeman knows his topic and does a fine job explaining technical manuscript preparation from start to finish. This apparently was everything the book set out to do. We wish it went further with pointers, leads and ideas for shifting tech writing careers into first gear. Instead, Freeman states, "knowledge of this information cannot

guarantee a position as a technical writer."

Obviously, the author can't guarantee work. A bit of enthusiasm about employment prospects would have helped, though. Even if tech writing ability isn't a guaranteed meal ticket, at the very least it's a worthwhile and practical accomplishment to enhance professional skills. With today's falling military and aerospace budgets, it would be a good idea to investigate employment opportunities before quitting a day job on the basis of having acquired this ability.

Technical Writing for Technicians is \$19.95 from Contemmax Publishers, 17815 24th Ave. N., Plymouth, MN 55447; phone (612) 473-6436.

Ipsa Crypto

According to a recent survey of 320 companies, 39 percent connected to the Internet have no firewall security; 20 percent have experienced some type of break-in during the past year; and 83 percent give e-mail access to all employees.

Misuse of the Internet is rampant. That's put personal information; business data; insurance, school, legal and medical records; and banking and other financial information at the fingertips of determined vandals who can freely change, steal, vandalize or destroy files.

In the 784-page second edition of *Applied Cryptography: Protocols, Algorithms and SourceCode in C*, Bruce Schneier presents practical information on using the latest protocols and algorithms to implement a variety of impenetrable encryptions. Here's the book that explains

the U.S. government's Clipper Chip and other potential encryption standards. There are new encryption algorithms obtained from Russia, South Africa and many other nations. You'll find the latest encryption techniques for emerging digital signature and digital cash technologies. There are innovative techniques for designing and managing encryption algorithms.

Protecting data turns out to be one of the most formidable challenges in the digital world. *Applied Cryptography* is not merely a general book on encryption techniques, it was created with the intention of being a definitive data security guide for computer programmers.

Applied Cryptography, Second Edition, is \$49.95 in its softcover edition (\$69.95 in hardcover) from John Wiley and Sons Inc., 605 Third Ave., New York, NY 10158; phone (212) 850-6630. In Canada, it may be convenient to order from the publisher's Ontario office at (416) 236-4433.

Dial-A-Smile

Despite being repeatedly reminded, members of the public don't understand that virtually all cordless, cellular, ship-to-shore and air-ground phone calls can easily be monitored by anyone with a scanner. Therefore, people think nobody else is listening in as they express their innermost feelings, argue, lie, cry, gripe, conduct financial transactions, discuss lurid family problems, spread rumors, ridicule neighbors, cheat on spouses, make deals and engage in criminal activity.

In actuality, there are tens of thousands of avid listeners who enjoy tuning the scanner and HF shortwave bands searching out their conversations. This all occurs regardless of laws forbidding the public to listen! If anything, such laws have only heightened curiosity. Recreational eavesdroppers know the animated conversations often are X-rated, sometimes hilarious, and always better than TV. It's all real, all day, every day and without commercial breaks.

Tom Kneitel's *Tune In On Telephone Calls!*, is the original book about recreational eavesdropping on cellular, cordless and other phone calls made from cars, portables, homes, offices, aircraft, trains and boats. The best seller has repeatedly turned up on TV and in newspaper stories.

Now, Kneitel's controversial 160-page illustrated guide is available in its newly updated third edition, complete with a re-

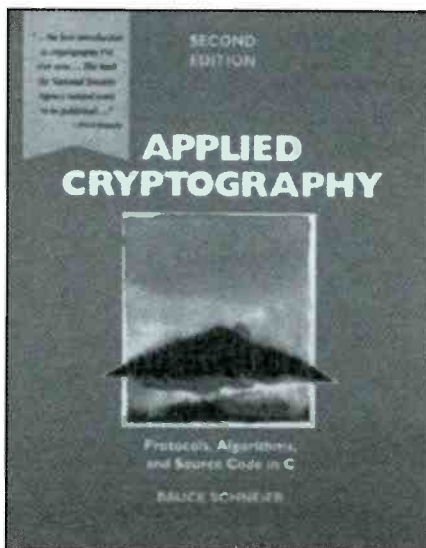

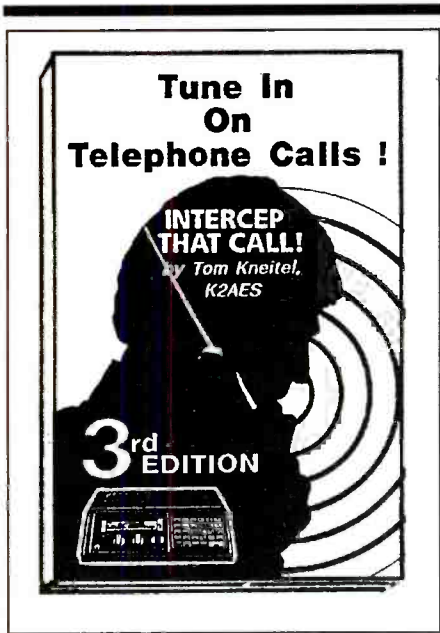

designed cover. Inside is newly added information, such as specific 900-MHz cordless phone channels and the new 46-/49-MHz cordless channels. More radio paging frequencies are provided, as well as new info on air-ground phone monitoring.

There's information on specialized accessories used to increase the scope and enjoyment of recreational eavesdropping. For instance, DTMF tone decoders can display the digits callers enter using phone pushbuttons. Those include numbers being dialed, as well as credit card, bank account, loan, remote answering machine, voice mail control and other numbers.

The book also tells of specialized 46- and 800-MHz band eavesdropping antennas. Also mentioned is the scanner accessory for monitoring non-voice digital alphanumeric beeper paging traffic. These transmissions contain many business and often spicy personal text messages.

This is the updated 1996 edition of the original source of all necessary vital information, techniques, frequencies, stations, legalities and opinions relating to recreational eavesdropping. According to the national media, it is a hobby that continues to grow. Here's the one reference candidly explaining what all the fuss is about, and how folks are listening in from coast to coast.

Tune In On Telephone Calls!, Third Edition, is available from many leading communications dealers. It also may be ordered for \$16.95, plus \$5 shipping and handling (\$6 to Canada). Residents of New York state should add \$1.81 tax. Order from CRB Research Books Inc., P.O. Box 56, Commack, NY 11725-0056. VISA/MC accepted. Phone orders: (800) 656-0056; Canadian orders: (516) 543-9169.

We Have Scanners with 800MHz Coverage!

ICOM R9000, R7100, R1, R100
Yupiteru MVT-7100, MVT-8000
AOR AR-2700, AR-8000A, AR-3000A
We do Modifications for your Scout!

AR-8000 Wide Range Receiver

500KHz~1900MHz coverage AM/NFM/WFM/USB/LSB/CW
1000 Memory Channels (50 x 20) • Computer Interface
Ferrite Rod Antenna for below 2MHz • Selectable Step Size



ATLANTIC HAM RADIO Ltd.

(416) 636-3636 368 Wilson Ave
(416) 631-0747 fax Downsview, ON
All U.S. Orders Shipped UPS Air Canada M3H 1S9

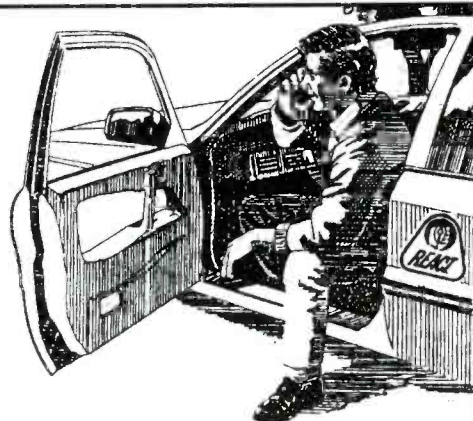

When
seconds
count,
REACT® needs you...

...to summon help for an injured motorists, an elderly woman trapped in a fire, a trucker stranded in a blizzard, a drowning child!

As a REACT volunteer CB radio monitor you may be the only communications life-line for someone in serious trouble. You relay messages from those desperate for help to police or other emergency services.

Your REACT Team will also use CB and other radio services to provide safety communications for events like parades, marathons and even balloon races. The fellowship with other REACT members at Team meetings and annual conventions is an added bonus.

Volunteer. Join Today!

**Add a New, Exciting
Challenge to Your Life.
Help Save Lives
and Property!**

REACT® International, Inc.

Tel (316) 263-2100
FAX (316) 263-2118
P.O. Box 998, Wichita, KS 67201



Checked Out

BY W.W. SMITH

POP'COMM REVIEWS PRODUCTS OF INTEREST

MFJ-8100 World Band Receiver

I think I reached my frustration tolerance with modern radio equipment when I first saw a friend's new 2-meter mobile rig. This particular transceiver had something on the order of 30 control functions built into the microphone case. All those tiny buttons must have given the design ergonomacist nightmares for a year.

Watching my buddy try to maneuver his car and manage his newest toy was an exercise in both humor and terror for me as a passenger. Certainly it made me long for simpler days. After kissing the ground when my pal dropped me off, I decided to see whether uncomplicated radio listening still could be found in this day and age when bells and whistles rule. This exercise in radio regression lead me back to the world of radio regeneration.

The MFJ-8100 is a giant step backward to the early days of radio listening. The basic concepts behind this receiver design have their roots in the very beginnings of radio although the engineers at MFJ have taken full advantage of modern componentry to get the job done. This provides a design that is both inexpensive and can—with some practice—produce excellent results for any listener.

Regenerative receivers hold an interesting place in radio history. They were the essential improvement over simple crystal detectors that made radio practical for most people in those early days of the medium. To some degree, the design was overshadowed by the "superheterodyne" circuit. Still, simple, inexpensive regenerative receivers remained popular with hobbyists and experimenters well into the 1960s. MFJ revives this design for a new generation and it remains as much fun to use as it must have been for people in the early days of radio.

Build It Yourself

Available as either a kit or in its fully wired-and-tested form, the MFJ-8100 gives you the option of building your own shortwave receiver. The design consists of less than 50 parts and components and can be easily assembled in an evening or two by anyone with basic skills in soldering and assembly techniques. The instruction manual is informative and the majority of the components mount on a single, well-



The MFJ-8100 World Band Receiver can take you back to the days of past receivers.

marked printed circuit board. This is a far cry from the "wood and fahnestock clip" construction techniques of the early days of radio. Also, this receiver comes with a sturdy all-metal case, cover and front panel, which is more than can be said for many modern receivers.

If you run into trouble with either construction or use, MFJ offers technical help by way of an 800 number. I didn't find a need to give the line a call during this project, but I did feel good knowing that it was there if I needed it.

If you are new to the radio hobby, you can learn a great deal about how receivers work by digging in and building this simple circuit. The most basic concepts of radio receiver design that you will encounter during this project will serve as a great foundation of knowledge for further receiver purchases. If you have been around the hobby for a few years or if you are an old-timer who remembers the joys of earlier regenerative receiver designs, you may want to use the MFJ-8100 as bait to get a child or grandchild unglued from the television set. There is a lot of fun packed into building and using this basic receiver.

What Bands?

The receiver tunes the major portions of the shortwave spectrum in five bands. Range A covers 3.5 to 4.3 MHz. Most evenings this band will let the user listen in to 80-meter amateur radio communications in both the CW and SSB modes. You

also should be able to catch shortwave broadcasters in the 90- and 75-meter bands. Range B covers 5.85 to 7.4 MHz. Throughout the afternoon and evening, this range will produce dozens of strong shortwave broadcasts in the 49-meter band. This also covers the currently popular "pirate radio" frequency of 6955 kHz. You also will be able to tune up through many utility maritime and aircraft frequencies into the 40-meter ham band and the 41-meter shortwave broadcast band.

Range C covers 9.5 to 12 MHz. This covers the very active 31-meter shortwave broadcast band, WWV at 10 MHz and the 30-meter ham band as well as some military and utility activity. Range D covers 13.2 to 16.4 MHz. This gives you access to the 20-meter ham band, which often is very active as well as the 21-meter shortwave broadcast band. It further takes you through many utility frequencies, including the 15-MHz signal for WWV and on into the 19-meter shortwave broadcast band. Range E covers 17.5 to 22 MHz, which covers the 16-meter shortwave broadcast band, the 17-meter ham bands, WWV on 20 MHz and the 15-meter ham band. These five frequency ranges are on par with many analog portable receivers currently being produced with additional coverage of many amateur radio frequency ranges left out by these other receivers. Regardless of the time of day, you certainly won't want for signals to add to your log.

Panel layout is the epitome of simplicity: five-position bandswitch, main tuning

What Is Regeneration?

The regenerative receiver circuit was developed by radio pioneer Edwin Armstrong. It represented a significant improvement over crystal or diode detectors by allowing a feedback process to occur. By making it possible for the detector circuit to feed back a portion of its signal repeatedly into the input in a controlled fashion, weak signals are boosted to readable levels. This design allowed early radio hobbyists to hear stations that would have been impossible with previous technology.

Further, it was the early regenerative receiver design that made shortwave listening and what we know now as amateur radio possible. Its tremendous gain and selectivity at very low cost made long-distance radio listening a hobby almost anyone could enjoy.

Edwin Armstrong would go on to invent the superheterodyne circuit as well as develop practical applications for frequency modulation (FM).

MFJ-8100 World Band Receiver

Kit price: \$59.96

Wired-and-tested price: \$79.95

Available from: MFJ Enterprises Inc., P.O. Box 494, Mississippi State, MS 39762, phone (800) 647-1800.

control, regeneration control, power switch and volume control. That's a far cry from my comrade's multiple-control 2-meter unit. The receiver is powered by a standard 9-volt alkaline battery and the circuit design includes an LED power light to prevent you from forgetting to turn off the receiver when not in use. Still, current consumption of this design is very low and you should get hours of listening out of one battery in keeping with the overall low-cost nature of this project.

Up And Running

Setting up the unit for use also is a simple process. All you need to add to the project is the above-mentioned 9-volt battery, any inexpensive "personal stereo" headphones you happen to have around your house, a simple longwire antenna and a connection to a good earth ground. Most of my listening was conducted using a 40-foot outside longwire antenna, but good results also were obtained with as little as 10 feet of wire strung indoors. An interesting feature of this receiver is its dual headphone jacks. This allows you to share

in the listening experience with someone else making it the perfect receiver for teaching a newcomer about shortwave broadcast or amateur radio.

Once I was set up, I found many of my old friends on the air. BBC, Deutsche Welle, Radio Canada International, Voice of Russia, Voice of America and Radio Netherlands all were there, as were dozens of other signals.

The hardest thing for most folks to get used to when using a regenerative receiver is the "two-fisted" nature of the tuning process. Once you locate a signal, you then must adjust the regeneration control for best listening. Not providing enough regeneration leaves the signal unreadable. Feeding in too much regeneration will result in oscillation, which produces a whistling sound in your headphones. At first, the whistling is a bit of an annoyance, but as you begin to develop your touch with the regeneration control, those whistles become just another tuning tool. You simply adjust them away and get on with the business of logging the stations.

Once you've got the hang of tuning in standard AM shortwave broadcast signals, the next challenge is to turn your regenerative tuning skills to listening in on CW and SSB signals. When listening to CW signals, the regeneration control behaves much like a fine tuning control. You can use it to adjust the CW note to a comfortable tone and copy away. SSB tuning is similar, you adjust the tuning control slightly above or below the signal (depending on if it is USB or LSB) and then fine tune the "duck" sound into a human voice by way of the regeneration control.

Like flying and stout ale, regenerative tuning is a learned experience. But with mastery of the skill comes a great deal of satisfaction and fun. It is a totally different experience from the modern world of push-button tuning augmented by a digital readout. With this receiver, you will have to go back to the days of hunting for your signals. In the process of looking for your favorites, you will be sure to turn up many things you never would have heard otherwise. You also will develop listening skills that will improve your abilities when you turn your attention to more feature-laden receivers.

What's It All About?

OK, so what sets this design apart from your grandfather's "Genny"? Well for starters, you will not be able to enjoy the warm glow of that old 200-series triode tube that was the centerpiece of so many fine old receivers. The classic glass vacuum tube is replaced with a pair of modern field-effect transistors (FETs). Another FET serves as an RF amplifier that helps to dig out many weaker signals that an older

regenerative design might miss completely. Further, the use of an RF stage helps to reduce RFI coming back through the antenna. Also, reasonable audio for the headphones is provided by way of an LM386 integrated circuit amplifier.

These modern components provide a level of stability and overall performance that Grandpa would have sold the farm for. This stability eliminates much of the difficulty associated with regenerative tuning. Tuning is further augmented by the excellent vernier reduction drive on the main tuning control. This feature smoothes out the tuning to make adjustment of the regeneration less twitchy as you span the shortwave spectrum in search of signals. The engineers at MFJ have updated the regeneration control circuit to allow for smooth adjustment that can be tuned up to the point of oscillation without the annoying popping sounds that old-fashioned regen circuits were famous (or infamous) for.

Ham Companion

An intriguing possibility for this receiver is low-budget amateur radio. It would not be too difficult to use this receiver in conjunction with a simple "junk box" QRP CW transmitter circuit. Such a ham station would be both challenging and rewarding to use.

Essentially, you would be taking yourself back to the days when all radio was amateur radio. I found the receiver's performance in the CW portions of the 80-, 40-, 30-, 20-, 17- and 15-meter bands to be sufficient for good single signal copy, again, with careful adjustment. I've used this receiver on several nights to copy the CW bulletins off W1AW. It made me feel like a real "old-timer."

If you're the kind of person who can't leave things alone, the receiver's large case and well-thought-out circuit design lends itself to any one of several modifications. For example, it would not be too difficult to add a simple audio amplifier and speaker to the case to allow listening without the need for headphones. Also, several alternative power resources could be considered. The receiver's low power consumption might make for some interesting experiments with solar power.

All too often, the high price of radio hobby equipment forces us to take things far too seriously. The MFJ-8100's low cost, simple design and relatively easy-to-use control system brings back a lot of fun to the radio listening hobby. If you are looking to try something a bit different or to return to those early days of the radio art, this receiver will take you to all the right places. Personally, I plan to spend some time with this receiver on a regular basis, logging and QSLing stations the "old-fashioned" way. ■

A Pair of Appealing "Six-Shooters"

There are about a zillion antennas in the textbooks, and every now and then antennas from the deep, dark past come to the forefront again and regain some popularity. In this installment of Antennas 'n' Things, we are going to take a look of a pair of antennas that are sometimes called "Six-Shooters" (although "why" escapes me at the moment).

The Six-Shooters (Figs. 1 and 2) are variations of what are called "broadside arrays." The version shown in Fig. 1 basically is a small "Sterba curtain" array, larger versions often used by high-power international shortwave broadcasters. Both antennas can be fed with either 300-ohm twinlead, or with 75-ohm coaxial cable if a 4:1 balun transformer is provided at the feedpoint.

These antennas can be built of wire or aluminum tubing, although the wire option probably is the most popular. An advantage of these antennas is that they can be built for frequencies in the 6- to 7-MHz range (where wire construction is preferred), if you have enough room, and also well into the VHF region (in which case aluminum tubing construction is preferred).

One advantage of these antennas is that they have rather considerable gain; 6 dB in the case of Fig. 1 and 7.5 dB in the case of Fig. 2. The signal is bidirectional, and is broadside to the array (in and out of the page as you view Figs. 1 and 2). There are two uses for gain-in antennas.

First, antenna gain makes weak signals stronger by their own gain factor, without the extra added noise that a preamplifier introduces. If you can only afford either an antenna or a preamplifier, go for the antenna nine times out of 10. On most receivers, these antennas cause a signal to be about one S-unit stronger than the same signal received on a dipole (plus or minus a little bit). While one S-unit is not much to write home about at S9, it can be critical at S1.

Second, the gain is achieved by refocusing the pattern so that the maxima are broadside to the array, and there are nulls off the ends. These nulls can be positioned to reduce the signal level of an offending interfering signal on the same, or adjacent, channel. This may be the most important aspect to a directional gain antenna. The problem is one of signal-to-noise ratio (indeed, one of my college professors said that everything about receiving a signal is

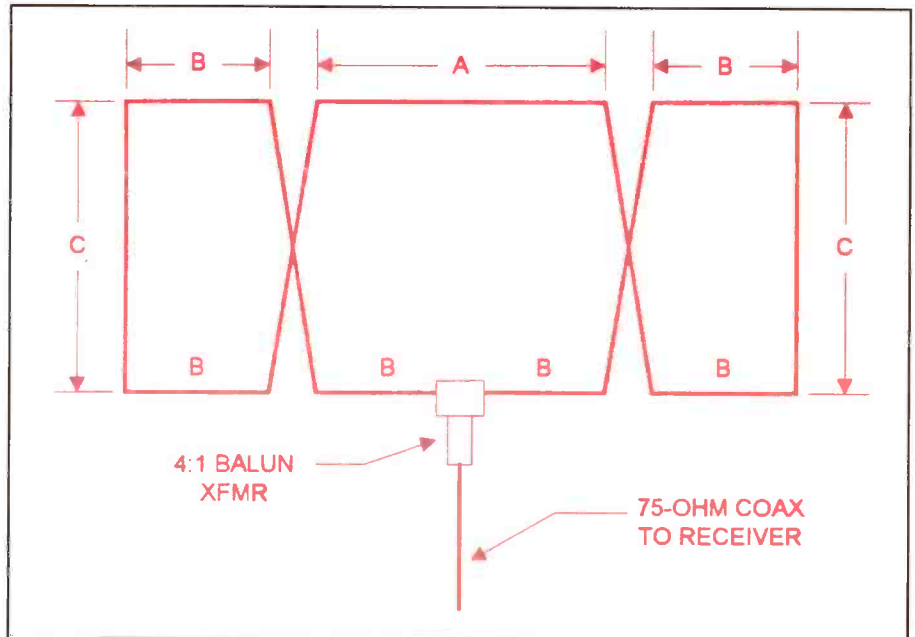

Type I ("micro-Sterba") Six-Shooter.

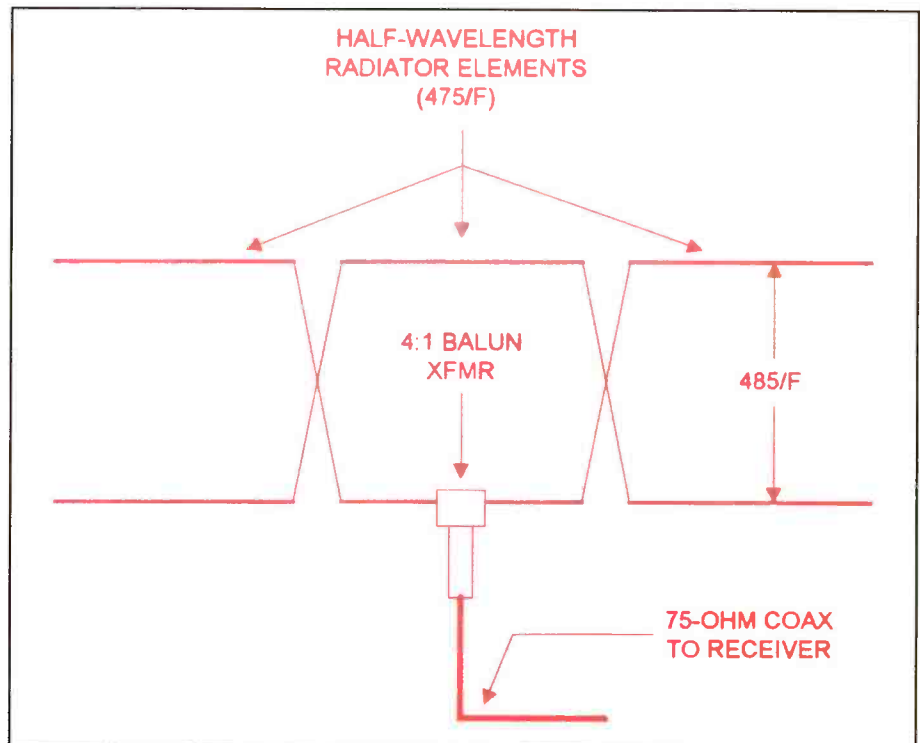

Type-II Six-Shooter.

a matter of managing SNR!). The nulls are sharper and deeper than the peaks, so it's possible to null the interfering signal more than the desired signal. So even if the maxima is not aimed directly at the desired signal, the overall performance is enhanced if the null is dead on the interfering signal.

The Six-Shooter in Fig. 1 (our micro-Sterba) uses elements of three different lengths, labeled A, B and C. These lengths (in feet) can be calculated from: $A_{\text{feet}} = 490/F_{\text{MHz}}$; $B_{\text{feet}} = A/2$; and $C_{\text{feet}} = 477/F_{\text{MHz}}$.

At 16 MHz, these lengths work out to be $A=30.6$ feet, $B=15.3$ feet and $C=29.8$ feet. At 162 MHz, $A=3$ feet, $B=1.5$ feet and $C=2.9$ feet.

The distance between horizontal elements should be 4 to 6 inches. In wire antennas, an ordinary end insulator placed between two elements usually will suffice.

The lengths of the elements in Fig. 2 are calculated as shown in the figure. The horizontal elements each are calculated from: $\text{Length}_{\text{feet}} = 475/F_{\text{MHz}}$.

Meanwhile, the vertical separation between the two rows of horizontal elements is calculated from: $\text{Length}_{\text{feet}} = 485/F_{\text{MHz}}$.

These two antennas are relatively easy to construct of either wire or tubing, and should be considered whenever you want gain on the cheap.

Safety First!

Sometimes someone will contact me at my e-mail address (carrji@aol.com) and ask something about antennas. One fellow (not a POP'COMM reader!) very carefully gave me details of his plan to erect a wire "top-hat T" antenna for the high-frequency shortwave bands. In his description, he mentioned he was going to use a wrench as a weight to toss a rope over the AC power lines coming into his home, and then pull the antenna wire over using insulated gloves.

I flamed him with my reply: Don't do it! It will kill you. Always keep well away from power lines. They may look insulated, but power line insulation can be cut by the antenna wire even when it's new. You have to be dumber than a box of rocks to try any variant of this often fatal maneuver!

Plan Yes, But DO IT!

A lot of people I talk to tell me that they want to erect that absolutely most perfect antenna possible, and they plan, and plan and plan. Some of their arguments sound like those I heard against buying the (then new-fangled) calculators that came on the market when I was in college. My approach was to survey what was available in scientific calculators within my price range, and then go buy the thing.

A friend of mine sneered that I'd paid

too much for my TI SR-50 because "... next year they're coming out with something that'll do more and cost less." Yes, that's the way the electronics industry worked. But when we were seniors, he still was looking for the magical, cheaper calculator in the sky and solving problems on a clumsy slip-stick ("slide rule" to the non-cognizent or younger readers); I had spent the last three years solving the same problems on a nice little calculator.

The point of this little analogy is that

sometimes one has to "fish or cut bait." While you're planning, an awful lot of good listening is going by the wayside.

What was so odd about the planner I told you about above is that his receiver did not warrant a whole lot of antenna. Once you get past a certain quality level, and start listening to weaker and harder-to-detect signals, then one can worry about fine differences between antennas. Until then, put something up and start listening. There's plenty of time to upgrade later on. ■

To Order Back Issues

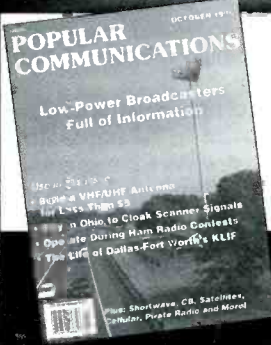

POPULAR COMMUNICATIONS
Low-Power Broadcasters
Full of Information

Send \$3.50 Per Issue

When ordering back issues include the following information: Name, address, city, state & zip. Please make a list of the issues you're requesting. When paying by credit card send the number along with the expiration date. Check, Money Order, Mastercard, VISA, Discover and AMEX accepted.

Complete your collection today.

1-800-853-9797

or Fax 1-516-681-2926

Popular Communications
76 North Broadway, Hicksville, NY 11801

PAY TV AND SATELLITE DESCRAMBLING

all new information 1996 Edition VOLUME 7

Pay TV and Satellite Descrambling Volume 1-7 (all different). Satellite & DBS hacking, Wireless Cable Hacking, Complete Wizard, Buying Surplus, Seized & Distressed Goods, Cellular Phone Hacking, Computer & Phone Hacking, all new Hacker Video. \$15.95 each, any 3/\$34.95 or any 5/\$52.95. American Hacker Magazine \$29.95 includes BBS. Our Best Deal is everything listed here and lots more for only \$129.95. New product catalog \$1. Add \$6 for C.O.D.'s.

SCRAMBLING NEWS
3494 DELAWARE AVE., #123, BUFFALO, NY 14217-1230
Voice/FAX (716) 874-2088 BBS (716) 871-1915
dlawson@localnet.com

CIRCLE 71 ON READER SERVICE CARD

Personal Code Explorer™



Only \$99

- ★ Novices
- ★ SWLs
- ★ Veterans

Receive Digital Signals

Copies MORSE, RTTY, FAX, SITOR, PACKET, and more from your receiver to IBM/PC. Easy hookup. No TNC needed! Easy to use. Extensive manual.

Versatile software/hardware package that copies the greatest variety of coded signals on the air. User friendly menus, digital noise filters, global frequency lists, FAX-GIF converter and more!

NOW SEE WHAT YOU'VE BEEN MISSING!

Personal Code Explorer - \$99 S&H \$4

Free Brochure. Call-Write-Order. MC/VISA.

Microcraft Corporation
Box 513PC, Thiensville, WI 53092
Phone (414) 241-8144

CIRCLE 65 ON READER SERVICE CARD

COMMODORE® USERS

SWL

SWL: A receive only cartridge for CW, RTTY (Baudot & ASCII) for use with Commodore 64/128. Operating program in ROM.....\$69.95
NOW \$29.95

ART-1: A complete interface system for send and receive on CW, RTTY (Baudot & ASCII) and AMTOR, for use with the Commodore 64/128 computer. Operating program on disk included...\$199.00
NOW \$49.95

AIR-1: A complete interface system for send and receive on CW, RTTY (Baudot & ASCII) and AMTOR, for use with Commodore VIC-20. Operating program in ROM.....\$99.95
NOW \$39.95

MORSE COACH: A complete teaching and testing program for learning the Morse code in a cartridge. For C64 or C128.....\$49.95
NOW \$19.95

ART-1

AIR-1

MORSE COACH

Limited Quantities--US orders add \$5 shipping

G AND G ELECTRONICS

OF MARYLAND

8524 DAKOTA DRIVE
GAITHERSBURG, MD 20877
(301) 258-7373



CIRCLE 59 ON READER SERVICE CARD

Telephones Enroute

BY TOM KNEITEL, K2AES

WHAT'S HAPPENING WITH CELLULAR, MARINE & MOBILE PHONES

The Cloning Conundrum

Some clarification probably is needed here: In the October 1995 Mailbag column, Allan, K1UCY, objected to what he termed "misleading" photo captions in *POP'COMM's* June issue feature about cloned cellphones. Those captions stated that when you talk on a cellphone, the unit is susceptible to being cloned. Allan wrote, "The truth is that if you have the phone turned on (to receive calls) but actually not talking on it, it still can be cloned."

While Allan's claim often is the case, the June issue captions were nevertheless factual. Allan's comment didn't prove them misleading. Allan's information represents good practice and has become the general rule of thumb, it is not a universal truth. For instance, it doesn't relate to my portable cellphone, and certainly not to many others. Try this on for size: My phone, for one, cannot be cloned while it's in standby/receive mode. Surely, the service provider I use can't be the only one

programming this fraud protection into subscribers' cellphones.

As soon as my cellphone is turned on to receive calls, it automatically transmits a distinctive coded fraud protection signal. This allows the unit to ring if any calls are sent to it. All the while it remains electronically invisible to would-be number counterfeiters. Incoming calls may be answered normally.

Unless I cause a certain fraud protection unlock code sequence to be transmitted before a call is placed, service providers will reject outgoing calls from my cellphone, despite its valid mobile identification (phone) number (the MIN) and electronic serial number (ESN). The only outgoing calls that may be dialed when the phone is in fraud protection mode are to 911 and the service provider's offices.

Yes, any time a call is in progress, the phone is susceptible to being cloned. When a call is over, the phone can be manually

reset into fraud protection-receive mode. Should I forget to do this, the fraud protection mode will automatically reset within 20 minutes.

This feature isn't inconvenient to use, and protects the cellphone from being cloned while standing by. If your cellphone doesn't have fraud protection programming, ask your provider about the no-cost service. If you can't get this service, the only way to achieve some degree of cloning-protection is by keeping your cellphone turned off except when making calls. At such times, your cellphone can't receive any calls.

Cordless Monitoring

An unsigned letter from a reader in Waterloo, Iowa, questions why this column has never made a big thing of about the fact that cordless phone monitoring recently has become illegal, as per the Electronic



Are cordless phone frequencies supposedly off limits to monitoring? See what this is all about in this month's column.

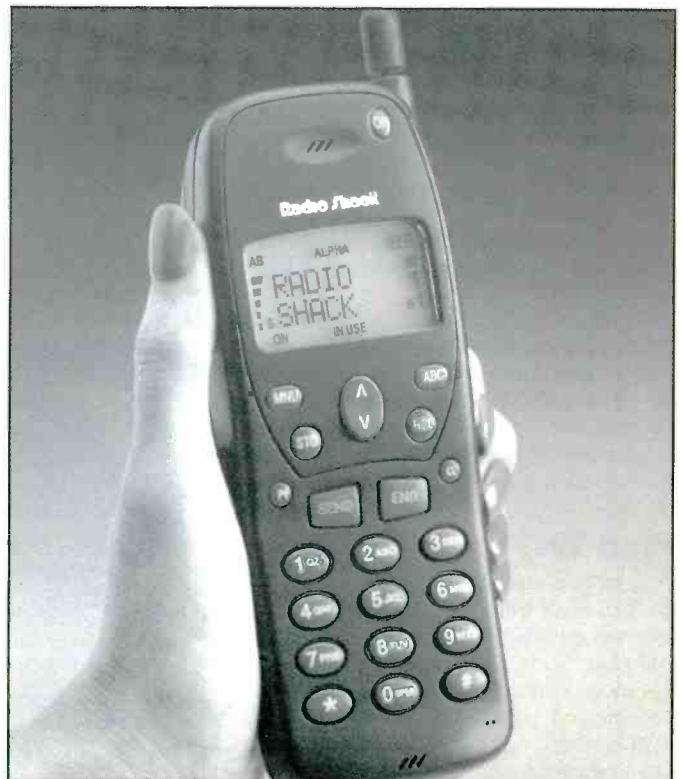

RadioShack's CT-352 handheld cellphone offers a lot of features in a small package.

Communications Privacy Act. He wrote that when the ECPA was created, cordless phones were specifically excluded from whatever protections the ECPA supposedly offers. However, our reader notes that Public Law 103-414 eliminated that portion of the ECPA stating, "transmissions between a cordless phone and a base unit are not covered by the act." Yet, he notes, this column has strangely ignored mention of Public Law 103-414.

Our anonymous reader observes that inasmuch as 49-MHz cordless handset frequencies are adjacent to the 50-MHz (6-meter) amateur band, 6-meter-band hams should be warned they are at risk of violating the ECPA. He's concerned about this impact on cordless monitoring in general, and asks our opinion.

Public Law 103-414 probably will have no direct effect on cordless monitoring, especially if worded as strangely as our reader reports it to be. That's because it seems to relate only to the 49-MHz handset transmissions from the handset to the base, and not vice versa. Cordless phone monitoring normally involves tuning in only the frequency band used by base units.

Can you spot something that did not occur to the geniuses who approved this new exclusion? It turns out that 49.6 to 50 MHz is allocated for federal station use, and fed stations are OK to monitor. Also, part of the "off-limits" 49-MHz cordless handset band is shared with other communications devices that are legal to monitor! That includes 49-MHz FM baby monitors, hands-free FM transceivers and Part 15 walkie-talkies.

Think about it: Let's say it is illegal to eavesdrop on cordless handset frequencies. But what are the ramifications in the event the cordless base frequencies also happen to be off-limits to monitoring by uninvited ears? Let me point out that all 15 newly added 43 and 44 MHz cordless base channels coincidentally are active frequencies in various land mobile radio services. Those services are legal to monitor. Also note the older 46-MHz base channels lie between 46.6 and 47 MHz, which is another band allocated for federal station use. You are allowed to monitor fed comms. So, unless they advise how scanners are supposed to weed out cordless base signals from legal signals, it nullifies a cordless monitoring restriction.

Next, think about how cordless base unit signals often inadvertently jam and interfere with other nearby cordless phones. Even cordless phone owners who accidentally overhear their neighbors' calls coming through on their own phone's channel would become instant lawbreakers.

So, as a realistic privacy issue, this cordless phone frequency exclusion is bogus. If any agency plans on trying to routinely collect evidence of violations, then press charges, we wish them luck.

You know that guy in your neighborhood who wears the Blue Oyster Cult 1982 Tour T-shirt? Right, the one who phones his girlfriend on the cordless every time his wife goes to the store. Will this public law cause you to stop listening to him? Do you think anyone else is going to suddenly divert their attention away from listening to popular frequencies tunable on practically every scanner manufactured during the last 28 years?

That's why Public Law 103-414 has been ignored here so far. I have no intention of suggesting to my intelligent readers that they seriously entertain the preposterous notion that, at this point, it has become a violation of a federal law to monitor cordless phone frequencies. Mind you, I am not suggesting that anyone break a law. But upon being asked, I am pointing out the absurdity of this one. Incidentally, also note that some states have anti-wiretap laws that specifically consider cordless phone monitoring illegal.

The federal cordless exclusion may be hilarious, but don't start laughing yet. There is an ominous factor lurking in the shadows of this circus of stupidity. It's that this is yet one more in the continuing parade of frequency encroachments. The feds appear to see a bountiful supply of frequency bands available for serving up on a silver platter to satisfy the desires of each and every commercial interest with big bucks and/or political clout.

In a news release issued in September 1995, the FCC described the electromagnetic spectrum as a "scarce public property," but complained that for years it was being "given away for free." The agency observed, however, that Congress gave them the authority in 1993 to start auctions, which generated more than \$9 billion in just over a year.

Auctions have included, for instance, 33 frequency channels in the 2150-2162 and 2500-2686 MHz bands. These are dedicated to the Multipoint Distribution Service (MDS), popularly referred to as "wireless cable TV." These channels are used to provide multichannel TV programming similar to cable TV, but using microwaves instead of hardwire. Licensees in 493 areas where MDS bids will be awarded are granted a protected 35-mile radius around their operations.

The FCC also is auctioning off 20 10-channel blocks in the 896-901 and 935-940 MHz bands. This is for trunked and conventional Specialized Mobile Radio Service (SMR) systems operating in 51 geographic areas. SMR includes dispatch, voice, data and fax services that have various business and specialized uses for hire to the public. Some systems are connected to the landline telephone network, and handle mobile phone calls.

The 1850-1990 MHz band, the location in the spectrum for the Broadband Per-

It's time you found out...

What over 185,000 people already know.

NOW YOU'RE TALKING!

was written with you, the reader, in mind.

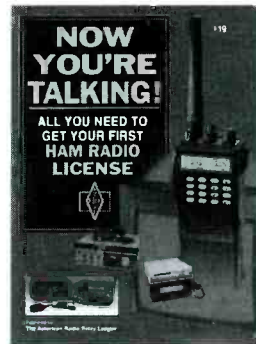

There's never been a more exciting time to get your Ham license. You can use Amateur Radio as a fun, friendly method of local communication, an invaluable tool in emergencies, or even experience the thrill of talking to Astronauts and Cosmonauts in orbit.

Whether you want to enter Amateur Radio as a Technician and choose to skip the code, or as a Novice licensee, *Now You're Talking* will provide you with the information you need in bite-size, easy-to-understand diagrams, photos and sketches, you'll be familiar with all the questions used to make up the FCC test...and you'll be ready for it.

In addition to study material that won't let you down, you'll find invaluable operating hints and tips you'll use once you pass your test. *Now You're Talking: All You Need to Get Your First Ham License* is the book you'll use even after you've passed your exam.

You can shop around for bargains, or you can join the thousands of licensed amateurs who have used *Now You're Talking* to pass their exam. Order your copy today:

Enclosed is \$19 plus \$4 for shipping (a total of \$23) or charge \$23 to my
 VISA Mastercard
 Discover American Express

**For more Information Call
1-800-326-3942**

Signature _____

Acct. No. _____

Expiration Date _____

Name _____

Address _____

City _____ State _____ Zip _____ PC

**THE AMERICAN RADIO RELAY LEAGUE
225 MAIN STREET
NEWINGTON, CT 06111**

WORLDS SMALLEST FM TRANSMITTERS

MICRO-MINIATURE FM TRANSMITTER!

In spite of its micro-miniature size, the XWB1000-EZ transmitter kit punches out a signal up to 1/2 mile away! Including the battery, this is absolutely the smallest FM transmitter available. Miniature battery and holder included on circuit board for minimum size. Amazing audio sensitivity. Picks up sounds at the level of a whisper. Use with any FM broadcast receiver from 88 to 108 MHz. XANDI's famous E-Z kit approach makes assembly a snap. Kit includes pre-assembled surface mount module, microphone, antenna wire, and battery.

● **XWB1000 E-Z \$46.95**

CRYSTAL CONTROLLED FM TRANSMITTER!

With a range of up to 1/2 mile, the new XTL1000-EZ transmitter KIT is an outstanding performer. Miniature battery and holder included on circuit board. Amazing audio sensitivity. Picks up sounds at the level of a whisper. Works with any VHF scanner or surveillance receiver at 143 MHz. XANDI's famous E-Z kit approach makes assembly a snap. Kit includes pre-assembled and tested surface mount module, microphone, antenna wire, and battery.

● **XTL1000 E-Z \$69.95**

LONG RANGE CRYSTAL CONTROLLED FM TRANSMITTER!

With a range of up to 1 mile, the new XTL3000-EZ transmitter E-Z KIT outperforms any other unit available. Miniature battery and holder included on circuit board. Amazing audio sensitivity. Picks up sounds at the level of a whisper. Works with any VHF scanner or surveillance receiver at 143 MHz. XANDI's famous E-Z kit approach makes assembly a snap. Kit includes pre-assembled and tested surface mount module, microphone, antenna wire, and battery.

● **XTL3000 E-Z \$89.95**

1-800-336-7389

SATISFACTION GUARANTEED.

CHECK, VISA, MC, MO
or COD, S&H EXTRA

ASK FOR OUR
NEW CATALOG!



XANDI Serving The Public Since 1981
ELECTRONICS, INC.
1270 E. BROADWAY RD #113, TEMPE, AZ 85282

CIRCLE 78 ON READER SERVICE CARD



THE BEST IN PERFORMANCE & QUALITY!

5 + 5 STAR

UPS SHIPPABLE

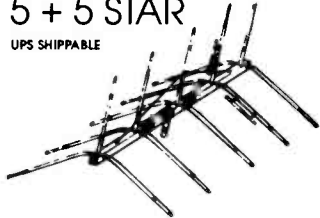

Other Models & Sizes
Available in 10 or 11 Meters

JO GUNN Enterprises
Route 1 Box 32C, Old Hwy 82
Ethelsville, Alabama 35461
(205) 658-2229 fax (205) 658-2259

Hours: 9am - 5pm (CST) Monday - Friday

Call or send \$2 for Complete Catalog
and Pricing of Antenna

DEALER INQUIRIES, PLEASE CALL

sonal Communications Services (PCS), is being auctioned, too. The nation is divided into 493 protected service areas to be awarded to bid winners. They will be permitted to provide a variety of commercial public services to compete with existing cellular, paging and other land mobile services. PCS uses small, lightweight, multi-function portable phones, even data, advanced paging and other devices.

The 218-219 MHz band has been assigned to the Interactive Video and Data Service (IVDS). The United States is divided into 734 geographic IVDS service areas. Auctions and lotteries have been used to distribute IVDS authorizations, with two per service area. Each operator is awarded the locally protected use of half the band (500 kHz). IVDS is an interactive TV service that allows viewers to shop, bank, participate in opinion polls and game shows, etc., from home.

Remember when the 800 MHz cell-phone bands were turned over to private industry and made off limits? The protected cordless phone channels are but a tiny ripple on the dark waters of things like cell-phones and worse. Dozens of influence peddlers are in Washington right now demanding more telecommunications concessions. Such demands are met with grants of franchised frequency bands embellished with exclusive, protected, private or off-limits status. Politicians and bureaucrats see it as a great way of raising cash.

A modern scanner covering the standard VHF low, VHF high, UHF, UHF-T, 806 to 900 MHz communications bands, and VHF/UHF aeronautical bands, receives about 412 MHz worth of spectrum. There is a frequency crunch as advanced new telecommunications technologies are developed. More than half (about 230 MHz worth) of a scanner's frequencies between 30 and 900 MHz already are reserved for the exclusive use of federal stations. On top of this, we are now accommodating private interests by reserving or auctioning off other bands throughout the spectrum.

When Washington is finished carving up and distributing protected private slices of this scarce natural resource, will there still be a few frequencies left for the public to legally use and monitor?

What do you think? Please let me know.

Pick-a-Lock

As you know, as per FCC restrictions, scanners manufactured after April 1994 have the two cellular bands factory blocked to the point where restoration by users is unfeasible. In many older 800 MHz scanners, of course, restoration to full 800 MHz coverage is possible, and often rather simple. Today, full coverage 800 MHz scanners, in good used condition, are worth

more than when they were new.

A great alternative approach has been by the use of outboard downconverter accessories that pick up all 800 to 900 MHz frequencies and shifts them to 400 to 500 MHz. This allows scanners to receive the cellular bands. Manufacture of 800 MHz converter accessories also was stopped by the FCC. The remaining inventories were quickly snapped up by astute scanner owners. Now comes a new idea.

My good friend, Tom Bernie at Cellular Security Group in Gloucester, Mass., tells me that several new "unrestorable" scanners can be "virtually unlocked." He reports that WA1YKL has developed a procedure whereby an external switch or internal relay with related wiring are added to the existing internal components of a scanner. These are configured to create a switchable, internal downconverter that allows full reception of the 800 MHz band on a VHF or UHF band.

This Virtual 800 MHz Down Converter presently can be installed in only the following: RadioShack PRO-23, PRO-26, PRO-29, PRO-51, PRO-2035; and Uniden Bearcat BC-220, BC-860, BC-3000, BC-8500, and BC-9000. Additional models will be added as time goes on. Cellular Security Group is doing all the bench work.

Cellular Security Group charges \$99, including return shipping. They have had so many orders for this that customers need to call first for a reservation number. Let Tom know we sent you. The phone number is (508) 281-8892; fax (800) 487-7539. By the way, Tom's Internet e-mail address is tombertnie@msn.com.

How About a Hand?

RadioShack's CT-352 handheld cell-phone combines a lot of features into a small, easy-to-use package.

Some of the features packed into the CT-352 include any-key answering, dual NAM capability to allow registration with two different service suppliers, 98 speed-dial memories, four one-touch dial-up memories for emergency or priority numbers, redial and versatile call timer. Dial persons by their name if you want, and scan the memory locations to look up numbers and names. You can shut off the ringer and get silent reception of incoming calls.

The rechargeable battery provides 10 hours of standby and nearly an hour of talk time. It's a rather a good-looking set, too. You can see this at any RadioShack store.

Input to "Telephones Enroute" is sought in the form of comments, news clippings, questions and opinions relating to cellulars, beepers and all personal wireless services. This column also seeks new product information and photos, as well as information from service providers. Please indicate "For Telephones Enroute" in the address of all material directed to this column. ■

Clandestine Communique

WHAT'S NEW WITH THE CLANDESTINES

Iranian Clandestine Shuts Down

One of the better known Iranian clandestine stations, the Voice of Human Rights and Freedom for Iran, has closed down. The station, long believed to be an operation backed by the U.S. government, discontinued operations at the end of September—the day its funding ran out and, coincidentally, the close of the U.S. government's fiscal year, according to a source within the Iranian opposition.

The loss of financial support meant it no longer could pay rent on the Egyptian government transmitters it was using. The station was fairly easily heard in North America, using frequencies such as 9255, 9270 and 11470 kHz. Thanks to George Zeller in Ohio for sending along this info.

Voice of the Communist Party of Iran—or Seda-ye Hezb-e Komunist-e Iran—operates in Farsi from 1430-1510, 1630-1715 and 0230-0330 on 4190. A related station is run by the Kurdish communists. Operates in Kurdish from 0300-0400, 1430-1530 and 1630-1730 on 3888 variable.

The Voice of Iranian Kurdistan is operating on 4195 between 0230 and 0315 and 4180 from 1350-1425. This station's transmitters are in northern Iraq. This station has an address of: KPDI, c/o AFK, B.P. 102, F75623 Paris, Cedex, France. These low-frequency Middle East stations are quite difficult to hear in North America, but can be picked up once in awhile. Folks in the eastern time zone have the best chance. Try for those transmissions that occur in our local evening hours.

The Voice of Eritrea, which appears to be one of the several clandestine "stations" aired by the Iraqi government over its own transmitters, is being heard on 17740 between 1700 and 1800 with programming in Tigrena and Arabic, but suffering from some jamming.

What seems to be a new anti-Iraq station is the Voice of the People of Iraq—Voice of Democracy, coming on the air sometime between 1728 and 1735 on a frequency varying between 5825 and 5835. It's thought that this operation is based in Syria.

The Voice of Abkhazia speaks for those who want independence for the Abkhazia area of the former Soviet state of Georgia. It is operating 0330-0445 on 9495, or a hair below.

Zeller has been following the story of La Voz de Chiapas Libre, which claims to

THIS WILL VERIFY RECEPTION OF
LA VOZ DEL CID
6306 kHz

Jill Dybka, we confirm reception on:
6306 kHz
0410-0500 hrs. UTC
28 April 1995

Signature/Stamp/Remarks: *Cid*
Georg De Pauw

✱

Jill Dybka in Tennessee got this card from the anti-Castro La Voz del CID. The Cuban government continues jamming efforts against CID and other anti-Castro voices.

operate from the Mexican state of Chiapas and other areas in southern Mexico and northern Guatemala. Spokesman Jay Murley of California says the station took a direct mortar hit during a skirmish with Mexican Federal troops last summer and needs to be fully re-equipped. He claims that eight people have reported reception of the station's intermittent broadcasts that contain both propaganda and military traffic.

Murley claims the most distant of the reports was Key West, Fla. He says that, most recently, the station has been using the 39-meter band—the low end of the 7 MHz area, though it has tried the "fringes of the ham 80- and 160-meter bands." Zeller still has strong doubts that this station ever really existed, as does your editor. Neither of us have seen any loggings reported and we both have access to the work of some of the top shortwave monitors in the world.

American Dissident Voices, the neo-fascist broadcast of the National Alliance that airs on WRNO, now has a site on the Internet's World Wide Web at <http://www.natvan.com>. An alternate is <ftp://ftp.net.com> and use the path: pub/NA/NA.

Here's a survey of the quasi-clandestine programming currently aired on WHRI: Anti-Castro Alpha 66, Monday through Friday at 0700-0800 and 2200-2300 on 9495 and 15105; La Voz de Fundacion

(also anti-Castro), Monday-Saturday at 2300-0100 on 9495 and 15105; Radio Marti, Monday-Saturday, 0100-0400, on 9495 and 15105; Cuba 21, 0000-0030 Sundays on 9495 and 15105. All of these are in Spanish, of course. Also, The Voice of Democracy (in Vietnamese) airs at 1300, Monday to Friday, on 9930 (KWHR-Hawaii). Another Vietnamese program is Forum for Democracy, which airs Saturdays and Sundays at 1400-1430 on 9930. The times and frequencies for all these tend to change rather frequently so if you're interested in hearing these you might want to get on the mailing list for the WHRI schedule. Write to P.O. Box 12, South Bend, IN 46224.

Radio Rutemorangingo is a new station reported active, broadcasting in opposition to the current government of Burundi and believed to be operating from Zaire. Its 90-meter band frequency wasn't specified, nor was the schedule.

That covers things this time. Remember, your input on clandestine broadcasting always is greatly appreciated. This includes station loggings and operating schedules, addresses, QSL news and copies of QSLs or literature from stations or their backing organizations, new station news and so on. Your help always is very much appreciated.

Until next month, good hunting! ■

You Should Know

BY CAPT. WILLIAM MAULDIN, WG4R

INTERESTING THOUGHTS AND IDEAS FOR ENJOYING THE HOBBY

Interesting ACARS

The subject of data communications has long been my primary interest. Radioteletype, or RTTY as it is known on the amateur radio bands, was responsible for getting me into ham radio. Today, there are so many different modes of data communications that it is almost impossible to keep up. One of the most interesting, and the most rapidly expanding, is ACARS, officially known as the Aircraft Communications Addressing and Reporting System.

ACARS can be monitored in most all geographic areas. In the United States, although there are some backup channels, 131.550 MHz is the primary channel used for most transmissions. This is a common channel found on most scanners. Remember, all aircraft transmissions are in AM. If you have doubt about being able to monitor ACARS, enter 131.550 MHz in your scanner and spend a few minutes listening. The buzzing sounds that you'll soon be hearing are the data transmissions from planes in flight. If you are close to a ground ACARS transmitter, you also will be hearing the ground station transmissions.

ACARS is much like amateur packet in that a part of each sending and receiving station actually is a computer. The computers monitor the frequency and make sure it is clear before sending a message. Mixed transmissions on ACARS do not take place very often.

The commercial airlines and other commercial users have been using ACARS for many years. Initially, it was just a way to send printed data to aircraft in flight. After a successful test, the airlines expanded their use of the system. For example, ACARS-equipped aircraft now send the OUT, OFF, ON and IN times automatically. As you may or may not know, most airline crews are paid by the minute. A minute added here and there can cost an airline payroll considerable money. Keeping track of the OUT (the time the plane actually is pushed off the gate) and the IN (the time the plane is parked at the gate) times can save a company considerable money. Also, by knowing when the plane is OFF the ground and ON the ground, the hourly costs on airframe and engines can be better controlled.

Before we expand on what is happening to ACARS, let me explain how the system computer knows what the plane is doing on the ground. Each airline seems to have a slightly different way of telling the ACARS computer what is going on. For example, the OUT time can be detected by the

ACARS computer when the passenger door is closed and the parking brakes are released. Other airlines use two other actions such as the red rotating beacon being turned on and the last access door to the plane being closed. The reverse of the same two items activate the IN time to be sent by ACARS. Switches on the landing gear extension struts activate the OFF and ON time programs in the ACARS computer.

Once the airlines were aware of how much they could program into the ACARS computer, they started adding more uses. If you are an avid aviation band listener, you have probably heard airliners holding for takeoff, waiting for their "numbers" from the company. In years past, operations agents either handed the pilots their last-minute weight-and-balance figures on paper or voiced them over the local company frequency. Today, weight and balance figures, passenger totals and fuel-release information is transmitted to the pilots after pushback via ACARS. American Airlines has an exceptionally good "numbers" ACARS program. The takeoff speeds also are computed and added to this report, making the pilots' jobs easier and cutting the risks of possible mistakes.

The door for fast data information exchange between the ground and aircraft in flight has just started to open. Today, ACARS is a primary instrument in most advanced cockpits. The once single-line display screen has changed into a small computer screen with vast multiple functions and a touch screen. A printer has been added also. But, even this advancement tells little about what is happening to and with ACARS.

Pilots can finger touch the menus on the current DataLink computer screens and send messages to the company flight dispatcher, the maintenance coordinator, the passenger service agents, and much more. Current weather reports, forecasts, field conditions and arrival gate assignments can be quickly called up by just the touch of a menu. The "predeparture clearance," or PDC, also is requested and received via ACARS. Pilots also can send typed messages and reports to many company departments, advising of weather turbulence or passenger problems by touching the complete keyboard displayed on the DataLink computer screens. In the more advanced planes, flight attendants also have their own ACARS computer touch screen in the back of the plane. From this pas-

senger service position, things such as wheelchairs, passenger assistance and catering problems can be resolved without going to the cockpit.

Safety also is being improved by the expanded use of ACARS. Fast action touch menus allow flight crew members to advise the dispatcher of just about any emergency situation. Later, when the emergency has been resolved or cockpit workload has been reduced, additional information can be passed along either by ACARS or voice transmission.

As the system is being expanded, ACARS is being assigned information collection tasks that don't involve the flight crew members. One of the latest non-pilot-activated tasks involves the reading of cockpit engine information, with automatic transmission to the company maintenance computer. Ground engineers and maintenance personnel can tell when an engine is becoming worn or has a problem.

The very latest task assigned to ACARS is the automatic sending of the aircraft position to the company every two minutes! Flight-following computers in the dispatch headquarters automatically enter this information. On large display screens in the flight dispatch headquarters, each ACARS-equipped plane is displayed clearly, and the position is updated every two minutes until the plane is on the ground. Company arrival information, weather deviations and FAA requirements can be met with ease when automatic ACARS position reading is used. It is truly an impressive display. If you ever take the airline company tour, ask to see the large, command post-type plane location display.

How do you copy ACARS and how do you read the information that is displayed? This can be a bit of a problem for the novice, however, with the proper manuals and a little help, it can be easy and fun. Several of the radio hobby dealers manufacture and sell the data terminal units and books on the subject. Because each airline generally treats their ACARS information format a little differently, you do need a book on the subject. Universal Radio, a POP'COMM advertiser, offers a good book and a nice terminal unit. Others are appearing on the market as the interest in ACARS grows.

When I first monitored ACARS, I was a bit disturbed when some of the solid, soundly copied data bursts did not print on my ACARS decoder or on my computer

(Continued on page 77)

Tap into secret Shortwave Signals

Turn mysterious signals into exciting text messages with this new MFJ MultiReader™



MFJ-462B Plug this self-contained MFJ MultiReader™ into your shortwave receiver's earphone jack.

Then watch mysterious chirps, whistles and buzzing sounds of RTTY, ASCII, CW and AMTOR turn into exciting text messages as they scroll across your easy-to-read LCD display.

You'll read interesting commercial, military, diplomatic, weather, aeronautical, maritime and amateur traffic... traffic your friends can't read -- unless they have a decoder.

Eavesdrop on the World

Eavesdrop on the world's press agencies transmitting *unedited* late breaking news in English -- China News in Taiwan, Tanjug Press in Serbia, Iraqi News in Iraq -- all on RTTY.

Super Active Antenna

"World Radio TV Handbook" says MFJ-1024 is a "first rate easy-to-operate active antenna... quiet... excellent dynamic range... good gain... low noise... broad frequency coverage."

Mount it outdoors away from electrical noise for maximum signal, minimum noise. Covers 50 KHz to 30 MHz.

Receives strong, clear signals from all over the world. 20dB attenuator, gain control, ON LED. Switch two receivers and aux. or active antenna. 6x3x5 in. remote has 54 inch whip, 50 ft. coax. 3x2x4 in. 12 VDC or 110 VAC with MFJ-1312, \$12.95.

\$129.95 MFJ-1024 MFJ-1312, \$12.95.

Indoor Active Antenna



Rival outside long wires with this *tuned* indoor active antenna. "World Radio TV Handbook" says MFJ-1020 is a "fine value... fair price... best offering to date... performs very well indeed."

Tuned circuitry minimizes intermod, improves selectivity, reduces noise outside tuned band. Use as preselector with external antenna. Covers 0.3-30 MHz. Has Tune, Band, Gain, On/Off/Bypass controls. Detachable telescoping whip. 6x2x6 in. Use 9 volt battery, 9-18 VDC or 110 VAC with MFJ-1312B, \$12.95.

Compact Active Antenna



Plug this new compact MFJ all band active antenna into your general coverage receiver and you'll hear strong clear signals from all over the world from 300 KHz to 200 MHz -- including low, medium, shortwave and VHF bands. Also improves scanner radio reception on VHF high and low bands.

Detachable 20 in. telescoping antenna. 9 volt battery or 110 VAC with MFJ-1312B, \$12.95. 3 1/8 x 1 1/4 x 4 in.

Copy RTTY weather stations from Antarctica, Mali, Congo and many others. Listen to military RTTY passing traffic from Panama, Cyprus, Peru, Capetown, London and others. Listen to hams, diplomatic, research, commercial and maritime RTTY.

Listen to maritime users, diplomats and amateurs send and receive error free messages using various forms of TOR (Telex-Over-Radio).

Monitor Morse code from hams, military, commercial, aeronautical, diplomatic, maritime -- from all over the world -- Australia, Russia, Hong Kong, Japan, Egypt, Norway, Israel, Africa.

Printer Monitors 24 Hours a Day

MFJ's exclusive TelePrinterPort™ lets you monitor any station 24 hours a day by printing their transmissions to your Epson compatible printer.

Printer cable, MFJ-5412, \$9.95.

MFJ MessageSaver™

You can save several pages of text in 8K of memory for re-reading or later review.

High Performance Modem

MFJ's high performance phaselock loop modem consistently gives you solid copy -- even with weak signals buried in noise. New threshold control minimizes noise interference -- greatly

improves copy on CW and other modes.

Easy to use, tune and read

It's easy to use -- just push a button to select modes and features from a menu.

It's easy to tune -- a precision tuning indicator makes tuning your receiver easy for best copy.

It's easy to read -- the 2 line 16 character LCD display with contrast adjustment is mounted on a sloped front panel for easy reading.

Copies most standard shifts and speeds. Has MFJ AutoTrak™ Morse code speed tracking.

Use 12 VDC or use 110 VAC with MFJ-1312B AC adapter, \$12.95. 5 1/4 x 2 1/2 x 5 1/4 inches.

No Matter What Guarantee

You get MFJ's famous one year *No Matter What™* unconditional guarantee. That means we will repair or replace your MFJ MultiReader™ (at our option) *no matter what* for a full year.

Try it for 30 Days

Order an MFJ-462B MultiReader™ from MFJ and try it in your own setup -- compare it to any other product on the market regardless of price.

Then if you're not completely satisfied, simply return it within 30 days for a prompt and courteous refund (less shipping).

Order today and try it -- you'll be glad you did.

Receive Color News Photos, MFJ 12/24 Hour LCD Clocks, Weather Maps, RTTY, ASCII, Morse Code



MFJ-1214PC **\$149.95**
Use your computer and radio to receive and display brilliant full color FAX news photos and incredible WeFAX weather maps with all 16 gray levels. Also RTTY, ASCII and Morse code.

Animate weather maps. Display 10 global pictures simultaneously. Zoom any part of picture or map. Frequency manager lists over 900 FAX stations. Automatic picture capture and save.

Includes interface, easy-to-use menu driven software, cables, power supply, comprehensive manual and Jump-Start™ guide. Requires 286 or better computer with VGA monitor.

Super Hi-Q Loop™ Antenna

The Super Hi-Q MFJ-1782 Loop™ is a **\$269.95** professional quality remotely tuned 10-30 MHz high-Q antenna.

It's very quiet and has a very narrow bandwidth that reduces receiver overloading and out-of-band interference.

High-Q Passive Preselector



MFJ-956 **\$39.95**
The MFJ-956 is a high-Q passive LC preselector that lets you boost your favorite stations while rejecting images, intermod and other phantom signals. Covers 1.5-30 MHz. Has preselector bypass and receiver grounded position. 2x3x4 in.

Mobile Scanner Ant.

Cellular MFJ-1824BB/BM **\$19.95**
look-a-like. Covers 25-1300 MHz. Highest gain on 406-512 and 108-174 MHz, 19 in. Magnet mount. MFJ-1824BB has BNC/UHF plug; MFJ-1824BM has Motorola plug.

MFJ Antenna Matcher



MFJ-959B **\$89.95**
Matches your antenna to your receiver so you get maximum signal and minimum loss.

Preamp with gain control boosts weak stations 10 times. 20 dB attenuator prevents overload. Pushbuttons let you select 2 antennas and 2 receivers. Cover 1.6-30 MHz. 9x2x6 inches. Use 9-18 VDC or 110 VAC with MFJ-1312, \$12.95.

High-Gain Preselector



MFJ-1045C **\$69.95**
High-gain, high-Q receiver preselector covers 1.8-54 MHz. Boost weak signals 10 times with low noise dual gate MOSFET. Reject out-of-band signals and images with high-Q tuned circuits. Pushbuttons let you select 2 antennas and 2 receivers. Dual coax and phone connectors. Use 9-18VDC or 110 VAC with MFJ-1312B, \$12.95.

Dual Tunable Audio Filter

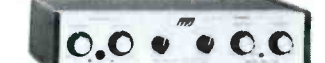

MFJ-752C **\$99.95**
Two separately tunable filters let you peak desired signals and notch out interference at the same time. You can peak, notch, low or high pass signals to eliminate heterodynes and interference. Plugs between radio and speaker or phones. 10x2x6 in.

Easy Up Antennas Book

How to build MFJ-38 **\$16.95** and put up inexpensive, fully tested wire antennas using readily available parts that'll bring signals in like you've never heard before.

Covers receiving antennas from 100 KHz to almost 1000 KHz. Includes antennas for long, medium and shortwave, utility, marine and VHF/UHF services.

MFJ-107B MFJ-108B MFJ-105B



MFJ-108B, dual clock displays 24 UTC and 12 hour local time simultaneously. MFJ-107B, single clock shows you 24 hour UTC time. 3 star rated by Passport to World Band Radio!

MFJ-105B, accurate 24 hour UTC quartz wall clock with large 10 inch face.

MFJ Antenna Switches



MFJ-1704 heavy duty antenna switch lets you select 4 antennas or ground them for static and lightning protection. Unused antennas automatically grounded. Replaceable lightning surge protection device. Good to 500 MHz. 60 dB isolation at 30 MHz. MFJ-1702B for 2 antennas.

World Band Radio Kit

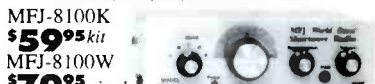

MFJ-8100K **\$59.95** kit
MFJ-8100W **\$79.95** wired
Build this regenerative shortwave receiver kit and listen to shortwave signals from all over the world with just a 10 foot wire antenna.

Has RF stage, vernier reduction drive, smooth regeneration, five bands.

Free MFJ Catalog

Write or Call toll free... 800-647-1800

Nearest Dealer/Orders: 800-647-1800
Technical Help: 800-647-TECH(8324)
• 1 year unconditional guarantee • 30 day money back guarantee (less s/h) on orders from MFJ • FREE catalog

MFJ ENTERPRISES, INC.
Box 494, Miss. State, MS 39762
(601) 323-5869; 8-4:30 CST, Mon.-Fri.
FAX: (601) 323-6551; Add s/h
MFJ... making quality affordable

Prices and specifications subject to change © MFJ Enterprises, Inc.

POP'COMM's World Band Tuning Tips

March 1996

This POP'COMM feature is designed to help you hear more shortwave stations. Each month this handy, pullout guide shows you when and where to tune to hear a wide variety of local and international broadcasters on the shortwave bands. The list includes broadcasts in languages other than English. Most of the transmissions are not beamed to North America. Keep in mind that stations make frequent changes in their broadcasting times and frequencies.

Changes in propagation conditions may make some stations difficult or impossible to receive. Your equipment and receiving location also will have a bearing on what you are able to hear.

Note: EE, FF, PP, etc., are abbreviations for English, French, Portuguese, and so on. Some frequencies may vary slightly. All times are in UTC, which is five hours ahead of Eastern Standard Time (i.e., 0000 UTC equals 7 p.m. EST).

Freq.	Station/Country	UTC	Freq.	Station/Country	UTC
3220	HCJB, Ecuador	0200	5055	TIFC, Costa Rica	0400
3225	Radio Maya de Barillas, Guatemala	0200 SS/local	5498	Radio Lajas, Peru	0200 SS
3280	La Voz del Napo, Ecuador	1000 SS	5770	Radio Miskut, Nicaragua	2345 s/off
3290	Namibian Broadcasting Corp.	0400	5850	Monitor Radio, USA	0500
3300	Radio Cultural, Guatemala	0300	5895	Croatian Radio	0400
3306	ZBC Radio 2, Zimbabwe	0400 vern	5930	Radio Prague, Czech Rep., via Slovakia	0230
3325	Radio Maya, Guatemala	1100 SS	5955	Channel Africa, South Africa	0400
3330	CHU, Canada	0200	5965	Radio Budapest, Hungary	0330
3360	La Voz de Nahuala, Guatemala	1100	5995	Radio Australia	1300
3366	GBC, Ghana	0600	6005	RAI, Italy	0130 II
3380	MBC, Malawi	0330 vern/EE	6015	Radio Austria International, via Canada	0530
3935	Radio Reading Service, New Zealand	0900	6020	Radio Australia	0800
3955	Channel Africa, South Africa	0330	6025	Radio Amanecer, Dominican Rep.	0200 SS
4005	Vatican Radio	0500 FF/EE	6050	Radio Nigeria	0600
4183	Radio 11 de Octubre, Bolivia	0300 SS	6060	Radio Nacional, Argentina	0900 SS
4485	Radio Frecuencia VH, Peru	0300 SS	6080	Radio Australia	0800 Pidgin EE
4615	Republic of Iraq Radio	0150 s/on, AA	6089	Radio Nigeria, Kaduna	0430
4725	Radio Myanmar (Burma)	1200 Burmese	6100	Radio New Zealand	0800
4755	Radio Educadora Rural, Brazil	0100 PP	6105	Radio Universidad, Costa Rica	0100 SS
4760	Trans World Radio, Swaziland	0300	6110	Radio Japan, via Canada	1100
4779	Radio Cultural, Coatan, Guatemala	0100 SS	6115v	La Voz del Llano, Colombia	0100 SS
4785	Ecos del Combeima, Colombia	0200 SS	6120	Radio Canada International	0200
4790	Radio Atlantida, Peru	0300 SS	6135	Swiss Radio International	0100
4805	Radio Amazonas, Brazil	2300 PP	6150	AWR, Costa Rica	2300
4820	La Voz Evangelica, Honduras	0300	6170	Radio Cultura, Brazil	0900 PP
4830	Radio Tachira, Venezuela	0200 SS	6175	BBC, via Canada	0000
4845	ORTM, Mauritania	0630 FF	6200	Radio Prague, Czech Republic	0100
4865	La Voz del Cinaruco, Colombia	0100 SS	6570	Defense Forces Radio, Myanmar	1200 Burmese
4885	Ondas del Meta, Colombia	0200 SS	7105	Voice of Russia	0200
4890	Radio France International, via Gabon	0500 FF	7120	Radio Sweden	0300
4904.5	Radiodiffusion Nationale, Chad	0500 FF	7147v	Republic of Iraq Radio	0158 s/on AA
4915	GBC, Ghana	0600	7160	Radio Tirana, Albania	0130
4920	Radio Quito, Ecuador	0200 SS	7185	Radio Bangladesh	1230
4930	Radio Internacional, Honduras	0200 SS	7215	Voice of UAE, Abu Dhabi	0200 s/on AA
4934	Radio Tropical, Peru	0400 SS	7250	Voice of Vietnam, via Russia	0200
4955	Radio Nacional, Colombia	0300 SS	7260	VOIRI, Iran	0030
4960	HRET, Honduras	0230 SS	7290	Radio Tanzania, via South Africa	0300
4985	Radio Brazil Central, Brazil	0900 PP	7300	Radio Slovakia International	0100
4990	Radio Apinte, Surinam	0300	7345	Radio Prague, Czech Republic	0600
5020	SIBC, Solomon Islands	1000 EE	7370	Croatian Radio	2300
5040	La Voz del Upano, Ecuador	0130 SS	9390	RFPI, Costa Rica	0300
5045	Radio Cultura do Para, Brazil	0230 PP	9420	Voice of Greece	0130

Freq.	Station/Country	UTC	Freq.	Station/Country	UTC
9445	Voice of Turkey	2330 TT	11900	Radio Finland International	1530
9475	Radio Cairo, Egypt	0200	11925	Radio Bandeirantes, Brazil	0000 PP
9510	Radio Australia	1300	11955	Radio Nacional Angola	2300 PP
9525	Voice of Indonesia	1200 II	11970	Voice of UAE, Abu Dhabi	2200
9535	Swiss Radio International	0500	11990	Radio Kuwait	1900 AA
9535	Radio Japan	0500	12005	RTV Tunisienne, Tunisia	1900 AA
9540	Radio Espana Exterior, Spain	0100	12075	Swiss Radio International	1830 FF
9560	Radio Norway	0100	12085	Radio Damascus, Syria	2030
9560	China Radio International, via Canada	0400	13635	Swiss Radio International, via Fr. Guiana	0030
9570	Radio Portugal	0230	13670	Radio Vlaanderen International, Belgium	1300
9570	Radio Romania International	0200	13675	UAE Radio, Dubai	1630
9580	Africa Number One, Gabon	1900 FF	13740	Radio Sweden	1130
9580	Radio Yugoslavia	0000	13760	Radio Pyongyang, North Korea	0000
9585	Channel Africa, South Africa	0400	13765	Vatican Radio	2000 GG
9590	Radio Singapore	1330 CC	15009	Voice of Vietnam	1330
9590	Radio Netherlands, via Bonaire	0400	15095	Radio Damascus, Syria	2030
9615	KNLS, Alaska	0800	15115	Radio New Zealand	0000
9625	CBC Northern Quebec Service	2200	15160	Radio Algiers, Algeria	1800
9655	Radio Austria International	0230	15170	Radio Jordan	1100
9675	Spanish National Radio	2200	15180	Voice of Russia	0300
9690	China Radio International, via Spain	0300	15190	Radio France International	2300 SS
9700	Radio Bulgaria	0000	15210	Radio France International	1700 FF
9700	Radio New Zealand International	1100	15240	Radio Australia	0400
9725	RAI, Italy	0100	15240	Radio Sweden	1330
9730	China Radio International, via Fr. Guiana	0400	15244	La Voix du Zaire	1800
9735	Radio Nacional, Paraguay	0100 SS	15265	Radiobras, Brazil	1700
9750	Radio Japan	1400	15270	Radio Intercontinental, Armenia	1730 EE/GG
9755	Radio Canada International	0000	15315	Radio Netherlands, via Bonaire	1830
9770	Voice of UAE, Abu Dhabi	2300	15345	RTV Marocaine, Morocco	1800 AA
9779	Republic of Yemen Radio	0300 AA	15350	Voice of Turkey	1330 s/on TT
9805	Radio France International	1200	15365	Radio France International	1230
9820	Radio Havana Cuba	0100 USB	15400	Radio Finland International	1330
9825	Radio Kiribati	0600	15405	Radio France International	1400
9835	Radio Budapest, Hungary	0100	15415	Radio Jamahiriya, Libya	0230 AA
9840	Radio Kuwait	0500 AA	15445	Radiobras, Brazil	1200
9850	Radio Sweden	1100 Swedish	15475	Africa Number One, Gabon	2100 FF
9870	Radio Austria International	0130	15490	HCJB, Ecuador	1800
9900	Radio Cairo, Egypt	2300	15505	Radio Kuwait	1700 AA
9905	Swiss Radio International, via Fr. Guiana	0500	15530	RAI, Italy	2200
9977	Radio Pyongyang, North Korea	1130	15565	Radio Australia	1200
11580	Radio Moldova International, via Romania	1930	15570	Vatican Radio	1745
11603	Kol Israel	1900	15575	Radio Korea, South Korea	0030
11620	All India Radio	1900	15590	Vatican Radio	1345
11650	Radio Sweden	1200	15630	Voice of Greece	1430 GG
11670	Radio France International, via Fr. Guiana	0130 SS	15640	Kol Israel	1515
11685	Kol Israel	1900	15665	Monitor Radio, USA	1800
11705	Radio Havana Cuba	2100	15675	Radio Copan International, Honduras	2300 SS
11710	RAE, Argentina	0200 EE	17500	RTT, Tunisia	1330 AA
11715	China Radio International, via Mali	0300	17525	Voice of Greece	1330 GG/EE
11720	Radio Bulgaria	2100	17545	Reshet Bet Service, Israel	1200 HH
11730	Trans World Radio, via South Africa	0600	17595	Radio Cairo, Egypt	1230
11740	Radio Jordan	1930 AA	17605	Radio Netherlands	1830
11755	Radio Finland	1630	17625	Radio Bulgaria	1200
11780	Radio Nacional Amazonia, Brazil	0000 PP	17630	Africa Number One, Gabon	1430 FF
11785	Qatar Broadcasting Service	0300 AA	17670	Swiss Radio International	1500
11790	Radio Japan	0100	17740	Radio Finland International	1430
11800	RAI, Italy	0050	17800	Deutsche Welle	1600
11830	Vatican Radio	2250	17810	Radio Japan	2300
11830	Radio Veritas Asia, Philippines	1500	17820	Radio Canada International	1300
11840	Radio Portugal International	0130	17825	UAE Radio	1300
11850	Radio Norway	1600	17870	RAI, Italy	1730 II
11870	Radio Yugoslavia	0430	17895	Qatar Broadcasting Service	1400 AA
11885	UAE Radio, Abu Dhabi	2300	17900	Radio Portugal	2000 PP
11890	Voice of Russia	1500	21605	UAE Radio, Dubai	1600 AA
11895	Radio Japan, via French Guiana	0300			

Satellite View

BY DONALD E. DICKERSON, N9CUE

INSIDE THE WORLD OF SATELLITE COMMUNICATIONS

MIR-2 and Space Station ALPHA

A second step toward a new international space station recently was taken as the world's two greatest space-faring nations participated in another joint manned space mission. The United States' Atlantis (STS-74) and Russian MIR space stations docked for the second of seven joint space missions scheduled through 1997.

The STS-74 crew was commanded by Kenneth Cameron; this was his third shuttle flight to date. James Halsell served as pilot; it was his second flight. Mission specialists included Jerry Ross, William McArthur and Canadian Chris Hadfield.

This was the first mission to include astronauts from Canada, the European Space Agency, Russia and the United States. This will be a typical crew on the proposed international space station "Alpha." The docking and crew transfers with space station MIR will pave the way for the assembly of Alpha beginning in 1997.

Alpha was the interim name given to the redesigned U.S. space station after the Freedom design was abandoned. It is an appropriate name to keep, however, with the truly internationalization of space exploration we have witnessed in recent years.

Atlantis carried the Russian-built docking module, which has multimission docking mechanisms at the top and bottom. During the flight to MIR, the crew used the Orbiter's Remote Manipulator System robot arm to hoist the docking module from the payload and attach it to the shuttle's docking unit, also located in the cargo bay.

Atlantis docked with the Kristall lab of the MIR complex, where it remained for three days. The docking module became a permanent part of the Kristall module; it will provide needed clearance between the shuttle and MIR's solar panels during subsequent dockings.

The international space station will be the pre-eminent, permanent orbiting science lab in space. It is being developed in three phases, each designed to maximize the mission experiments of 13 participating nations.

Phase I saw Americans and Russians working together onboard MIR and the shuttle, including missions STS-60, 63 and 71. Phase II, beginning in 1997, will utilize a new core space station with a U.S. lab as the first working module. Phase III will add modules from various participating countries, scheduled to be complete by 2002.

At present, Phase I establishes a working relationship between the United States, Russia and other international partners.

STS-74 QUICK LOOK

Launch Date/Site: November 1995/KSC Launch Pad 39-A
Launch Time: TBD
Launch Window: Approx. 7 minutes (dependent on planar requirements)
Orbiter: Atlantis (OV-104) - 15th flight
Orbit Altitude/Inclination: 160 nautical miles/51.6 degrees (Docking Altitude, 213 nm)
Mir Docking: TBD
Mir Undocking: TBD
Mission Duration: 7 days, 20 hours, 47 minutes
Landing Date: November 1995
Landing Time: TBD
Primary Landing Site: Kennedy Space Center, FL
Abort Landing Sites: Return to Launch Site - KSC
 Transoceanic Abort Sites - Zaragoza, Spain
 Ben Guerir, Morocco
 Moron, Spain
 Abort-Once Around - KSC

Crew: Ken Cameron, Commander (CDR)
 Jim Halsell, Pilot (PLT)
 Chris Hadfield, Mission Specialist 1 (MS 1)
 Jerry Ross, Mission Specialist 2 (MS 2)
 William McArthur, Mission Specialist 3 (MS 3)

Mir 20 Crew (aboard Mir): Yuri Gidzenko, Commander
 Sergei Avdeyev, Flight Engineer
 Thomas Reiter, Cosmonaut-Researcher (ESA)

EVA Crewmembers (if required): Jerry Ross (EV 1), William McArthur (EV 2)

Cargo Bay Payloads: Docking Module
 Orbiter Docking System
 IMAX Cargo Bay Camera
 GLO

In-Cabin Payloads: SAREX
 DTOs/DSOs

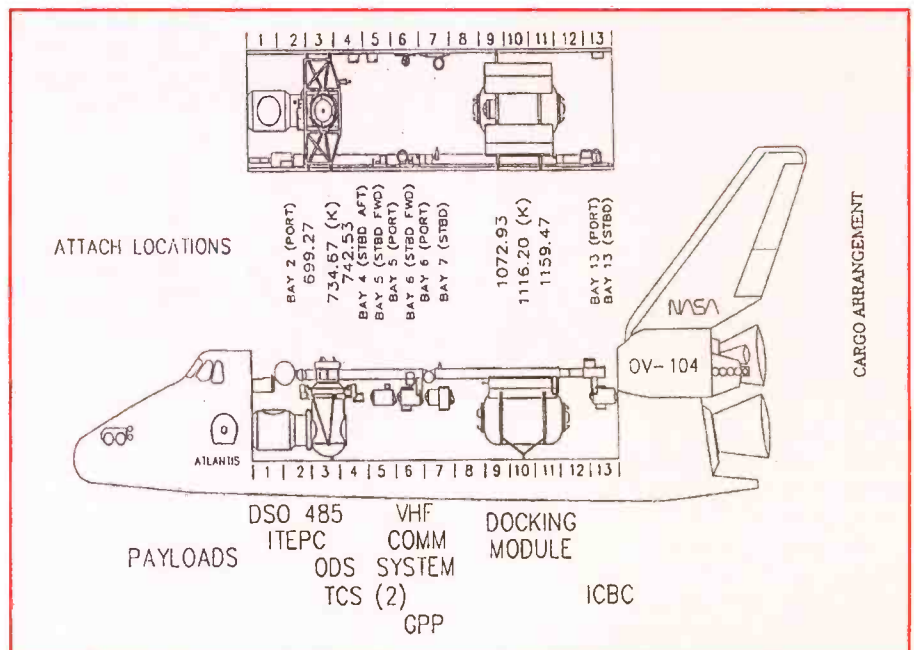

Shuttle Amateur Radio Experiment—II (SAREX-II)

Students in the United States had a chance to speak via amateur radio with astronauts aboard the space shuttle Atlantis during STS-74. Ground-based amateur radio operators contacted the shuttle astronauts through direct voice ham radio links.

Shuttle Commander Ken Cameron, KB5AWP, and mission specialists Jerry Ross, N5SCW, William McArthur, KC5ACR, Chris Hadfield (license pending) and Jim Halsell (license pending) talked to students gathered at five schools in the United States using ham radio.

Students from eight schools in Idaho, Connecticut, Indiana, Illinois and California, had the opportunity to talk directly to orbiting astronauts for four to eight minutes.

The radio contacts were part of the SAREX project, a joint effort by NASA, the American Radio Relay League and the Radio Amateur Satellite Corp. (AMSAT).

The project, which has flown on 19 previous shuttle missions since 1983, is designed to encourage public participation in the space program and support educational initiatives by demonstrating the effectiveness of communications between the shuttle and low-cost ground stations using amateur radio voice and digital techniques.

STS-74 SAREX Frequencies

Because the flight was a shuttle-MIR docking mission, and SAREX and MIR amateur radio stations usually share the

same downlink frequency (145.550 MHz), the SAREX Working Group made the following SAREX frequency change for the STS-74 mission: SAREX transmissions from the shuttle were on a worldwide downlink frequency of 145.840 MHz. The voice uplink frequencies were 144.450 and 144.470 MHz.

The crew used separate receive and transmit frequencies. Amateurs always are cautioned not to transmit on the shuttle's downlink frequency. The uplink is the transmitting frequency for hams. Also, the astronauts do not favor any one of the above frequencies. Therefore, the ability to talk to an astronaut depends on selecting the frequency chosen by the astronaut.

Additional Information

Several audio and digital communication services have been developed to disseminate shuttle and SAREX-specific information during flights. The ARRL's ham station, W1AW, includes SAREX information in its regular voice and teletype bulletins.

The amateur station at the Goddard Space Flight Center, WA3NAN, operates around the clock during missions, providing SAREX information, retransmitting live shuttle air-to-ground audio and retransmitting many SAREX school group contacts.

Shuttle Tracking

Information about orbital elements, contact times, frequencies and crew

operating schedules are available during missions. Keplerian elements to track the shuttle are available from the following sources:

- NASA Spacelink computer information system

- BBS: (205) 895-0028

- Internet, Telnet, FTP, Gopher: spacelink.msfc.nasa.gov

- World Wide Web: <http://spacelink.msfc.nasa.gov>

- NASA SAREX World Wide Web Home Page:

- http://www.nasa.gov/sarex/sarex_mainpage.html

- American Radio Relay League

- Telephone: (860) 594-0301

- BBS: (860) 594-0306

- W1AW news bulletins ("for further information")

- World Wide Web: <http://www.arrl.org>

- AMSAT

- World Wide Web: <http://www.arrl.org>

- NASA Johnson Space Center Amateur Radio Club

- BBS: (713) 244-5625

- Goddard Amateur Radio Club

- BBS: (301) 286-4137

- World Wide Web: <http://garc.gsfc.nasa.gov/www/garc-home-page.html>

- Packet: WA3NAN on 145.090 MHz in the Washington, D.C., area

- The Goddard Space Flight Center Amateur Radio Club uses the following HF frequencies: 3860, 7185, 14295, 21395 and 28650 kHz

Upcoming Shuttle Missions

Mission	Orbiter	Major Payloads	Target Date	Mission Duration
STS-75	Columbia	Tethered Satellite System United States Microgravity Payload-3	February 1996	14+2 Days
STS-76	Atlantis	Shuttle-Mir Mission-3	April 1996	10+1 Days
STS-77	Endeavour	Spacelab-4	May 1996	9 Days
STS-78	Columbia	LMS	July 1996	14+2 Days
STS-79	Atlantis	Shuttle-Mir Mission-4	August 1996	9+1 Days
STS-80	Columbia	Orfeus-Spas WSF	November 1996	16 Days
STS-81	Atlantis	Shuttle-Mir Mission-5	December 1996	9+1 Days

Based on 1995 Manifest

Americans and Russians are working together to integrate long-term American and Russian hardware, systems and goals in science and research. Perhaps the most important work done in this phase is in the area of risk reduction. Safety is a major concern to keep surprises in operations, spacecraft environment, spacewalks or hardware integrity to a minimum.

Phase I of the joint U.S.-Russian space agreement also will impact the MIR space station. This year, MIR will add two additional modules, both built and launched by the United States. MIR, launched in 1986, has four modules attached. Kvant, launched in 1987, has a telescope and altitude controls onboard. Kvant 2, launched in 1989, carries an EVA airlock, solar arrays and scientific equipment. Kristall joined the space complex in 1990. It also carries solar arrays and scientific equipment, though its main purpose was to allow Buran, the Russian shuttle, to dock on the station. Atlantis used this port for the first two MIR missions. A fourth module, Spektr, was added in 1995. It carries solar panels and scientific equipment supplied by the United States. A fifth module to be added this year, the U.S.-equipped Priroda, brings the number of modules in the MIR space complex to seven. When complete, it will have been in orbit for 10 years.

The cooperation and experience accumulated during the MIR completion will be the stepping stone to Phase II and the construction of Alpha base.

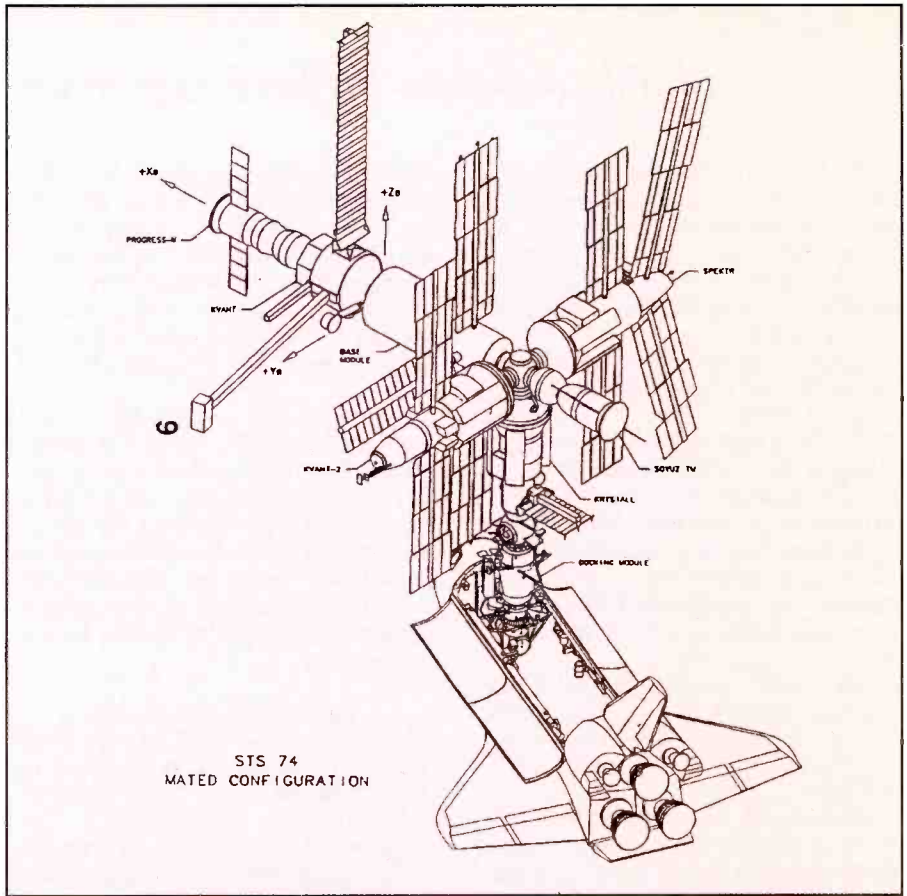

LOOK

HAVE YOU SEEN

U.S. SCANNER NEWS

The **ONLY** National Monthly Magazine Devoted Entirely To the Hobby of VHF-UHF Monitoring. No Shortwave, No Broadcast!!

Each Month You Get:

- Outstanding Feature Articles
- In-Depth, Unbiased Reviews
- The Latest FCC Actions
- Accurate Frequency Information
- Helpful Scanning and Technical Hints
- Plus Regular Monthly Columns

1YR \$20.00; 2YR \$35.00; 3YR \$49.00

Sample \$3.00 1st Class



Mail Check or Money Order or Call **1-800-890-6999**

US SCANNER PUBLICATIONS
 Suite 409, 7276 SW Beav. Hills. Hwy.
 PORTLAND OR 97225
 (503) 203-8600 FAX (503) 203-8631

CIRCLE 76 ON READER SERVICE CARD

YOU AIN'T HEARD NOTHIN'... YET

Since 1967, CRB Research has been the world's leading publisher and supplier of unique hobby and professional books and information including:

- Scanner Frequency Guides
- Shortwave Frequency Guides
- Military/Federal Communications
- Broadcast Station Registries
- Undercover Communications
- Survival Communications
- Covert Operations
- Electronic Espionage
- Surveillance
- & Other Related Topics!

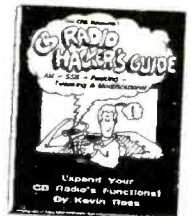

**ASK FOR BIG
FREE CATALOG**

New titles are constantly being added to our exciting catalog. If it's interesting and unusual, we've got it. You'll see. Ask for our latest FREE catalog.

CRB RESEARCH

P.O. Box 56, Commack, NY 11725

Phone: (516) 543-9169

FAX: (516) 543-7486

CIRCLE 11 ON READER SERVICE CARD

Broadcast DXing

BY TIM KRIDEL

DX, NEWS AND VIEWS OF AM AND FM BROADCASTING

Digital Audio Broadcasting Under Way in Europe

Digital audio broadcasting and the chief rival to the U.S. DAB system of choice took a major step forward in Europe with the debut of services in Germany and the United Kingdom. Using the Eureka-147 system, a handful of stations in Bavaria and the five national BBC Radio networks began using DAB in the fall of 1995. Both events are expected to encourage receiver manufacturers to expand production of digital receivers and educate the general public about DAB—and strengthen Eureka-147's position as the worldwide DAB standard.

The Bavarian services—the result of a joint effort between the government of Bavaria, radio stations Antenne Bayern and Bayerischer Rundfunk, receiver manufacturers Grundig and Bosch/Blaupunkt and research and industry groups—include regional programming for Munich and Nurnberg and Antenna Bayern's new rock station.

As the BBC launched its DAB service on Radio 1, 2, 3, 4 and 5, it was looking ahead to the 1996 debut of BBC Now, a continuously updated package of news and information. The BBC hopes that receiver manufacturers will be able to develop radios that can download the information, storing it for use on demand by listeners.

Talk 3, Music 0

Boston talk-radio veteran Gene Burns is the cornerstone of a new, caller-friendly talk format at Framingham, Mass.'s WKOX-AM. "WKOX intends to provide a breath of fresh air in Boston talk radio," program director Scott Gibbons said in a *Middlesex News* article sent to us by WKOX news director Gene Molter. "There will be no more yelling and screaming like at the other stations. We are going to talk to people—not yell at them."

Burns, a DJ on WRKO from 1986 through 1992, "is a talk show host around

whom you can build a great talk radio station," Gibbons said. Callers to his 10 a.m. to 2 p.m. show "will be treated with respect, whether he agrees with them or not."

Other hosts who have been signed up since the station dropped country music in October 1995 include Dr. Laura Schlesinger, Bob Brinker and David Brenner. Red Sox, Celtics, Bruins and Northeastern University games will be carried, as well as football from CBS Radio Sports. Molter notes that WKOX has applied to boost its power from its present 10 kW.

Meanwhile, St. Louis' KATZ-AM has dropped its format of R&B music in favor of talk, giving the city its first and only station with an information format aimed at

blacks. Officials at Noble Broadcasting Group, KATZ's owner, are hoping to achieve the success they've had with their other St. Louis holdings, FMers KMJM and KNJZ, by gearing programming toward a



This photo of the transmitter building of Lincoln, Neb.'s KFOR-AM and KFRX-FM was snapped by Jon Heckman, KBØRXF, of Lincoln.

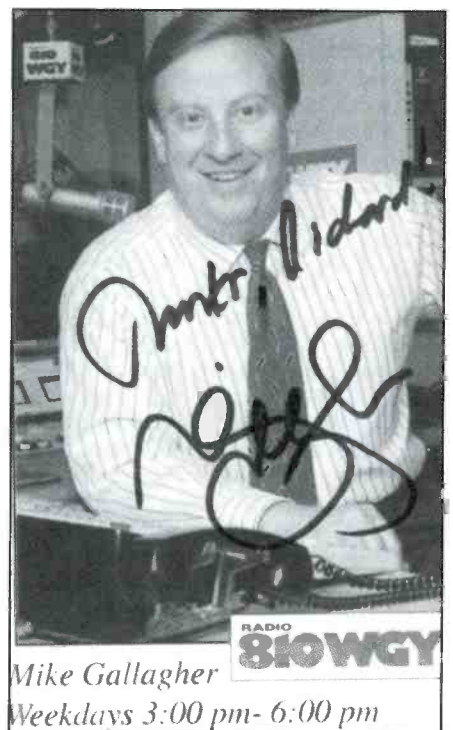

WGYP talk-show host Mike Gallagher autographed this postcard for Richard Klingman of Mount Upton, N.Y. Callers can reach the 50-kW Albany, N.Y., station at (800) TALK-WGY.

black audience. "We cover the urban contemporary music market in St. Louis, and to draw listeners we have to look at the community and 'super-serve' them, not only with music and entertainment, but with news," general manager Steve Mosier told the *St. Louis Post-Dispatch*.

Although the switch taps an underserved niche, the switch from music to talk at the 5-kW, 24-hour station is in keeping with a trend in AM. As Mosier told the *Post-Dispatch*, one of the reasons the station changed its format was because music on AM is dead. While a talk format is itself no guarantee of success, Noble officials insist that KATZ won't be at the mercy of ratings, thanks to its sister stations. "We are not going to get rich off of a 50,000-watt (sic) station with fair reception. We operate the only urban contemporary station (KMJM) in St. Louis, and with the advertising base it has established along with KNJZ, we will be able to steadily operate KATZ." Still, station officials are optimistic about the new programming, pointing to the success of similar formats at Washington, D.C.'s WOL-AM and New York City's WLIB-AM.

Finally, Beverly Hills, Calif.'s KJQI-AM has dropped adult standards and KJQI for all-news and KNNS, according to a Los Angeles *Daily News* article sent by Michael Carland of Valencia, Calif. Programming includes local newscasts and syndicated news from The Associated Press and Bloomberg.

Payback?

Howard Stern's snipes at the owners of his former Chicago affiliate, and a subsequent advertiser boycott allegedly orchestrated by them, apparently have caused the shock jock to be bounced from WCKG-FM. Stern had been dropped from Evergreen Media's WLUP-FM in 1993 for what company officials said were poor ratings, and he apparently returned the favor in March 1995 from the safety of competitor and new affiliate WCKG by making remarks about two Evergreen executives and their families. But according to a report in *Broadcasting & Cable*, Evergreen wasn't about to turn the other cheek—their Chicago stations allegedly organized an advertiser boycott, which may have contributed to WCKG's decision to drop his show in early October. Stern wasn't without a home for long, however—WJJD-AM, owned by his syndicator, Infinity Broadcasting, picked up the show the next day.

Stern also drew fire last year from the National Hispanic Media Coalition for his remarks about the late pop singer Selena. His comments, which the group describes as going "far beyond the boundaries of contemporary community standards," caused the group to file and convince the FCC to revoke the license of Stern's Los Angeles affiliate, KLSX. Using his show as an exam-

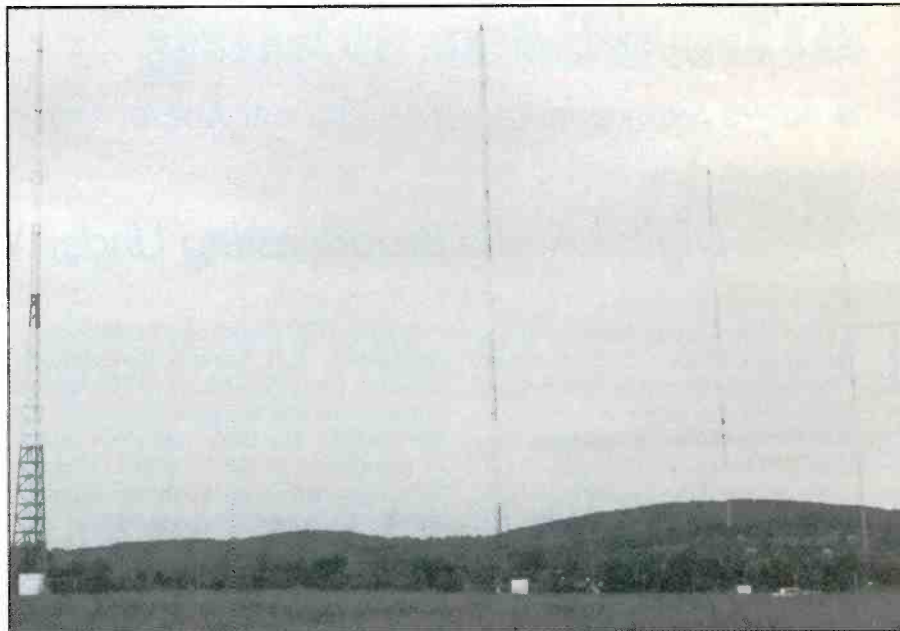

These four "sticks" belong to Frederick, Md.'s WFMD-AM and WFRE-FM. (Courtesy James H. Young, Springfield, Va.)

ple of what it describes as "rampant indecency," the group said in its filing that "the revocation of KLSX's license is the least that the FCC can do to restore some semblance of substance to the 'public interest' standard."

Where to Start?

Last month, we discussed what to consider when choosing a receiver. Naturally,

any radio is only as good as the antenna it's attached to. There are many types—home-made and manufactured, active and passive—to choose from, but again, the decision is based on what you want to hear and what hurdles are in the way. For example, if you're interested in AM DX and you have a couple of acres of open land, a beverage antenna might be your choice. Don't despair if you haven't got the room to string out a few thousand feet of wire—as little as

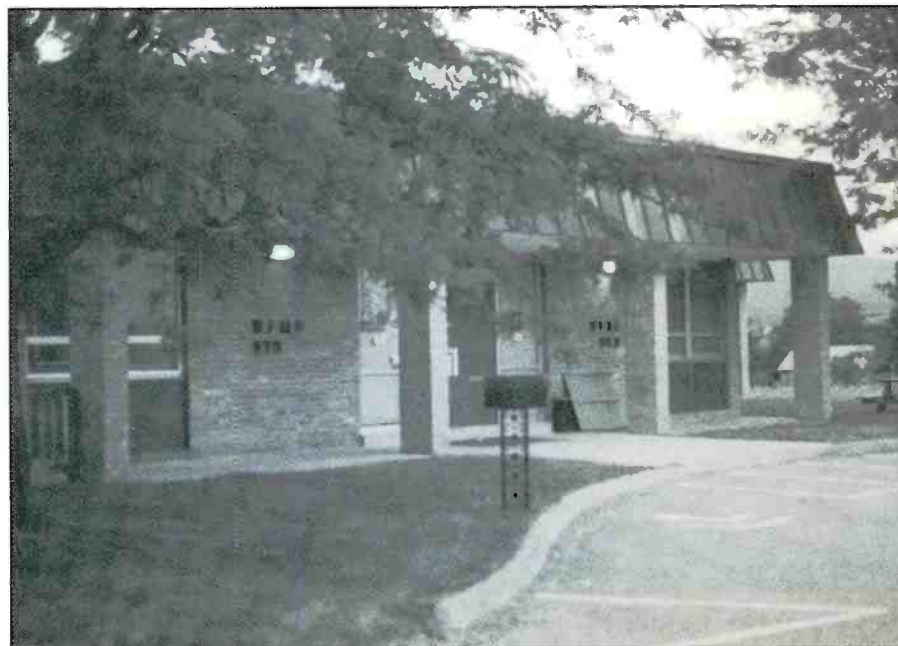

The facilities of WFMD and WFRE. (Courtesy James H. Young.)

Applied for Permit to Construct New AM Station

TX	Bellaire	1560 kHz	500 watts (KGUL booster)
----	----------	----------	--------------------------

Permits Granted to Construct New AM Stations

AK	St. Paul	540 kHz	2.5 kW
NM	Farmington	1610 kHz	1 kW (experimental)
TN	Bluff City	1680 kHz	400 watts (experimental)

Applied for Permits to Construct New FM Stations

AK	Fairbanks	96.9 MHz	
CA	Needles	107.1 MHz	50 kW
CA	Rancho Bernardo	106.5 MHz	4 watts (KKLE booster)
CA	Santa Cruz	90.7 MHz	320 watts
FL	Homestead	90.9 MHz	3 kW
FL	Indian River Shores	97.1 MHz	6 kW
GA	Savannah	88.1 MHz	12 kW
IL	Albion	91.7 MHz	6 kW
IL	Mount Vernon	98.7 MHz	6.2 kW
LA	St. Martinsville	89.9 MHz	100 kW
MN	Buhl	92.5 MHz	39 kW
MT	Cut Bank	102.7 MHz	100 kW
ND	Harwood	100.7 MHz	25 kW
NE	Kimball	100.1 MHz	6 kW
NH	Lancaster	102.3 MHz	360 watts
NY	Ogdensburg	98.7 MHz	3 kW
OK	Sulphur	89.3 MHz	1 kW
OR	Klamath Falls	104.7 MHz	
OR	Milton-Freewater	88.5 MHz	5 kW
PA	McConnellsville	88.7 MHz	100 watts
PA	South Waverly	96.1 MHz	
PR	Santa Isabel	98.1 MHz	52 kW
TN	Dickson	91.5 MHz	6 kW
VA	Bristol	90.7 MHz	500 watts
WA	Davenport	97.3 MHz	4.8 kW
WV	Buffalo	92.9 MHz	(KLAT booster)
WY	Diamondville	105.3 MHz	50 kW

Permits Granted to Construct New FM Stations

AL	Andalusia	91.5 MHz	5 kW
AR	Pine Bluff	91.1 MHz	1 kW
IN	Anderson	89.5 MHz	400 watts
KS	Fredonia	104.1 MHz	6 kW
MI	Lake City	104.9 MHz	4.6 kW
MI	Tawas City	103.1 MHz	6 kW
MN	Babbitt	106.7 MHz	19.8 kW
MT	Kalispell	89.9 MHz	850 watts
ND	Cavalier	105.1 MHz	44 kW
ND	Devils Lake	96.7 MHz	45 kW
ND	Rugby	95.3 MHz	6 kW
SC	Kingtree	94.1 MHz	6 kW
TN	Tusculum	103.1 MHz	6 kW
TX	Dimmit	100.5 MHz	25 kW
WY	Ethete	89.5 MHz	100 kW

Canceled

KOPE-FM1	Grants Pass, OR	103.5	(booster only)
KXRC	Clarendon, AR	107.3 MHz	3 kW

50 or so feet of wire still will do nicely, even when it's indoors, tacked around the edges of your ceiling.

Much more compact—but very sensitive, nonetheless—is the loop antenna, which comes in various sizes and designs.

Loops are especially useful to mediumwave DXers because they're highly directional and thus allow you to "null out" offending stations—for example, a strong semi-local station that's blocking the distant, lower-powered station you want to hear.

SURVEILLANCE

FM TRANSMITTERS MINI (KITS)

- 3-VOLT FM XMTR, up to 300 ft. indoors, 1500 ft. outdoors
- PHONE XMTR, range to 500 ft., uses phone-line power
- Sound-Activated XMTR, range to 500 ft.
- 2-STAGE XMTR, 9-Volt, very powerful

All above require simple soldering at 2 to 4 places. **\$29.95** ea.**

TELE FM WIRELESS MONITORING SYSTEM. (Kit) **\$99.00***

TELE CALL FORWARDER. Transfers incoming calls. **\$99.00***

CALLER ID. Registers incoming number. **\$99.00***

TEL REGISTER WITH PRINTER. Records dialed number, duration, and prints record. **\$139.00***

12-HOUR LONG-PLAY RECORDER. Modified Panasonic. Records 6 hrs. on each side of 120 tape (supplied). Compatible with VOX and Tel Rec Adapter. **\$119.00***

VOX VOICE-ACTIVATED SWITCH. Makes recorder self-activating with voices or other sounds. **\$28.50****

TELE RECORDING ADAPTER. Records incoming and outgoing calls. **\$28.50****

TELEPHONE SCRAMBLERS. Over 4,000 separate codes. **\$199.00***

VOICE CHANGER. Changes man's voice to lady's and vice versa. **\$49.00***

For Shipping & Handling add *\$5.00 and **\$2.00 per item. Colo. residents add sales tax. Mail Order, VISA, M/C, COD's o.k. Inquire for dealer prices. Free catalog.

MUCH, MUCH MORE — OUR 26TH YEAR!

TOLL FREE 1-800-926-2488

A.M.C. SALES, INC.

193 Vaquero Dr., Boulder, CO 80303
Tel: (303) 499-5405, Fax: (303) 494-4924
Mon.-Fri. 8 a.m.-5 p.m. Mtn. Time

CIRCLE 51 ON READER SERVICE CARD

NEW! ONLY \$99⁹⁷
High performance, full featured PC scanning on Windows™ or Windows 95!

Scan*Star SE Edition for Windows:

- o Spectrum analysis & printing on selected receivers.
- o AR8000 auto-unblock and band plan edit.
- o Scan, search and log by PL/DPL.
- o Mini status display for minimum desktop footprint.
- o Full featured editor, all settings are per-channel.
- o Highest performance Windows scanning.
- o Log air time, hit count, PL/DPL/DTMF per channel.
- o Browse & Import from DBASE files, Grove or Percon.
- o Blend up to 25 groups and search ranges.
- o Tactical display for all-in-view picture.
- o Import & export data to and from other formats.
- o Much more!

Scan*Star Plus for Windows - SE features plus:

- o User defined database fields.
- o Search-slave handoff with priority & preemption.
- o Sub list scans for split channels and trunk groups.
- o Scan with up to 10 radios at the same time.
- o Monitoring assistant with frequency following.

Equipment Supported:

OS456, OS535, R7100, R7000, R9000, FRG9600, DC440, AR3000, AR8000, NRD535, NRD525, R8, R8A.

System Requirements:

IBM PC 386/486/586 with 4 MEG ram, hard disk, VGA, mouse, serial ports. Windows 3.1 or 95. Cables and interfaces for radios may also be required.

Scan*Star Plus [Windows] \$159⁹⁷
Scan*Star SE [Windows] \$ 99⁹⁷
Commercial Edition [DOS] \$129⁹⁷

Add S/H & TAX. Visa, MC, AMEX cards accepted. No COD.

1-408-926-5630

Signal Intelligence
The Leader in PC
Radio Scanning
PO BOX 640891
San Jose CA 95164

FREE DEMO
Download from Scan*Star BBS
1-408-258-6462
URL: <http://www.scanstar.com>

CIRCLE 73 ON READER SERVICE CARD

Applied to Modify AM Facilities

KFIA	Carmichael, CA	710 kHz	Seeks 25/1 kW power.
KGME	Glendale, AZ	1360 kHz	Seeks increase to 50 kW.
KOKE	Giddings, TX	1600 kHz	Seeks move to Pflugerville, 5 kW/500 watts.
WJIM	Lansing, MI	1240 kHz	Seeks drop to 890 watts.
WMMO	Eden, NC	830 kHz	Seeks move to Kernersville; 10 kW nights.
WXLX	Newark, NJ	620 kHz	Seeks move to Jersey City instead of Rutherford.

Changed AM Facilities

KARS	Belen, NM	860 kHz	Increased days to 1 kW.
KENM	Saipan, CM	1053 kHz	Moved to 1080 kHz, 5 kW.
KJJX	Fergus Falls, MN	1090 kHz	Moved to 1020 kHz, 2/1 kW.
WJGG	Elmhurst, IL	1530 kHz	Increased to 760 watts.
WMTY	Greenwood, SC	1090 kHz	Increased days to 5 kW.
WNDZ	Portage, IN	750 kHz	Increased days to 17 kW.

Applied to Change FM Frequency

WGMT	Lyndon, VT	98.3 MHz	Seeks 98.9 MHz.
------	------------	----------	-----------------

Changed FM Frequencies

WDUV	Bradenton, FL	103.3 MHz	Moved to 103.5 MHz, 99 kW.
WGMX	Dayton, OH	98.1 MHz	Moved to 98.9 MHz.

Changed AM Call Letters

New	Was		
KAYD	KAYC	Beaumont, TX	
KNRQ	KZZK	Springfield, OR	
KNWX	KRPM	Seattle, WA	(770 kHz)
KRPM	KNWX	Seattle, WA	(1090 kHz)
KWFT	KNON	Wichita Falls, TX	
KWSL	KKSC	Sioux City, IA	
WAUX	WMIR	Lake Geneva, WI	
WCYK	WCNF	Crozet, VA	
WDCD	WPTR	Albany, NY	
WISZ	WBYY	Rockford, MI	
WKIK	WSMD	La Plata, MD	
WKPP	WITM	Elizabethton, TN	
WMFN	WISZ	Zeeland, MI	
WNWN	WHEZ	Portage, MI	
WZZQ	WBFX	Terre Haute, IN	

Beginning FM DXers shouldn't overlook the antennas they already may have in place—if you're a scanner buff, you can achieve great results on FM by using an omnidirectional, wide-spectrum discone. Another option is an outdoor TV antenna—because most manufacturers optimize the antenna for both TV and FM—and using a remote-controlled antenna rotator to position the antenna for optimum reception.

As with AM, having the antenna indoors doesn't necessarily doom you to the DX doldrums. Something as simple as putting the antenna near a window or in an attic can make a difference. In both AM and FM, active antennas are useful if an outdoor installation isn't possible, but bear in mind that they can amplify noise and unwanted interference along with the signal. And no matter what antenna you use, always keep it and yourself away from power lines. Not only can electricity kill, it also can introduce unwanted noise.

For many DXers, the next step after hearing a station is obtaining proof of their feat. "QSL"—a term adopted from amateur radio—means to acknowledge or confirm reception. What constitutes a QSL depends on who you ask—a diehard might say that it must formally state that you did indeed hear the station, while other hobbyists are satisfied with having their original reception report returned with "Thanks for your letter" and a signature scrawled at the bottom. A QSL can take the form of a card or letter, or sometimes both.

How do you get a QSL? Half the battle is writing an accurate, detailed report. For example, don't describe the programming simply as "country music, ads and DJ chatter." When possible, include the names of the announcer(s), businesses advertised and maybe a song or show title, along with the time when you heard them aired. Doing so makes it much easier for station personnel to recognize immediately that it's

their station being described. Accuracy counts, which is why next month we'll take a look at a trick you can use to write a correct, detailed report. Most DXers also include the reception conditions and type of receiver and antenna used. Finally, always include return postage or a self-addressed, stamped envelope.

Sadly, no matter how accurate and courteous you are, there's no guarantee that you'll get a response of any kind. Some stations simply don't verify, even after repeated requests, usually because of a lack of time or a dim view of DXers as annoying eccentrics. On the other hand, some stations will reward you not only with a QSL, but also bumper stickers, key chains, T-shirts and hats.

In Brief

•Canada has imported some classic American radio shows for CBC Radio's Saturday evening series, "The Mystery

New FM Call Letters Issued

KBAL-FM	San Saba, TX
KCGX	Broken Bow, OK
KMLW	Moses Lake, WI
KRMB	Bisbee, AZ
KULU	Seaside, OR
WAAE	Fisher, WV
WJRC	Lewistown, PA
WOXM	Oregon, IL
WSTF	Andalusia, AL

Pending FM Call Letter Change

New	Old	
WNCE-FM	WCTX	Palmyra, PA

Changed FM Call Letters

New	Was	
KAMX	KPTY	Luling, TX
KAYD-FM	KAYD	Beaumont, TX
KCBZ	KAMF	Canyon Beach, OR
KCJC	KWKK	Dardenella, AR
KDAA	KQMX	Rolla, MO

KGEM-FM	KAFN	Hanford, CA
KGHO	KJET-FM	Hoquiam, WA
KNRQ-FM	KZZK-FM	Creswell, OR
KNWB	KFSH	Hilo, HI
KRNB	KSTV-FM	Decatur, TX
KRXZ	KRDM	Ardmore, OK
KSKZ	KWKR	Leoti, KS
KTAC	KTBI-FM	Ephrata, WA
KTFX	KTOW-FM	Sand Springs, OK
KVEZ	KMDX	Parker, AZ
KWKK	KOJC	Russellville, AR
WCVU	WMMY	Solana, FL
WEZY	WHKQ	Racine, WI
WIHC	WUFQ	Newberry, MI
WIIZ	WAAN	Blackville, SC
WNRQ	WXRB	Pittsburgh, PA
WNWN-FM	WNWN	Coldwater, MI
WOFX	WPPT	Cincinnati, OH
WSOL-FM	WHJX-FM	Brunswick, GA
WVAE	WOFX	Fairfield, OH
WWSF	WXCR	Andalusia, AL
WXEG	WRVF	Beavercreek, OH
WZZQ-FM	WZZQ	Terre Haute, IN

Project." Detective shows from the 1930s, '40s and '50s—among them *Night Beat*, *The Saint*, *Suspense* and *The Adventures of Nero Wolfe*—were featured last fall as *The Mystery Classics*. A major reason U.S. shows were chosen was that 20 episodes could be purchased for what it would cost to produce a single live program, executive producer Bill Howell said in a Saskatoon *Star Phoenix* article sent to us by Trevor Fletcher of Edmonton, Alberta.

•Reasoning that "automation is seen as affording more accurate and controlled operation than that performed by humans," the FCC has waived its rules to allow unattended operation of stations. The National Association of Broadcasters praised the move as "a real win-win for broadcasters. For a small-market, small-staff radio station, this is a big deal." The commission also eliminated the requirement that station operators hold a restricted radiotelephone operator's permit.

•Demand for copper is suspected as the motive that led vandals to cut the guy wires to one of the antenna towers for Sacramento, Calif.'s KCTC-AM, sending it crashing into the adjacent tower that held the antenna for sister station KYMX-FM. Although KCTC emerged from the Sept. 6 incident unscathed, "Mix 96" was off the air for more than six hours before station personnel were able to rig up a temporary antenna, reports *Radio World*. A station official estimated the total damages at \$375,000, adding that "nothing was salvageable."

•An ad spotted in the personals section of a couple of Chicago newspapers: "Established but aimless FMer seeks proven format for long-term relationship. Must be music-oriented and financially stable. Serious replies only to 190 N. State St." No,

not really, but the owners of WLS-FM might as well give it a try. CapCities/ABC execs reportedly are mulling over yet another format change for their Chicago holding—this time contemporary or country music. WLS-FM resumed simulcasting WLS-AM's talk format after a brief, unsuccessful flirtation with a younger talk audience last year, but *Broadcasting & Cable*

reports that CapCities/ABC officials still are searching for a format of its own. No word at presstime as to when the change might be made.

Thanks

News clippings, station and shack photos, bumper stickers and QSLs always are welcome, as are questions and comments.



+30db

MADE IN USA

The Original **Select-A-Tenna** ★★★★★

- AM RADIO ANTENNA WORKS WITH THE BUILT-IN ANTENNA IN YOUR RADIO
- NO WIRES TO CONNECT
- NO BATTERIES
- HIGH-Q SUPER GAIN AND SELECTIVITY
- PROVEN WORLD-WIDE FOR OVER 22 YRS
- SATISFACTION GUARANTEED
- THIS ONE REALLY WORKS!

\$59.95 PLUS SHIPPING

TOLL-FREE
1-800-382-4155
FAX
1-317-883-7555

INTENSITRONICS CORP.
P.O. BOX 562 DEPT. Q
HALES CORNERS, WISC. 53130

CIRCLE 162 ON READER SERVICE CARD

PROFESSIONAL 10 HOUR RECORDER. Built like a BATTLESHIP



- * Special *Pop Comm* price \$149
- * Heavy Duty commercial recorder (NOT "improvised" from a consumer model)
- * Full one year warranty * Dimensions 11.5 x 7 x 2.75"
- * BUILT-IN voice activation: add \$25
- * Also available: 12, 14 and 16 hour models
- * Recorders come with full applications info for scanners, etc.

FREE

32 Page
Special Equipment
Catalog



VIKING INTERNATIONAL

150 EXECUTIVE PARK BLVD. #4600
SAN FRANCISCO, CA 94134
PHONE: (415) 468-2066 FAX: (415) 468-2067

SINCE 1971

No shipping charges on prepaid orders (48 states). COD's OK.
Cal. residents add tax. Sorry, no credit cards (all they "do" is increase prices...)

CIRCLE 163 ON READER SERVICE CARD

Communications Confidential

YOUR GUIDE TO SHORTWAVE "UTILITY" STATIONS

Several readers are asking for information on the Icom R71A modification mentioned in a past column. Donald Tomkinson, CA, had written explaining when he modified his R71A, the memory channels increased to 1088. Donald obtained the mod kit from Willco Electronics, P.O. Box 788, New Lenox, IL 60451.

Tom Severt, KS, reports P7X was heard every night from about 2300-0400 for two weeks on 5431.5 kHz. The standard 120 group messages were sent interspersed with data transmissions.

Bunky, IL, writes, "I recently began hearing a group of seemingly high power FSK stations in the LF aero beacon band. These stations are running 200-250 baud with an approximate 85 Hz shift and sound

like the VLF naval stations (NAA, etc.). The frequencies are 297, 310, 311, 317, 319 and 322 kHz. Any idea what these are or why they are in this band?"

I haven't identified these transmissions. When I checked the frequencies only 297 and 322 kHz were active. Can anyone shed any light on these signals?

In answer to several queries, the following explains confusion regarding a FEMA station in Winchester, Va.

About five years ago, Perry Crabill, Jr., Virginia, advised me that beacon XPZ on 265 kHz was incorrectly listed, with coordinates placing it at the old Post Office building in Winchester, Va.

Following a hunch, Perry drove to the vicinity of Mt. Weather, Va., a federal relocation site commonly called the FEMA

Special Facility. When Perry arrived opposite the site's heliport, he could hear the second harmonic (530 kHz) of the XPZ beacon on his car radio and could see the beacon station's vertical antenna inside the chain-link fence surrounding the federal property.

I have seen information indicating there is a FEMA backup command center located at Laytonsville, Md., near Olney, Md. Could this be the site assigned callsign WGY913?

I will continue checking into this, and will share any additional details.

It is interesting how many responsibilities and functions other agencies and departments transferred to FEMA over the years. Note the following list:

From HUD—Federal Disaster Assis-

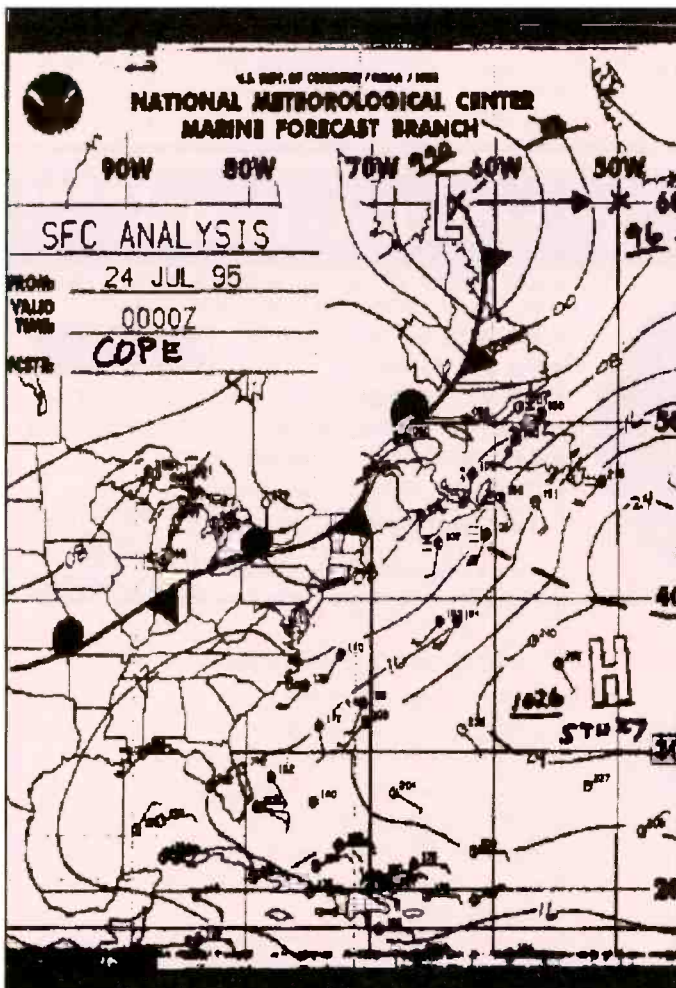

Sue Wilden, IN, copied this fax with her Sangean ATS-803A connected to a diode antenna. An u/i decoder was used.

P V	387
BEACON	KHZ
This will verify your reception of our beacon.	
Date: <u>November 11, 1994</u>	Verified By: _____
Freq: <u>387 KHZ</u>	Title: <u>Roy Young</u>
Time: <u>0529 UTC</u>	Date: <u>RADIO ENG PROG</u>
Elevation: <u>feet</u>	Date: <u>20-2-95</u>
Power: <u>250 Watts</u>	Remarks: _____
Location: <u>2147N 1216W</u>	<u>Turks and Caicos Islands</u>
Antenna Type: <u>T</u>	
<u>Providenciales</u>	

Beacon reception PFC used by Allen Renner, PA.

VERIFICATION OF RECEPTION			
DOOM 81			
Date	Time (UTC)	Frequency	Mode
12 July 1994	0350	11176	USB
Aircraft Type	Approx. Xmsn Location	Aircraft Registr #	
B-52H	25 NM FROM 12174 ENTRY	60-0059	
Aircraft Home Base			
BARKSDALE AFB LA			
94 th Bomb Squadron			
Signature	<u>[Signature]</u>	CAPT USAF	Official Stamp

PFC used by Steve McDonald, British Columbia, Canada for verification of his monitoring of comms from a B-52H aircraft. See accompanying letter.

tance Administration and the Federal Flood Insurance Program.

From DOD—Defense Civil Preparedness Agency.

From Commerce—National Fire Prevention and Control Administration and the Emergency Broadcast System.

From GSA—Federal Preparedness Agency.

From the Office of Science and Technology Policy—Earthquake Hazards Reduction Office.

A recent Associated Press item reported the decommissioning of the bunker located under the Greenbrier resort in West Virginia in July 1995. Area locals remember the bunker's construction in the late 1950s.

In the event of a nuclear war, Mount Weather was to be the relocation site for the president, justices of the Supreme Court, cabinet secretaries and other high-ranking officials. Greenbrier, on the other hand, was for the members of Congress, family and staff.

In May 1992, *The Washington Post* blew any remaining efforts in concealing the installation when it published a lengthy article describing the Greenbrier facility and other federal relocation sites.

Greenbrier was used earlier during World War II when Japanese diplomats interned there.

Readers often question a sweeping signal heard while monitoring. One reader reported tracking the signal from the 5 MHz band, up into the 20 MHz band. I suspect this was a Chirpsounder transmission. This equipment transmits a signal and listens to it, thus checking the quality of radio propagation in the 2-30 MHz range. This provides an indication of frequencies that can be used for reliable communications for a particular link.

Here is an update of some information reported here last month. The JCS code-name for the National Emergency Airborne Command Post (NEACP) activity is Night Watch. Please note that it is two words and not Nightwatch as previously reported.

Simon Mason, England, reports RAF Chicksands finally has closed down. When Simon recently passed by the base, all the houses were vacant and the main gate was cordoned off.

Simon also reports unusual Mossad activity on 14750 kHz at 1100. MIW callup was followed by Message, Message Group 12 and into 5L groups. Then announced "End of Message," "End of Transmission," but said MIW again. Immediately sent the same message again. This same routine was reported until 1800. Also heard on 17170 and 20425 kHz. At 1800 same Group 12 message sent on 6658 kHz, all evening and night continuously until 0800 when transmission was back on 14750/17170/20425 kHz. The message was re-

24 AUG 94

Dear Steve,

Your information on Doom 81 was right on the money. After receiving your letter I went and researched the paper work from Doom 81's flight. They aborted entry into IR 174 because of bad weather. It is good to hear that the signal strength was extremely good, because we have very powerful transmitters on the B-52.

Unfortunately, we do not have any official stamping here at the 96th Bomb Squadron. Instead I am enclosing a squadron patch. I hope this is good enough for your verification.

Good luck with your hobby and best wishes from the 96th BS!

Sincerely,

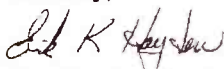

Capt Erik K. Hayden
B-52 Pilot, USAF

ported until 1115 when MIW2 was sent, broadcast, then terminated. This was a continuous 24-hour broadcast of the same message.

Rick Baker, OH, advises that USCG CAMSPAC San Francisco callsign NMC has changed its name to CAMSPAC Point Reyes.

**UTE Loggings:
SSB/CW/SITOR/etc.**

All times in UTC

198: Beacon DIW, Dixon, NC, at 2215. (DS)

201: Beacon DED, Deland, FL, at 0100. (WP)

206: Beacon GLS, Galveston, TX, at 0130. (WP)

208: Beacon JYN, Goldsboro, NC, at 2216. (DS)

216: Beacon CLB, Wilmington, NC, at 2217. (DS)

223: Beacon YYW, Armstrong, Ont., Canada, 1041m at 0654. (AH)

234: Beacon RYD, Green Cove Springs, FL at 0130. (WP)

235: Beacon RW, Rocky Mount/Wilson, NC, at 2218. (DS)

242: Beacon EFK, Newport, VT, 242m, hrd at 0616. (AH)

245: Beacon NKT, Cherry Point MCAS, NC, at 2139. (DS); Beacon AN, NAS North Island, CA at 1815. (DT)

263: Beacon DA, Daytona Intl Airport, FL at 0130. (WP)



QSL card from the collection of Ed Rausch, NJ.

Abbreviations Used For Intercepts

AM	Amplitude Modulation mode
BC	Broadcast
CW	Morse Code mode
EE	English
GG	German
ID	Identification/led/location
LSB	Lower Sideband mode
OM	Male operator
PP	Portuguese
SS	Spanish
tfc	Traffic
USB	Upper Sideband mode
w/	With
wx	Weather report/forecast
YL	Female operator
4F	4-figure coded groups (i.e. 5739)
5F	5-figure coded groups
5L	5-letter coded groups (i.e. IGRXJ)

- 260: Beacon YT, St. Johns, Nfld, Canada, 999m, hrd 0615. (AH)
- 276: Beacon FPR, Fort Pierce, FL, at 0225. (WP)
- 280: Beacon MQW, McRae, GA, at 0325. (RH2)
- 282: Beacon GWF, Fox Airport, CA, at 1155. (DT)
- 284: Beacon PTB, Petersburg, VA, 453m, hrd 0826. (AH)
- 290: Beacon YNP, Managua, Nicaragua at 0541. (RH2); Beacon YYF, Penticton, BC, Canada, at 1110. (DT); Beacon Y Yanketown, FL, (Marine) at 0200. (WP)
- 294: Beacon ZIP7 Zipaquirá, Colombia, 2529m, at 0727. (AH)
- 300: Beacon LAP, La Paz, BC, Mexico, at 0825. (DT)
- 302: Ex-beacon L, Pt. Loma, CA, 24hrs DGPS. (DT)
- 305: Beacon DZM, Dumas, AR at 0314. (RH2)
- 311: Beacon TBG, Panama City, Panama at 0125. (RH2)
- 323: Beacon EB, Webster City, IA, at 0115. (RH2)
- 326: Beacon PKZ, Pensacola, FL, at 0030. (WP)
- 329: Beacon ISM, Kissimmee, FL, at 0320. (WP)
- 332: Beacon FIS, Key West, FL, at 1015. (RH2)
- 335: Beacon LEE, Leesburg, FL, at 0200. (WP)
- 336: Beacon PV, Atlantic City, NJ, 227m, at 1416. (AH)
- 341: Beacon YYU, Kapuskasing, Ont., Canada, 765m, at 0743. (AH)
- 344: Beacon DPL, Kenansville, NC, at 2332. (DS)
- 350: Beacon LE, Raleigh/Durham, NC, at 2145. (DS)
- 353: Beacon LLD, Lanai Island, HI at 0850; Beacon ZES, Cape Scott, Vancouver, Canada, at 0820. (DT); Beacon JUK, Brunswick, GA at 0130. (WP)
- 355: Beacon MKS, Moncks Corner, SC, (St. Simon's Island). (WP)
- 360: Beacon LYS, Lyndon, NY, 366m, at 0900. (AH)
- 363: Beacon RNB, Milville, NJ, at 0251. (RH2); Beacon D3, Ponoka, Alberta, Canada, at 1052. (RG)
- 365: Beacon CKK, Miami, FL, at 0143. (RH2); Beacon FT, Ft. Worth, TX at 0820. (DT)
- 367: Beacon HA, Hao Atoll, French Polynesia, at 0825. (DT)
- 368: Beacon ZP, Moresby Island, Canada at 1235. (DT)
- 372: Beacon CQD, Erie, PA, at 2357. (RH2)
- 373: Beacon EP, Estevan Pt., BC, Canada, at 1230. (DT)
- 375: Beacon JRV, Morrisville, VT, 220m, at 0739. (AH)
- 376: Beacon LC, Columbus, OH at 0133. (RH2)
- 377: Beacon YRR, Ottawa, Ontario, Canada at 0650. (AH)
- 379: Beacon BRA, Asheville, NC, 743m, at 0853; Beacon IVV, White River, VT, 151m, at 0100. (AH)
- 382: Beacon VCY, Valley City, ND at 0311. Beacon MLR, Millersburg, OH at 1011. (RH2)
- 383: Beacon PI, Pocatello, ID at 0830. (DT); Beacon D9, Huntsville, Ontario, Canada, at 0142. (RH2)

All FF stations within France have callsigns beginning with RFF while overseas stations begin with RF. The basic callsign for Reunion is RFVI but there are several combinations of additional letters as the following recent naval signal in ARQ E 96/428 shows:

RR RFVTT (to FN Reunion)
 DE RFFLVM (from FN Toulon)
 ZNR UUUUU
 FM UGECOMAMEC TOULON
 TO RFVTT/LA BOUDEUSE
 INFO RFFLA/MARINE TRANSIT LE BOURGET
 RFFINDUALINDIEN
 RFFVC/MARINE LA REUNION
 RFQPMJVN/JULES VERNE (Jibouti - naval ship)
 RFFVITZ/COMSUP ST DENIS REUNION
 RFFVICPL/CHAMPLAIN (naval ship)
 RFFVIALB/ALBATROS (" ")
 then message text in FF & 5Lgps
 NNNN

Reunion comms cover not only the Indian Ocean but also relays for the Far East and Antarctica; thus the island must be one of the most important communications centres in the world for the French (along with Jibouti - which is not part of France - and covers the Middle East) The above signal was taken on 14731.7 khz but there are many more Reunion frequencies, and also many more RFVI+++ callsigns!

This fact sheet on Reunion Island was prepared by Robert Hall, South Africa. The island is located in the Indian Ocean about 500 miles to the East of Madagascar. It provides an excellent base for French military and naval forces. Some of the communications modes utilized by these forces include RTTY, ARQ-E, ARQ-E3, and ARQ-M2.

- 386: Beacon GMA, Dalton, NH, 196m, at 0133. (AH)
- 388: Beacon H7, Manitowaning, Ontario, Canada, 604m, at 0759; Beacon RNW, Chocowinity, NC, 521m, at 0449. (AH); Beacon OCQ, Oconto, WI at 0237. (RH2)
- 391: Beacon DDP, San Juan, PR at 0155. (DS); Beacon EBY, Neah Bay, WA at 0655. (DT)
- 392: Beacon VEP, Vero Beach, FL at 0215. (RH2)
- 395: Beacon XEN, Xenia, OH, 676m, at 0854. (AH)
- 397: Beacon LLJ, Challis, ID, at 1225. (DT)
- 400: Beacon G, Charlottetown, PEI, Canada, 524m, at 0825. (AH)
- 401: Beacon IS, Kinston, NC, at 2322. (DS)
- 404: Beacon MOG, Yreka, CA at 0730. (DT)
- 405: Beacon AKT, Appleton, WI, at 0224. (RH2)
- 407: Beacon YHD, Dryden, Ont., Canada, at 0245. (RH2); Beacon ISSJ, Wiscasset, ME, 188m, at 0833. (AH)
- 412: Beacon CTZ, Clinton, NC, at 2153. (DS)
- 413: Beacon OEG, Eagle, AZ, at 1245. (DT); Beacon TAM, Tampico, Mexico, 2036m, at 0718. (AH)
- 414: Beacon SUE, Sturgeon Bay, WI, at 0144. (RH2)
- 415: Beacon CBC, Cayman Brac, BWI, at 0144. (RH2)
- 417: Beacon HQT, Coats, NC, at 2155. (DS)

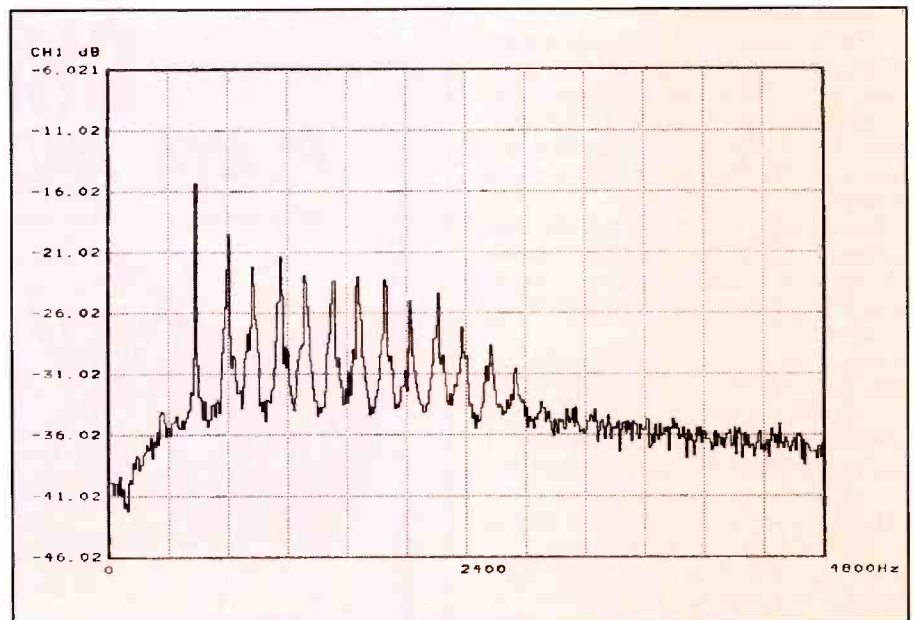

Kevin Tubbs, VT, prepared this analysis chart. It shows a VFT-f08b system in USB on 4083 kHz.

424: Beacon RVJ, Reidsville, GA, (Prison) at 0015. (WP)

425: KPH, Pt. Reyes, CA, at 1115 w/CQ mkr. (DT)

430: Beacon LML, Lomalinda, Colombia, 2644m5 at 0836; Beacon VA, Varadero, Cuba, 1412m, at 0804. (All)

434: WLO, Mobile, AL, in CW w/wx at 30 wpm. Hrd 0030. (WP)

476: CLA, Havana, Cuba, w/tfc lists in 30 wpm CW at 0150. (WP)

478: WNU, New Orleans, LA, w/wx in 30 wpm CW at 0010. (WP)

516: Beacon YWA, Petawawa, Ontario, Canada, 423m, at 0028. (AH)

518: NAVTEX (Sitor-B) KFSO w/warnings of naval gunnery exercises at 0412. (JC)

526: Beacon RWE, Camp Roberts, CA, at 1110. (DT)

530: Public Information Radio WPGU595 w/info of public events and functions in and around Hillard (Columbus, Ohio suburbs). Initially used callsign WMGN 595 but had some kind of mixup with FCC license and changed callsign. (JG)

2955: At 2045, YL rptng SYN2. (Mossad). (SM)

3093: U/I RTTY stn in idle, 75baud, at 0704. (SW)

3234: KAWN Aviation wx (75b RTTY) at 0710. (SW)

3859.2: WA3NAN, Goddard Amateur Radio at 1346 in LSB w/rebcst of audio for launch of STS-69, Space Shuttle Columbia, w/liftoff at 1353. (RB)

3915: CW station in LSB fm 2000-2010 rptng MZ6G. At 2012 into 5F grps. At 2020 sent MZ6G again. Later at 2100 BBC Singapore relay came on freq. (SM)

4154.5: DRAF, FGS Molders (D-186), German Navy guided missile destroyer, at 0245 wkg DHJ59, Wilhelmshaven Naval re RTTY coordination. At 0342, DRDF, FGS U-12 (S-191), German Navy attack sub, at 0342 wkg DHJ59 w/EE voice RTTY coordination. Both in USB. (RB)

4177: 9HNM3, MB Jadran at 0233 in SITOR-A w/sailing report from Continental Grain Elevator, SW Pass, Miss. River, bound Hamburg w/cargo of soybeans (RB)

4270: CFH, Halifax Naval, NS, Canada w/Fax meteo, 120/576, hrd at 0513. (JC)

4303: OXZ3/OXZ4, Lyngby, Denmark in CW w/tfc list at 30 wpm, hrd at 2300. (WP)

4317: ZSC, Capetown, South Africa in CW w/CQ mkr. (WP)

4346: NMC, CommSta Point Reyes, CA w/FAX meteo (satellite view of West Coast) at 0306. (JC)

4408: VCS, Halifax CG, NS, Canada, in USB at 0210 w/wx. (TS)

4463: At 2000 Mossad YL w/FTJ10. Off at 2005. Foll by CW stn sending 287/00. (SM)

4780: At 2100 Mossad YL w/KPA foll by 5L grps. (SM)

4941: At 1820 OM/RR sending strange 5L grps using amongst others, Gustav, Adam, Edward, Ignatius, Marian, Otto, Pavel, Zygmunt, Karl and Ludwig. (SM)

5000: WVVH, Kauai, HI, time signal stn in AM at 1131. (SW)

5431.5: P7X in CW at 2230 w/120 grp msgs interspersed w/data xmsns. Stn on almost every night. (TS)

5530: Mossad YL w/CIO2 announcement, also on 4360//7605 kHz. (SM)

5696: Rescue 2120, USCG HU-25A Falcon Jet, at 0051 wkg NMN, CAMSLANT Chesapeake, for air guard, airborne from ATC Mobile w/5 POB, enroute to posn given re EPIRB activation, later reported vsl was not in distress. NMG, CAMSPAC, Point Reyes, CA, at 0327 w/req for rdo ck, CommSta Kodiak, NOJ & NMN, answer. Note change from San Francisco for CAMSPAC, NMC. At 0730. Air Force Rescue 986, HC-130, wkg NMN w/flight ops normal. All in USB. (RB)

5700: Top Notch wkg Night Watch 01 (NEACP) in USB at 0141 w/rdo check. (TS)

6167: VOA, Washington DC, at 1530 in 110b ASCII w/test xmsn inviting reception reports. (RB)

6230: NRDC, USCGC Campbell (WMEC-909) at 0242 in USB wkg H6E w/relay to NMN, CAMSLANT

Chesapeake, adv freq for H6E to come up on. NMN later came up here wkg H6E direct. (RB)

6269: C6MM2, M/S Ryndam at 1230 in SITOR-A w/BBXX wx obs, Holland-America Lines 55,000 GWT cruiseship. (RB)

6375: WCC, Chatham, MA, in CW at 0033 w/CQ/QSX mkr. (SW)

6387: WNU42, Slidell, LA in CW at 0033 w/CQ/QSX mkr. (SW)

6527: U/i CW stn w/5L grps at 1834. (DS)

6600: Scrambled speech in USB at 0052. (TS)

6658: Mossad-MIW2 callup by YL/EE in AM at 0220. (PS); MIW2 also hrd at 1730. (SM)

6604: Gander w/aviation wx at 0154. (RH2)

6653: At 2345 YL rptng MIW14DO2. (SM)

6730: NIGHT WATCH at 0232 wkg MANGROVE w/tfc, other assets up include OUTBREAK, STARWISH, INTEGRAL, JONATHAN and BLUECOAT, at 0300 NIGHT WATCH w/announcement that 'strategic test is terminated'. At 2151, SAM 204 (86-0204) USAF C-20B Special Air Mission a/c, wkg Andrews AFB for pp SAM COMMAND, re departed Langley 2140, ETA in the blocks 2310. DV3+7. Both in USB. (RB)

6739: ARCHITECT in USB at 0030 w/RAF airfield color codes. (TS)

6879.7: ETD3, Addis Abba, Ethiopia, in RTTY 50/425 at 0354 w/Ry's ID and QRK. Unlisted freq. (PS)

7535: SESEF Norfolk, VA, hrd as follows: NNGH, USS Gunston Hall (LSD-44) at 1408 for HF tests. NDIB, USS Briscoe (DD-977) at 1437 w/HF test. NGUN, USS Gunston Hall at 1634 clg/wkg SESEF w/HF tests. NDWQ, USS Detroit (AOE-4) at 1642 re tests. NDKH, USS Merramack (AO-179) at 1706 re same. Primary mode is USB. (RB)

7536.5: AC4, Assault Craft Unit 4, Little Creek, VA, at 1711 in USB wkg HOPPER 51 (aka Landing Craft Air Cushionedhovercraft LCAC-51) for ETA, at 1723 wkg HOPPER 54(LCAC-54) re status to the launch ramp. HOPPER is nickname for the LCAC's. (RB)

7587.2: RFVITT, Dzaoudzi, Mayotte, French Naval stn in ARQ-E 96/330 at 0300 w/tfc & Z codes. (PS)

7666: At 2250 CW stn (in France?) sending 8BY 8BY 8BY 532/0721776/218/008. (SM)

7777: Scrambled speech in USB at 0332. (TS)

7861.2: PWGU, Brazilian ship (prob Naval) clg PWN33, Brazilian Naval stn, Natal in RTTY 75/850 at 0300. (PS)

7890: YL/SS in AM at 0200 w/5F grps (PS)

7940.1: CLP-1, Havana, Cuba, MFA in RTTY 50/500 at 0700 w/5L grps & MINIREX tlc for Hanoi. Off w/raspy CW. (PS)

8025: CW stn at 0302 rptng KNY25, Rumanian Embassy, Wash. DC. QSY'd to 8027 kHz wkg u/i stn. Sloppy hand-sent CW. (TS); At 1745 Mossad stn rptng CIO2 until 1748. Also on 6745. (SM)

8045: Scrambled speech in USB at 0337. (TS)

8074: OM/RR fm 2010-2015 rptng 417 foll by 398 398 106 106 and into 5F grps. (SM)

8080: NAM, USN Norfolk, VA (Driver, VA) at 0400 w/WEFAX satellite photo of hurricane Luis. (TS)

8083: RIJ75, Tashkent meteo w/chart (fair) in FAX 90/576 at 1648. (RH)

8095: Miami Radio in USB at 0445 w/kg Connie 801 w/pp to Maintenance Control. (TS)

8198: Sydney Radio in USB at 0632 w/pp to u/i Australian ship (8722 kHz). (TS)

8219: KMI, Dixon, CA, in USB at 0635 w/pp to South Korean M/V 6MOT. (8743 kHz) (TS)

8256: U/i hand-sent CW stn at 0354 w/kg u/i stn w/5F ct nbr grps (1-0 = AN34567DNT). (TS)

8297: AAEB, USAV Chickasaw Bayou (LCU-2012) at 0519 in USB clg VIKING Ops, no joy. (RB)

8393.5: OEZK, TR Molodaya Gvardiya at 0426 in 50/170 RTTY w/Ry's & DE to URL, Sevastopol Radio, Then w/RR ETA admin TG & C51 reports from KM Eliov. This is new c/s, not in ITU, for ex-UINN. (RB)

8402: UTQD, BKRT Nataliya Kovshova in RTTY at 0006 wkg URL, Sevastopol w/personal msgs in RR. Vessel is heading out to fishing grounds in West Africa. Passed Gibraltar bnd for Las Palmas, Canary Islands. (MR)

PRICE BREAK-THROUGH
~~\$450~~ **\$379**

NEW Radio Shack PRO-26 200-Channel PORTABLE Scanner

- Continuous coverage from 25 MHz to 1.3 GHz (except cellular telephone frequencies)
- Triple-conversion receiver virtually eliminates unwanted interference
- Hyper-Scan™ circuit scans at 50 channels/second
- NFMWFM/AM mode-select permits tuning TV audio signals
- Automatic scan of 200 memory channels
- Weather key for instant, up-to-the-minute forecasts
- BNC antenna jack for flexible antenna (supplied) or mobile/base antenna (optional)
- Requires 4 "AA" Ni-Cd or alkaline batteries or AC or DC adaptor

Risk-FREE TRIAL 30 DAYS
 Try for 30 days and if not delighted, return for a full refund. S&H excluded. Credit card holders call toll-free or send \$379.00 plus \$14.95 S&H. Check or USPS - Money order. Allow 3 weeks for del. (Texas residents add 8.25% sales tax)

CALL 1-800-433-SAVE Since 1981 **9-5 Central Mon.-Fri.**

<http://www.usradio.com/~usradio>

USRADIO®
 USRadio 377 Plaza, Granbury, Tx. 76048

UNBELIEVABLE RANGE WITH A 3 INCH ANTENNA!

Hear every whisper in a room on your programmable scanner! **UHF UX-50**

Now available in **Model UX-50**

Check these features:

- REALISTIC 1 mile range
- Simple 5 minute assembly
- Measures only 1 1/4 x 3/4 inches
- Runs for days on low-cost 9V battery
- Single-sided board for EASY custom mounting

WHY UHF? Most "miniature" VHF transmitters require a 3 FOOT ANTENNA for any useful range. Our UX-50 transmits farther with a 3 INCH ANTENNA!

WHY SETTLE FOR VHF? Because of high cost and complexity, UHF transmitters are rare. While many companies imitate our products, it's our technology they can't duplicate. We are the first to bring you a true UHF transmitter at a VHF price!

UHF IS PRIVATE! Many VHF transmitters use a cheap computer crystal to transmit on 143 MHz - receivable by EVERYONE with a 2-meter amateur radio! Our UX-50 uses miniature transmitting crystals on one of 4 stocked frequencies away from public bands.

Select your own frequency:

- A: 398.600/605
- B: 399.450/455
- C: 399.025/030
- D: 406.000

Channel selected at random if none specified

We back our product with a **moneyback guarantee** the "toy makers" can't match; we invite you to use our UX-50 for a month and put it to the test. Return it for a courteous refund if it doesn't perform exactly as needed. **Save \$\$\$ - buy 2 or more UX-50's for only \$75 each!** Visa, MC, MO, COD. Add \$3 S&H by UPS.

The leader in wireless design since 1976

DECO Industries* BOX 607 BEDFORD HILLS, NY 10507
 914-232-3878 914-243-0346 (FAX)

8404: TH Rovno in RTTY w/personal msgs in RR wkg Odessa. Hrd 2216. Inbound from N.Z. to Denmark, then Antwerp. (MR)

8414: UUNK, TH Murom at 0503 in SITOR-A w/QTH report to UGC, St. Petersburg Radio, also sends QTH or radio reports for: USWE, UIWN, UOON, UGOV, UPAR, UOUW, UHCC, UGNH, UZKJ, UIIE, UACU, & UUNK in one of the longest list of combined msgs I've seen. (RB)

8459: NOJ, CommSta Kodiak, AK w/USCG meteo in FAX at 0444. (JC)

8496: CLA20, Elavana, Cuba in CW at 0303 w/CQ QXS QSW mkr. (JC)

8533: WLO, Mobile, AL, in FEC at 1750 w/advisories on Hurricane Luis, Tropical Depression Karen and Hurricane Iris. (SW)

8629: KPH, San Francisco, CA in CW at 0252 w/tfc list. (SW)

8971: TRIDENT 753, USN P-3 from VP 26 at NAS Brunswick at 1654 in USB clg BLUES-TAR, no joy. (RB)

9010: Scrambled speech in USB at 0718. (TS)
9040: YL/GG rptng Whisky Lima fm 1930-35 foll by 5F grps for 115 and 522. (SM)

9122.5: WUG, USACE Vicksburg District at 1506 wkg WUH5, Kansas City, MO, and WUE, Albuquerque, NM, as NCS for ck-in to regular Friday net. At 1509. WUK3. Sacramento, CA, wkg WUG for net ck-in. At 1510. WUA, Waltham, MA, wkg WUG for same, at 1511 w/WLJE, Cincinnati, OH, wkg WUA for net ck-in. At 1513 WUJ, Portland, OR, clg for ck-in's, wkg WUJ35, John Day Project Office, The Dulles, OR; at 1527 wkg WUJ312, Bonneville Lock & Dam, Cascade Locks, OR. At 1519, WUH, Omaha, NE wkg WUG re net ck-in. At 1520, WUC5, Jacksonville, FL, wkg WUG w/same. At 1521 WUN, Hanover, NH wkg WUG w/same. At 1522, WUE6, Nashville, TN, wkg WUE4, Huntington, WV, for net ck-in. All in USB. (RB)

9154: D4B, Amilcar Cabral Air, Sal, Cape Verde Island in RTTY 50/810 at 0245 w/RYS & ID. (PS)

9226.1: U/i YL/EE (mean sounding) in AM at 0019 w/5F grps. (PS)

9936: CW stn fm 1420-25 rptng 914 914 914 TTT. (SM)

9955: Bubbling jamming in AM at 0223. (JC)
10638: RFQP, Jibuti, Djibouti, French AF in ARQ-M 200/340 w/Controle DE Voie. (PS)

10662.6: KAWN, poss Elmendorf AFB, Alaska, in RTTY 75/170 at 0204 w/air meteo. (JC)

10868: OM/EE w/184 184 184 1 from 2010-2015. Then 982 34 982 34 and into 5F grps. Ended w/000 000. (SM)

10955.7: RFTJF, French Forces, Port Bouet, at 2139 in ARQ-E 48/850 idling. (RB)

11155.2: RIT, Vayagach, Russia, CIS Navy w/relay tlc from RJD6. (QTH?) in CW at 1900-1904. Also clg RZK QTH?. (PS)

11220: SAM 27000 wkg CROWN for pp. Hrd at 2319. (RH2)

11226: POSTULATE clg NIGHT WATCH 01 here on channel X905. (TS)

11244: U/i w/coded msg at 2147. (RH2)

11334.7: Egyptian diplo stn in ARQ at 2055 w/5F grps. (TS)

11491: YL/EE w/1-0 count and 125 fm 1900-1910, then count 128 and into 3/2F grps. Also on 9219 kHz. (SM)

11522: CW stn sending 5F grps at 2305. Stn rptd grps & signed down w/BT BT 784 784 91 91 00000. (TS)

12127: YL/SS in AM rptng 201 201 201 00000 fm 0040-0045. (TS)

12129: U/i stn w/Piccolo xmsn. Unable decode. Hrd at 1656. (RH1)

12210: At 1300 YL/SS rptng 105 until 1305 then 468 468 40 40 and into 5F. Ended w/00000. (SM)

12215: U/i pulse signal here at 2056. (TS)

12314: YL/GG rptng Juliet Whisky fm 2100-2105 then into 5F grps for 824. (SM)

12497.5: P3AR4, M/V Delfi at 1710 in SITOR-A w/ship info telex to capt. of Port of New Orleans for pre-arrival notice. (RB)

12567.5: YLFB, RTMS Aitsinayams at 1519 in 50/170 RTTY w/admin msg using hull#/ID RTMS-7552, w/tfc to Riga. (RB)



UHBO M/T "NOVOKLAV-4"

**THIS WILL VERIFY RECEPTION OF:
RUSSIAN FLAGGED TANKER M/T NOVOKLAV-4
ON: 12496.0 KHZ. SITOR AT: 2031 UTC DATE: 3 APRIL 1995**

TRANSMITTER/POWER: *"BRIG-2"/1 kWt*

ANTENNA: *Omnidirectional*

LOCATION: _____
VERIFYING OFFICIAL AND STAMP:

Chief Officer



PFC used by Rick Baker, OH, for his Russian Tanker veri.

12579.1: NRV, USCG Guam in SITOR-B at 1530 w/West Pacific wx & Typhoon Polly warnings. (RH1)

12730: NMC, USCG San Francisco, CA, in FAX 120/576 at 1540 w/fair wx chart. (RH1)

12745.5: JJC, Tokyo, Japan, in FAX at 0357 w/nx. (JC)

12903.4: RBSL, Indian Navy, Bombay in RTTY 50/850 at 1545 w/RYS & ID. (RH1)

12916.5: KLB, Seattle, WA, in CW at 2130 w/CQ QXS OBS/AMVER mkr. (JC)

13375: Lincolnshire Poacher stn. Musical number foll by 82001. At 1710 low tones & into 5F grps. YL/EE w/British accent. (PS)

13445: Pulse-type signal, same as usually heard on 12215 kHz. (TS)

13846.8: RFQP, French Forces Jibouti at 1243 in ARQ-E 100/380 w/CDEV. Listed as RFVI Reunion. (RH1)

13954.1: HBD46, Swiss Embassy, Bonn, Germany in SITOR-A 100, w/tfc for Havana at 1227. (PS)

14458.7: DFO46L, PIAB Bonn at 1634 in FEC-A 96/404 w/nx in GG. (RH1)

14475: YL/EE rptng 1-0 count and 050 fm 1400-1410. Then count 225 and into 3/2F grps. (SM)

14621.4: MFA, Cairo, Egypt to u/i stn s/5L grps in ATU-A alphabet. SITOR-A at 1242. (PS)

14692.5: JMJ4, Tokyo, Japan in FAX at 2209 w/meteo chart. (JC)

14731.7: RFVITW, French Forces Reunion at 1230 in ARQ-E 96/428 "FM GROUPEGEND ST DENIS TO PONGENDMOBIL MAYOITE" (Police). (RH1)

14873.5: RFLIG, French naval stn, Cayenne, Guiana, at 2032 in ARQ-E3 96/340 w/nx foll by routing indicators. Circuit identified as CRT. (PS)

14985.8: ZEN69, Hong Kong, in ARQ-M4 192/233 at 1210 wkg WKTI; Victoria I., Hong Kong, idling. (RH1)

15016: YL rptng MIW2 at 1415. Mossad. (SM)

16106.1: SAM, MFA Stockholm at 0820 in SWED ARQ 100/386 w/tfc to Ambassador Lagos, Nigeria in Swedish. (RH1)

16136.3: CLP-1, MFA, Havana, Cuba in RTTY 50/500 fm 2100-2200 w/nx in EE, off w/CW tlc. (PS)

16340.2: CLPB, Cuban Embassy, Conakry in RTTY 75/480 at 1125 w/5L grps for CLPI, Havana, Cuba. (RH1)

16687.5: CBAE, M/V Capam at 1744 in SITOR-A w/SS arrival report via CBV, Playa Ancha, Chile. (RB)

16801.6: UNDB, Sovship TH Ismailia at 1103 in RTTY 50/170 wkg UUI, Odessa. (RH1)

16816.1: ZSC64, Capetown, RSA at 1215 in

SITOR-B w/tfc lists for ZSC, ZSD and ZSQ. (REII)

16907.5: FUV, Djibouti, Djibouti. French Navy at 0300 in RTTY 75/875 w/RYS. (PS)

16958.6: FUM, Papeete, Tahiti in RTTY 75/850 at 1800 w/RYS. (DT)

16977.5: 3BM6, Port Louis Radio Mauritius in CW at 1210 w/tfc list & beacon freq. Info—off freq! (RH1)

17026: KFS, Palo Alto, CA in CW at 1937 w/CQ QXS mkr. (JC)

17049: UUI, Odessa at 1600 in RTTY 50/170 w/Sovship Kapitan Kaminskiy (JFSJ). (RH1)

17068.1: U/i stn in PACTOR at 1559, unable decode. (RH1)

17090: KPH, San Francisco, CA in CW at 1813 w/CQ QXS mkr. (MR)

17139.4: U/i RTTY 100/834 at 1556 in crypt. to. (RH1)

17443.2: BZG48, XNA Beijing, China at 1201 in RTTY 50/425 w/nx in FF. (RH1)

17502.5: At 1200 YL w/William Susan Peter and Queen Robert Union. No msgs. (SM)

17521.9: HSW61, Bangkok, Thailand at 1252 in RTTY 50/757 w/wx coded tlc. (RH1)

18830: Blud to be MFA Cairo, Egypt at 1650 in SITOR-A sending u/i selcall ~ later into 5L grps. (RB)

19418.7: RFFA, MoD, Paris, France at 1550 in ARQ-E3 192/425 idling. (RB)

19747.5: 6VU79, Dakar Meteo, Senegal at 1542 in RTTY 50/425 w/RYS & CQ DE 6VU23/73/79. (RB)

22380: PCH75, Scheveningen, Netherlands at 1515 in SITOR-B w/tfc list. (RB)

22396: LSD836, Buenos Aires, Argentina at 1531 in SITOR-A sending Selcalls. (RB)

Contributors this month included the following:

B—Bunky, IL; RB—Rick Baker, OH; JC—James Callaway, NV; JG—Jim Grandstaff, OH; RG—Rodney Grussling, ID; AH—Al Hemmalin, RI; RH1—Robert Hall, South Africa; RH2—Russ Hill, MI; SM—Simon Mason, England; WP—Walt Petersen, FL; MR—Michael Regan, WI; DS—Don Schimmel, in NC; PS—Paul Scalzo, Quebec, Canada; TS—Tom Severt, KS; DT—Donald Tomkinson, CA; SW—Sue Wilden, IN. Thanks to all! ■

Antenna Tuners: Who Needs 'Em?

There's a lot of hype surrounding antenna tuners, especially when it comes to what they can and can't do. Figuring out whether your station really needs one is half the battle. The other half is finding an antenna tuner with the right features (don't forget affordability!).

Because space is limited, we'll have to greatly simplify our discussion of antennas, transmission lines and transmitters. A full treatment takes volumes (see *The ARRL Handbook* or the American Radio Relay League's *Now You're Talking* for an in-depth treatment of the topic. Both are available from your local dealer or directly from the ARRL).

Basically, your transmitter wants to see an antenna that's as close to an impedance of 50 ohms as possible. Connecting the antenna to your transmitter is a transmission line, probably 50-ohm coax or 300-ohm open-wire (ladder) line.

When the antenna is properly matched to your transmitter, most power sent up the transmission line reaches the antenna and is radiated into space (good!). If the antenna isn't properly matched, some energy in the transmission line bounces back and forth between the antenna and the transmitter instead of being radiated (Not so good! Serious mismatches can greatly reduce your transmitted signal and destroy your transmitter! Also, the greater the mismatch, the less power your rig puts out).

The measuring of this match (or mismatch) is called SWR (standing wave ratio), and it's measured with an SWR meter (naturally!). Very simply, a ratio of 1:1 (or close to it) is best; 2:1 is usable; and 3:1 or greater probably signifies a serious mismatch.

Cutting a wire antenna (or tuning a beam antenna) so it presents a 50-ohm load to your transmitter is pretty easy—if you're interested in operating on a narrow range of frequencies on one band! If you want wider coverage from

the same antenna you can insert an antenna tuner between your rig and your antenna.

By adjusting the tuner's controls, you can "trick" your radio into putting out full power (and be "happy" in the process). When properly adjusted, there's a perfect match between your rig and the tuner (1:1 SWR). There's still a mismatch between the tuner and the antenna, but if you're using a good quality transmission line, most of your precious radio energy makes it to the antenna and is radiated happily away into space.

You Need a Tuner If...

- You want to feed your antenna with open-wire line: Open-wire line (sometimes called ladder line) is almost lossless at HF (much better than coax). The problem is, open-wire line is balanced, while your rig (and your coax) is unbalanced. To bridge the gap, you need an antenna tuner with a built-in balun, a special balanced-to-unbalanced transformer.

- You want to use your antenna on frequencies for which it isn't designed: If you try, for example, to use your 40-meter dipole on 10 meters, the SWR will be very high, and poor performance will result. With an antenna tuner in-line, you'll probably be able to create a 1:1 SWR at your transmitter, permitting operation. (Some mismatches are too great for every [or any] tuner to handle.)

- Your antenna has a narrow SWR bandwidth on some bands: Some multi-band antennas don't offer low SWR from one end of a band to another. With your antenna tuner, you can operate anywhere in the band and still put out full power from a happy radio.

You Don't Need a Tuner If...

- Your SWR is 1.5:1 or less on the frequencies at which you operate: Most modern rigs tolerate an SWR of 1.5:1

or less with no difficulty and put out full power.

- You have a high SWR at VHF or UHF frequencies: Because feedline losses increase rapidly at these frequencies, antenna tuners generally are not useful. The only real remedy is to use a high-quality feedline and a properly matched antenna. No shortcuts here!

- You're interfering with TVs, telephones or other electronic equipment in the neighborhood: Despite what you may have heard, antenna tuners usually don't do a good job cleaning up these problems. Some designs reduce harmonic radiation, but most of the previously mentioned interference is caused by RF overload at the fundamental frequency. Tuners do not reduce this (and actually may make it worse!).

Features and Power Ratings

Useful antenna tuner features: A built-in SWR meter (otherwise you'll have to use an external meter); high-quality inductors, roller or tapped (your antenna tuner is not the place to skimp on component quality!); a built-in balun (for using open-wire line); a built-in antenna switch (your antenna farm likely will grow). Some tuners are automatic—just push a button (these usually are built into your rig) and you're at 1:1 SWR. The problem? They're expensive!

A tuner rated at 300 watts probably will serve your station of 100 watts or less just fine. At certain frequencies, and when trying to match certain transmission-line impedances, RF voltage soars and even can cause sparks or arcing!. This can destroy your tuner or your rig, so when it comes to buying antenna tuners, the greater the power rating the better!

Happy tuning! Send your photos, letters and column suggestions to me at ARRL, Department PCN, 225 Main St., Newington, CT 06111, or write via the Internet to kirk@uslink.net. ■

Hang In There! The Listening Will Get Better

The good news about propagation and sunspots we mentioned last month has been confirmed. The current sunspot cycle indeed has bottomed out. This means we will start noticing changes over the next few years.

The 11-, 13-, 15- and 17-MHz ranges will support signals later into the evenings, even during the winter months. A few years from now, we should be able to hear signals on these bands 'round the world, 'round the clock! Changes will come gradually, though; if you're into instant gratification, you will be disappointed.

Country Cruisin'

There's nothing earth-shaking to report in the way of shortwave broadcast news this month so we'll hopscotch the world, as John Cameron Swayze used to say, and touch on a few items.

Honduras

Radio Copan International is to increase its power from 1 kW to 3.5 kW, which should make it easier to hear. The 15675 kHz frequency currently in use is to be changed; to what, we don't know.

Costa Rica

Radio For Peace International's transmitter on 7385 has been given a power increase. RFPI is reported to be planning to put a station on the air in Hawaii.

Nepal

Bill Matthews, who does the DX news report on Radio Korea, recently visited Radio Nepal. Bill says the veri signer there, Director of Engineering Ram S. Karki, requests that dollar bills not be sent with reports as they usually are stolen at the post office, and the reports never reach the station. It is safer to send three IRCs. If you wish, you may use Karki's home address: P.O. Box 4946, Kathmandu, Nepal. Thanks for the info, Bill!

Libya

What may be a new Libyan government station, Sabha Local Radio, is being reported on 11815 with sign-on at 0745. Sabha is the town where Col. Qadhafi's revolution began. The broadcasts are entirely in Arabic. The full schedule isn't known yet,

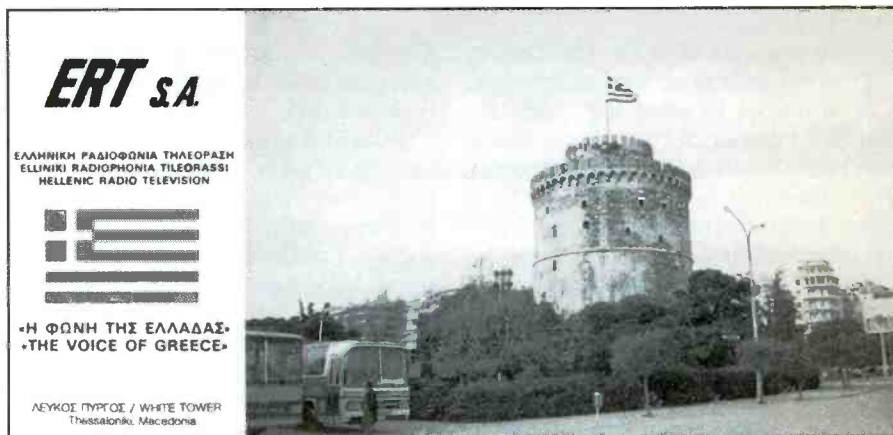

Here's a recent QSL from the Voice of Greece, one in a seemingly endless series of scenic views. (Thanks Adam Smith, WA)

nor can we say whether these broadcasts are permanent or temporary.

Yugoslavia

Radio Yugoslavia is reported to be trying to arrange a swap of transmitter time with China Radio International and Radio Bulgaria. English from Radio Yugoslavia currently airs at 0100-0130 on 6195 and

7115 (except Sundays), 0200-0230 on 6100 and 7115, 1330-1400 on 11835, 1930 to 2000 on 6100 and 9720 and 2200-2230 on 6100 and 6185.

Tanzania

At this writing, Radio Tanzania was being relayed by the Meyerton facilities of Channel Africa, but it may well be a very temporary arrangement. It's currently

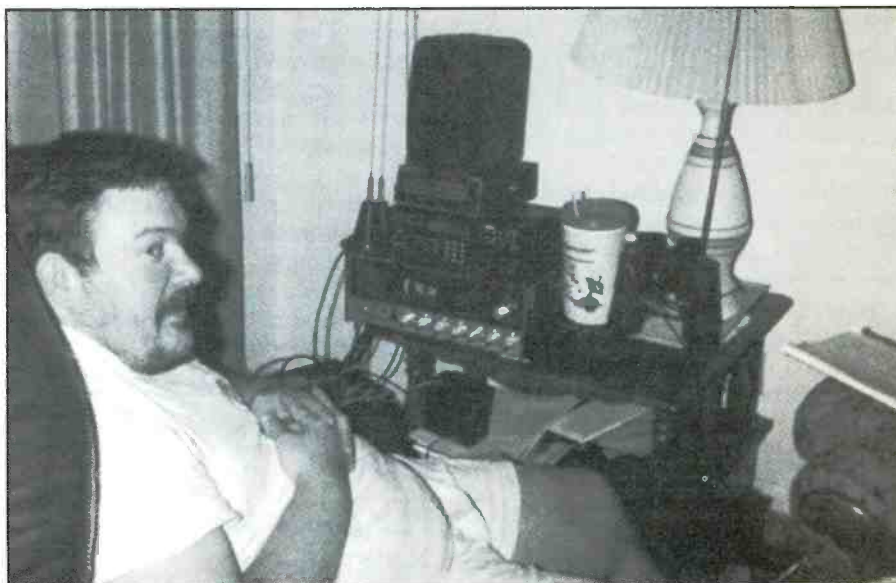

Jeff Weston of Hot Springs, Ark., relaxes in front of his receivers.

THE VOICE OF GREECE							
Short Wave Transmission Schedule, Spring-Summer 1995							
Effective: From 1/7/1995(00.00 UTC) to 24/9/1995 (12.00 UTC)							
Service Area	GMT/UTC		Wavelengths - Frequencies			Languages	1
			m	KHz	m		
EUROPE	06.00-08.00	A	31	9375	31	9425	25 *11645 Gr, Eng
	18.00-19.00	C	41	*7450			Gr
	19.00-21.50	C	41	*7450	31	*9425	Gr
	20.00-20.50	B					31 9375 Eng, F, D, I, S
BALKAN COUNTRIES (MW)	15.00-17.00		31	9425	31	9935	25 11645 Gr, Al, Sc, Bg, R
	19.00-19.50		31	9375			Bg, Al, R, Sc
	19.00-19.30		378,79	792			Bg, Al
	20.30-21.00		378,79	792			Bg, Al, R, Sc, Tr(2)
COMMONWEALTH OF INDEP. STATES & POLAND	17.10-17.50		31	9425	31	9935	25 11645 G, Rus, Pl
TASHKENT ZONE	13.00-13.50		25	11645			Gr, Rus
CYPRUS, TURKEY, MIDDLE EAST	04.00-05.55		31	9375	31	9425	19 15650 Gr, Tr, Ar
	10.00-11.50		31	9425	31	9625	Gr, Tr
AFRICA	12.00-12.50						19 15650 Gr, Ar, Eng
	18.00-18.50				25	11645	19 15650 Gr, Eng
ARABIA, INDIAN OCE	04.00-05.55		31	9375	31	9425	19 15650 Gr, Ar, Tr
	14.00-14.50		*31	*9425	25	11645	19 15650 Gr, Ar
JAPAN	09.00-09.50				19	15650	18 17525 Gr
AUSTRALIA	06.00-08.00		31	9375	31	9425	25 11645 Gr, Eng
	21.00-22.00		31	9375			Gr
	22.00-22.50		31	9375	31	9425	Eng
AZORES	09.00-09.50				19	15650	Gr
N. AMERICA & W. EUROPE	00.00-03.50		31	9425	31	9935	25 11645 Gr, Eng
	12.00-13.50		19	15630	16	17525	Gr, Eng
S. AMERICA - PANAMA ZONE	22.00-23.00				25	11595	Gr
	23.00-23.50		31	9935	25	11595	25 11645 P, I, Eng

(1) Gr.= Greek, Eng.= English, Al.= Albanian, Ar.= Arabic, Bg.= Bulgarian, F.= French, E.= Spanish, I.= Italian, Pl.= Polish, P.= Portuguese, R.= Romanian, Rus.= Russian, S.= Swedish, Sc.= Serb/Croat, Tr.= Turkish
(2) Saturdays=Al, Sundays=Bg, Mondays=Sc, Tuesdays=Tr, Wednesdays=Al, Thursdays=Bg, Fridays=R
(*) Reception possible in Australia
Reception Reports can be sent via INTERNET e-mail: dagget@leon.nrcps.ariadne.t.gr

DETAILS ON PROGRAMMING: ERA-5 "The Voice of Greece"
15342 Messoghion A 432 Athens
Tel.: (01) 6397 375 - (01) 6396 762 Fax: (01) 6397 375

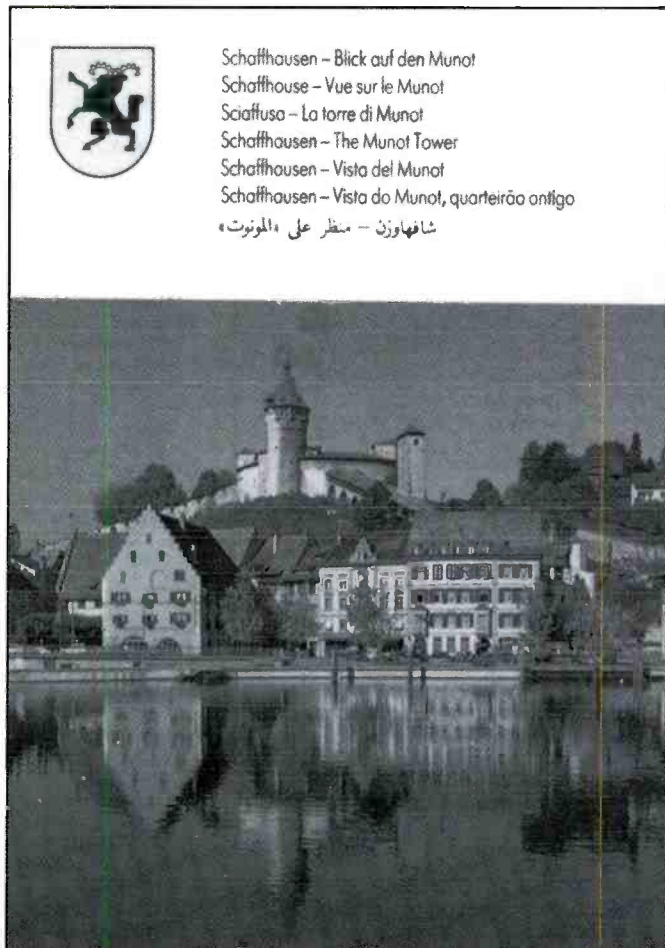

Schaffhausen - Blick auf den Munot
Schaffhouse - Vue sur le Munot
Sciaffusa - La torre di Munot
Schaffhausen - The Munot Tower
Schaffhausen - Vista del Munot
Schaffhausen - Vista do Munot, quarteirão antigo
شاههاوزن - منظر على «المونوت»

Like the Voice of Greece, Swiss Radio International's QSLs often feature views of the country. (Thanks Andy Johns, Mansfield, Texas)

Here's the current Voice of Greece schedule. Note that they accept reception reports via the Internet!

being heard on 15435, scheduled from 0900-1100 and 1300-1525. 7290 also was in use from 0254 sign-on to close at 0455. Also 7280 from 1800-2115, all in Swahili.

Switzerland

Swiss Radio International has discontinued the use of the Brazil relay station.

VOA

Cuts in the Voice of America's budget have brought an end to shortwave broadcasts to Europe where, the VOA says, it's heard quite well on mediumwave anyway. Additionally, programming in Bulgarian, Latvian, Polish and Czech have been dropped. Radio Free Europe/Radio Liberty also is cutting back on its shortwave transmissions.

Sidebanders

These non-broadcast broadcasts always are interesting targets. Two Argentine mediumwave stations recently have been spotted being relayed on shortwave by "utility" transmitters. Radio Rivadavia and Radio America have been noted around 2000 on

20276 lower sideband. It's believed this may be a relay for Argentine troops in Europe. Other frequencies sometimes in use, especially on weekends, are 13280, 15770 and 15780, which apparently are used to beam broadcasts to Argentine citizens in Antarctica.

Another such oddball noted recently consists mostly of music and a program called the *Army Hour*, which is a feature of Romanian government radio. Transmissions are very erratic and are heard any time from 0530 to 1400 on 14201 or 14814, both upper sideband.

SWL Fest

The 1996 Winter SWL Fest, held annually near Philadelphia at the Holiday Inn in Kulpville, Pa., is set for the weekend of March 14-16.

The folks who organize this non-profit event present some top-notch speakers and programs on virtually every aspect of the radio monitoring hobby, including shortwave broadcast listening and DXing. There's always a big room full of displays and goodies, as well as an excellent Saturday night banquet (with entertainment) and a lot of great people. If you can

make the arrangements, try to attend.

For more information, send an SASE to Winter SWL Fest, P.O. Box 591, Colmar, PA 18915. Hope to see you there!

Information Needed

Your log reports (listed by country) always are wanted. The logs are cut up for sorting so please double space (at least) between each item and include your last name and state abbreviation after each. We also welcome spare (non-returnable) QSL cards, stickers, pennants, station photos, schedules and brochures, station news, news about QSL requirements and policies and anything else you think might be of interest. And we still welcome photos of you at your listening post, too!

Here are this month's logs. All times are UTC, which is five hours ahead of EST, i.e., 0000 UTC = 7 p.m. EST, 6 p.m. CST, etc. The broadcast language is assumed to be English unless otherwise indicated (FF=French, AA=Arabic, GG=German, etc.).

ALBANIA - Radio Tirana, 7160 at 0153 with EE news. (Miller, WA) 7270 at 0228 in Albanian. (Williams, TX)

ALGERIA - Radio TV Algerienne, 15160 at 1640 in FF with what sounded like a talk show. (Williams, TX) 15205 at 1610 with music, AA. (Pellicciari, CT)

Abbreviations Used in Listening Post

AA	Arabic
BC	Broadcasting
CC	Chinese
EE	English
FF	French
GG	German
ID	Identification
IS	Interval Signal
JJ	Japanese
mx	Music
NA	North America
nx	News
OM	Male
pgm	Program
PP	Portuguese
RR	Russian
rx	Religion/ious
SA	South America/n
SS	Spanish
UTC	Coordinated Universal Time (ex-GMT)
v	Frequency varies
w/	With
WX	Weather
YL	Female
//	Parallel Frequencies

ANGOLA - Radio Nacional, 11954v in PP at 1530 to past 1600, definite IDs noted. (Conrad, IA)

ANTIGUA - Deutsche Welle relay, 15275 at 1316 in GG. (Williams, TX)

BBC relay, 6195 at 1215. (Jeffery, NY) 15220 at 1314 and 17840 at 1614. (Williams, TX)

ARGENTINA - RAE, 15345 at 2249 in presumed German. Weak. (Williams, TX)

ASCENSION ISLAND - BBC relay to Africa, 11750 at 2000, not parallel to 12095//15400. Also 15400 at 1700. (Conrad, IA) 11750 at 2354, 11765 at 2156 and 15390 at 2244 in PP to Brazil, 17830 at 1615 to Central and Southern Africa, 21640//21660 at 1611. (Williams, TX)

VOA relay on 17875//21490 at 1240. (Williams, TX)

RAI, Italy relay, 11765 at 0152 in II. (Williams, TX)

AUSTRALIA - Radio Australia, 5994 at 1205 and 9580 at 0950. (Wilden, IN) 5995 at 1400 with world news. (Wallesen, IL) 5995 at 1400, 6020 at 0730 and 1400, 9580 at 0700 and 1400. 9615 at 1400 to past 1730, 11660 at 1458 and past 1800, 11695 at 1500 and past 1730. 11800 at 1500, 11880 at 0600 to 0800 and 1700. (Conrad, IA) 5995 at 1205, 6060//6080 in CC at 1250, 9615 at 1207, 11800 at 1258. (Williams, TX) 6020 at 0817 with rugby. (Foss, AK) 6060 at 1225, 6080 at 1220 both in CC. 7150 at 1250 and 7240 at 1120. (Northrup, MO) 11880 at 1702. 17795 at 2205. (Smith, WA)

AUSTRIA - Radio Austria International, 9800 at 0123 with boys choir. (Miller, WA) 13730 at 1145 with letters, Austrian music. (Jeffery, NY)

BOLIVIA - Radio Santa Ana, 4649 at 0418 to 0435 close, ballads, duets, announcement, echo ID. Poor. (Paszkievich, WI)

BOTSWANA - VOA relay, 9885 at 0343. (Foss, AK) 13710 at 2158. (Williams, TX)

BRAZIL - Radio Nacional Amazonas, 6180 at 2250, 11780 at 2156 in PP. (Williams, TX) 11780 at 2210 in PP with ID. music. (Pellicciari, CT)

Radiobras, 15445 at 1318 ending *Brazilian Panorama* with ID and IS (*Girl From Ipanema*) and off at 1320. (Williams, TX)

Radiodifusora Roraima, 4875 in PP at 1035. (Williams, TX) 0334. (Jeffery, NY)

Radiodifusora Manaus, 4805 at 1002 with piano, PP talk. (Williams, TX)

Radio Educacao Rural, Campo Grande, 4755 at 1033 in PP. (Williams, TX)

Radio Cancao Nova, Cachoeira, 6105 at 1048 with religion in PP. (Williams, TX)

Radio Cabocla, 4846 in PP with ballads. (Williams, TX)

Radio Anhanguera, Goiana, 11830 at 2226 in PP.

(Williams, TX)

Radio Bandeirantes, Sao Paulo, 6090 at 0340 with Brazil pops, news, sports, politics, commercials. (Miller, WA)

BULGARIA - Radio Bulgaria, 7195 at 0230. (Williams, TX)

CANADA - CKZN/CBN, 6160 at 2310 with *As It Happens*. Heavy QRM from Radio Netherlands: 6165 from 2327. (Jeffery, NY)

CFRX/CFRB, 6070 at 1630. (Pellicciari, CT) 1225 with ID, commercials, sports. (Northrup, MO)

CHU time station, 3330 at 0240, 7335 at 1228. (Williams, TX) 3330 at 0552. (Smith, WA)

Deutsche Welle Sackville relay, 13790 at 1523. (Williams, TX)

BBC Sackville relay, 5965 at 1202 and 9515 at 1613. (Williams, TX)

Radio Japan Sackville relay, 5960 at 0118 and 6120 at 1149. (Williams, TX)

Radio Canada International, 9805 at 2100 and 11935 (via England) at 1700. (Conrad, IA) 11855 at 1225 with *Royal Canadian Air Farce*. (Wilden, IN) 6150 at 1214, 9590 at 2202, 9635 at 1237, 9805 at 2210, 11955 at 1521, 13650 at 1232, 15305 in FF at 2235, 17820 in FF at 1700. (Williams, TX)

CHINA - China Radio International, 7385 at 0909. (Wilden, IN) 9690, via Spain, at 0210 in CC. (Williams, TX)

Qinghai Peoples Broadcasting Station, 6260 in CC at 2355. (Jeffery, NY)

Heilongjiang People's Broadcasting Station, Harbin, 5950 in CC at 0923. (Foss, AK)

Central People's Broadcasting Station, presumed, 9797 (nominal 9800) in CC at 1214. (Williams, TX)

COLOMBIA - La Voz de Yopal, 5040 at 0045 in SS. (Pellicciari, CT)

Caracol Colombia, 5075 at 0050 in SS. (Pellicciari, CT) 1145. (Williams, TX)

COSTA RICA - Radio for Peace International, 7385 at 2300 and 0000. (Conrad, IA) 15050 at 1900. (Pellicciari, CT)

Radio Reloj, 4832 at 1135 in SS. (Williams, TX)

Faro del Caribe, 9645 at 0142 in SS with news. (Williams, TX)

Adventist World Radio, 5030 at 1258 with ID, pitch for contributions. 9725 at 2301 with IS, address, into religious programs in Dutch. (Williams, TX)

Radio Exterior de Espana relay, 5970 at 1202, 9630 at 1236, 11815 at 1258, 17870 at 1619, all SS. (Williams, TX)

CUBA - Radio Havana Cuba, 6000 at 0407. (Wilden, IN) 6180 in SS at 0404 with interviews. (Miller, WA) 11760 at 1256, 15340 in PP to Brazil at 2238. (Williams, TX)

DENMARK - Radio Denmark, via Norway, 11840 at 1646 in DD with EE ID, program in Danish. (Miller, WA)

ECUADOR - Radio Oriental, 4779.8 at 0220 to 0300 sign-off, with commercials, mentions of Ecuador and Tena, IDs, Ecuadorian music, echo announcements. (Paszkievich, WI)

Radio Baha'i, Otavallo, 4950 at 0220 with religious programs in EE. (Miller, WA)

Radio Quito, 4920 at 0215 in SS. (Miller, WA) 0737. (Williams, TX)

La Voz del Napo, 3280 at 1003 in SS. (Williams, TX)

HCJB - 5900 at 0934 with *Ham Radio Today*. (Wilden, IN)

6050 at 0758 with DX program mentioning Listening Post reporter Marie Lamb. 9745 at 2304 in PP, 12005 at 2240 in GG. 15140 at 1639. 15155 at 1313, 15490 at 1711. (Williams, TX) 6090 at 0332. (Miller, WA) 9745 at 0337. (Foss, AK) 0637 with jazz. (Smith, WA) 15140 at 1920. (Pellicciari, CT)

EGYPT - Radio Cairo, 9620 at 2255 with Mideast music, western pops, news in AA. (Williams, TX) 9900 in FF at 2319, in EE at 2232. (Miller, WA)

ENGLAND - BBC, 5875//6110 at 0130 in SS. (Pellicciari, CT)

5975 (via Antigua) at 0400. (Wilden, IN) 7325 at 2252. (Williams, TX)

Radio Canada, via England, 15325 at 1643 in Slavic language, into EE at 1645. (Williams, TX)

Radio Japan relay, 6055 at 1245 in JJ. (Williams, TX)



ETHIOPIA - Radio Fana, 6210 at 0326 with bell IS, ID, announcements and talk in unidentified language. Poor. (Paszkievich, WI)

FINLAND - Radio Finland International, 11735 at 1220 in Finnish, 1253 in EE. (Williams, TX) 11900 at 1145 with business news and e-mail address. Reception reports go to the Finnish address, not the one in the United States. (Wilden, IN)

FRANCE - Radio France International, 5920 at 0532 in SS with sports. (Smith, WA) 5945 at 2330, 9805 at 1309, 13640 at 1337, 15365 at 1317, 17620//17630 (French Guiana) at 1924. (Williams, TX) 7160 at 2100 sign-on in FF, 11700 in EE at 1600, 12015 at 1600 in EE and 15210 in EE at 1700. (Conrad, IA) 9800 at 0126 in SS. (Miller, WA) 11615//15210//15460//15530 at 1600 in EE. (Pellicciari, CT) 11790 at 0801 in FF. (Foss, AK) Presumed RFI on 15190 at 2230 with ID in FF. (Smith, WA) 15210 at 1600. (Wallesen, IL)

FRENCH GUIANA - Radio France International relay, 5920 in SS at 1011, 13625 at 1229 in EE, 15190 in FF at 2221, 15515 at 1324 and 17860 at 1658 in FF. (Williams, TX) 9790 at 1000, ID and into possible Italian. (Wilden, IN) 17630 at 2005. (Jeffery, NY)

Radio Japan relay, 6070 at 0801 in JJ. (Williams, TX)

GABON - Africa Number One, 9580 in FF to past 2000. (Conrad, IA) 2233 in FF with African choral music. (Miller, WA) 15475 at 1733 in FF. (Jeffery, NY) 17630 at 1325 in FF. (Williams, TX)

GERMANY - Deutsche Welle, 6040 in SS at 2335, 9700 in PP at 2146. 11795 in GG at 2220 and 17765 in GG at 1609. (Williams, TX) 6075 at 0334 in GG, 6085 at 0338 in EE. (Miller, WA) 6135 via Portugal at 0200 sign-on, 9670 in EE at 1900 and PP at 2000, via Rwanda, 11865 via Rwanda (/9670) at 1900, 11905 in EE at 2100. (Conrad, IA) 9640 at 0058 with IS, ID. (Wilden, IN) 11865 at 0804 in GG. (Foss, AK) 15270 at 2148 with ID. (Smith, WA) 17860 at 1920 in GG. (Pellicciari, CT)

GREECE - Voice of Greece, 7450 at 0155 in Greek, 9420 at 0210 in Greek. (Miller, WA)

VOA relay, 7205 at 0218. (Williams, TX)

GUATEMALA - Radio Cultural Coatan, San Sebastian, 4780 at 0141 in SS. (DiOrio, WI) 1147. (Williams, TX) Some SS at times. (Miller, WA) (Onda Musical, Dominican Republic, also operates in this area, as does Radio Oriental, Ecuador. — Editor)

Radio Cultural, 3330 at 0240 in SS. (Williams, TX)

Radio Maya de Barillas, 3325 at 1223 in SS. (Williams, TX)

Radio Buenas Nuevas, 4800 at 1229 in local language. (Williams, TX)

Radio Tezulutlan, Coban, 4836 at 1149 in SS; also 0249. (Williams, TX) 0030 in SS. (Pellicciari, CT)

Radio K'ekchi, 4845 at 1234 with marimba music. (Williams, TX)

GUAM - Adventist World Radio, 13720 at 2203, woman in unidentified language, American pops at times. (Williams, TX)

HAWAII - WWVH, 5000, time checks at 0033.

(Wilden, IN)

KWHR, 9935 at 1538 in EE, 17510 at 2228 in unidentified language. (Williams, TX)

HONDURAS - Radio HRET, 4960.5 at 0040 in SS with choir and religious talks, ID and address. EE religious programming from 0230-0257. (Rausch, NJ)
Radio Luz y Vida, 3250 at 0241 in SS. (Williams, TX)

La Voz de Evangelica, 4820 at 1148 in SS. (Williams, TX) 0020 in SS. (Pellicciari, CT) 0316. (Jeffery, NY)

HONG KONG - BBC relay, 9580 at 1323 with talks on economic and business climate in the Far East. (Williams, TX)

HUNGARY - Radio Budapest, 9850 (ex-9835) at 0157. (Miller, WA)

INDIA - All India Radio, Panaji, Goa, 7250 at 0130 with IS, ID for AIR Ashkavani Panaji, music bridge to news with mentions of Pakistan and Bombay. Address: AIR Panaji, P.O. Box 220, Altinho, Panaji 403 001, Goa, India. (Rausch, NJ) (Note: Major SWBC country lists, notably that of the North American Shortwave Association, count Goa as a separate country. — Editor)
All India Radio, 9910, 9950, 10330 and 15070 all around 1600 in presumed Hindi. (Miller, WA) 11620 at 1900 with news. (Pellicciari, CT)

INDONESIA - Radio Republik Indonesia, Ujung Padang, 4753.3 at 2150 in II, talk by woman, ID music to *Song of the Coconut Islands* and ID at 2200. (Rausch, NJ)

RRI Serui, Irian Jaya, 4606.3 in II at 0907. (Foss, AK)

RRI Jakarta, 9525 at 1236 with EE for Indonesian speakers. Also 9680 at 1210. (Williams, TX)

IRAN - VOIRI, 15084 at 1600 in Farsi. (Pellicciari, CT)

ISRAEL - Kol Israel, 11970 at 1700 in EE to Europe and North America. (Conrad, IA)

ITALY - RAI, 6005 at 0050 with news, 15245 at 1845 with bird IS at 1906 and off the air. (Pellicciari, CT) 17870 at 2306 in II. (Smith, WA) 17780 at 1610 in II. (Williams, TX)

JAPAN - Radio Tampa, 3925 at 1225 in JJ, 6055 at 1254 in JJ. (Williams, TX) 6115 at 0831 in JJ. (Foss, AK)

Radio Japan, 9535 at 1616 in JJ. (Williams, TX) 11840 at 0115, 11910 at 0139. (Miller, WA) 11865 at 2103. (Wilden, IN) 11865 via Gabon at 2100. (Conrad, IA)

Radio Canada International relay, 6150 at 1258 with ID in EE, FF, into CC at 1300. (Williams, TX)

JORDAN - Radio Jordan, 9560 at 2147 in AA. (Miller, WA)

KUWAIT - Radio Kuwait, 9840//15505 at 1950 in AA and 11990 at 1950 in EE. (Pellicciari, CT)

LESOTHO - Radio Lesotho, 4800 at 0304 with man in Sesotho, music. (Jeffery, NY)

MADAGASCAR - RTV Malagasy, 5009.5 at 0255 sign-on in language, IS, ID, news, commercials, high-life music. Reported to be a notorious non-verifier, they QSL'd my FF report and tape in one month. Veri signer is Mme. Rakotoniaina Soa Herimanitra, Secretaire de Direction. I sent \$2, a self-addressed, stamped envelope and used stamps from many countries. The signer collects stamps. The address is RTV Malagasy, B.P. 1202, Antananarivo, Madagascar. (Rausch, NJ) (Nice going, Ed!)

Radio Netherlands relay, 9895 at 1330 with IS, chimes, ID and broadcast to South Asia. (Williams, TX)

MALAWI - MBC, 3380.8 at 0330 with public service announcement for a secondary schools writing contest, high-life music, talk in language. (Rausch, NJ)

MALI - China Radio International relay, 11715 at 0153 in CC. (Williams, TX) 15130 at 1615 with news. (Pellicciari, CT)

MEXICO - Radio Mexico International, 5985 at 1512 in SS, 9705 at 2300 with ID, frequencies and technical data in EE/SS. (Williams, TX) Scheduled 1300-1700 and 2000-0430 on 5985, 9705. (Lamb, NY)

Radio Educacion, 6185 at 0800. (Wilden, IN) 0120 with EE/SS announcement. QRM from Cuba. (Miller, WA)

Radio Universidad, 6044 at 0225 in SS. (Williams, TX)

Radio Mil, 6010 at 1206 in SS with news. (Williams, TX)

Radio XEUW, 6017v in SS at 1140 with ID and quick fade. (Williams, TX)

MOROCCO - RTV Morocaine, 15345 in AA at 1900. (Pellicciari, CT)

VOA relay, 17895 at 1615 to West Africa. (Williams, TX)

NAMIBIA - Namibia Broadcasting Corp., 4965 at 0320 with EE adult contemporary and OM with *Good Morning, Namibia*, morning prayer, woman with "NBC Nationwide. It's 6 o'clock," and news. (Rausch, NJ)

NETHERLANDS - Radio Netherlands, 5995 at 0523. (Smith, WA) 6020 at 2332 with ID, 11730 at 2153 in DD. (Williams, TX) 9605 at 1930, //11655. (Conrad, IA)

NETHERLANDS ANTILLES - Radio Netherlands relay, 5995//6165 at 0447. (Miller, WA) 6020 at 1141, 15315 at 2237. (Williams, TX) 17605 at 1807 in GG, into EE at 1828. (Jeffery, NY)

NEW ZEALAND - Radio New Zealand International, 6100 at 0724 with sports report. (Wilden, IN) 0747 with summary of the week's fruit and vegetable market in New Zealand. (Foss, AK) 9700 at 0737 with ID, schedule. (Smith, WA)

NORTH KOREA - Radio Pyongyang, 6576 at 1240 with Korean music. (Northrup, MO) 13650 at 2300 to North America. (Conrad, IA)

PAKISTAN - Radio Pakistan, presumed, 9400 at 1210 with man and woman talking in unidentified language, no ID. (Northrup, MO) 11570 at 1800 in unidentified language. (Miller, WA)

PAPUA NEW GUINEA - Radio Sanduan, 3205 in Pidgin at 1020 with island choral music, ID at 1030. (Rausch, NJ)

NBC, 4890 at 1152. (Williams, TX)

PARAGUAY - Radio Nacional, 9735 at 1022 in SS. (Jeffery, NY) 0135 in SS. (Pellicciari, CT)

PERU - Radio Imperial, 6420.2 at 0000 with vocals, ID, huaynos, SS talk with guitar. Poor. (Paszkievicz, WI)

Radio Lajas, 5498 at 0307 with vocals, flutes, SS announcements, IDs, time checks. (Paszkievicz, WI)

Radio Sudamerica, presumed, 5522.3v at 0032 to 0041 with vocals, SS announcements, sign-off announcement. Poor. (Paszkievicz, WI)

Radio Frecuencia VH, 4485.1 at 0353 with shouts, ID, vocals, mention of Celendin, ID, huayno. Poor. (Paszkievicz, WI)

Radio Horizonte, 5019.9 at 0205 to 0258 close. Vocals, SS announcements, ID, Foreigner, time check, national anthem. Thanks Marlin Field. (Paszkievicz, WI)

Radio Victoria, 6018.3 at 0427 to 0450 in SS with ID, time checks, chorus, announcements. Parallel to 9720.4. (Paszkievicz, WI)

Radio Sensacion, 6985.3 at 2345 in SS with Andean vocals, ID. (Paszkievicz, WI)

Radiodifusora Huancabamba, 6535.7 at 0211 with vocals, echo ID, mention of "manana," time checks, comunicados. (Paszkievicz, WI)

La Voz de San Antonio, 6627.7 at 0345-0400 plus, pops and huaynos, QRM from North Atlantic aero traffic on 6628. (Zeller, OH)

Radio Andina, 4995.8 at 0240 in SS with full canned ID at 0300 with mention of Huancayo. Slow and up-tempo Peruvian music and birthday greetings. (Rausch, NJ)

Radio Cora, 4913 at 1042 in SS. (Williams, TX)
Radio Concordia, Arequipa, 6140 at 1012 in SS. (Williams, TX)

Frecuencia San Ignacio, presumed, 5700 at 0229 in SS. Quick fade. (Williams, TX)

PHILIPPINES - VOA relay, 6110 at 1259 with technical info, frequencies, address, T-shirt offer and talk of North Korea jamming the VOA-Thailand relay on 9645. Also 6160 at 1257 with EE lessons, into CC at 1300 and 9760 at 1249. (Williams, TX) 11730 at 1500. (Conrad, IA)

PORTUGAL - Radio Portugal, 6095 in PP at

806 - 960MHz

High Gain Wideband Yagi

with 7.1 dB of directional gain to pick out and locate weak signals. Use fixed base or with a handheld scanner. **\$64.95 + 6.49S&H**



1-800-950-WARE

RADIOWARE
PO Box 1478 Westford, MA 01886
Write for FREE Catalog!

CIRCLE 70 ON READER SERVICE CARD

YOU AIN'T HEARD NOTHIN' YET

Since 1967, CRB Research has been the world's leading publisher and supplier of unique hobby and professional books and information including:

Scanner Frequency Guides
Shortwave Frequency Guides
Military/Federal Communications
& Other Related Topics!

Ask For Big Free Catalog

CRB RESEARCH

P.O. Box 56, Commack, NY 11725
Phone: (516) 543-9169/FAX: (516) 543-7486

CIRCLE 11 ON READER SERVICE CARD

Great Offer →

SPEAK WITH AUTHORITY!
THE #1 CB ANTENNAS IN THE WORLD!

CB

▲ FREE CATALOG & DECAL ▲

Firestik Communications
Since 1962

2614 E. Adams St. • Phoenix, AZ 85034
TEL: 602-273-7151 • FAX: 602-273-1836

FREE FIRESTIK ANTENNAS & ACCESSORIES FREE

POPULAR COMMUNICATIONS
CIRCLE 58 ON READER SERVICE CARD

Increase Your Average Audio To Approximately 90%

The Ranger's Speech Processor

SP-1a

\$49.95+ shipping



- Variable Compression & Input Gain
- Works Well With Stock Or Amplified Mic
- Improves Tone Quality
- Processor Completely Bypassed When Turned Off
- Easily Installed In Most CB & Amateur Radios
- Professional Quality, Made & Tested In The USA
- Dimensions 2 1/2" x 1 3/4" x 7/8"



BCB

72 Eastern Avenue
Malden, MA 02148
(800) 473-9708



CIRCLE 54 ON READER SERVICE CARD

0130. (Conrad, IA)

9570 at 2217 in PP and 11855 at 0131 with soccer. (Miller, WA) 15200 in PP at 1910. (Pellicciari, CT) IS and ID at 2200 and soccer in PP. (Williams, TX)

Deutsche Welle relay, 6130 to South Asia at 2000. (Conrad, IA) 9670 at 0143. (Williams, TX)

RUSSIA - Voice of Russia, 6085 in RR at 2100 sign-on, 7105 in EE at 0100 to North America, not at 0200 check. 7180 to North America to 0100, 7270 to North America at 0600. (Conrad, IA) 7270//7345 at 0310 with ID. (Smith, WA) 7345 at 0757 with music. 9665 at 2130 with new age music, news. (Wilden, IN) 11750 at 2219 in EE, 11835 at 2228 in EE and some RR, and 15210 at 1710 in FF. (Williams, TX)

Magadan Radio, Yakutsk, 7320 at 0803 in RR. (Foss, AK)

SAUDI ARABIA - BSKSA, 9555//9870 in AA at 1900. (Pellicciari, CT)

SEYCHELLES - Far East Broadcasting Association, 11675 at 0348 in AA. (Pellicciari, CT)

SINGAPORE - Radio Singapore, 6155 in EE with pops at 1525. (Miller, WA)

BBC relay, 9605 at 1325 in unidentified language, 9740 at 1246 in EE. (Williams, TX)

SLOVAKIA - Radio Slovakia, presumed, 21705 at 1333 in unidentified language. Sounded like a Slavic language, rather than German or Romance. (Williams, TX)

SOLOMON ISLANDS - SIBC, 5020 at 0854 with announcements about upcoming meetings around the Islands. (Foss, AK)

SOUTH AFRICA - Radio Tanzania South Africa relay, 7290 at 0308 in Swahili, with vocals, mention of Dar es Salaam, ID. (Paszkiwicz, WI)

SOUTH KOREA - Radio Korea International, 7275 at 0805 with news in JJ. (Foss, AK) 11810 with EE news at 0104. (Miller, WA)

SPAIN - Radio Exterior de Espana. 6055 at 0000 in SS, 9540 in EE at 0000, 15110//17845 at 1630 in SS. (Pellicciari, CT) 9580 at 2000 in AA. (Conrad,

IA) 11815 at 0113 in SS. (Miller, WA) 15110 in SS at 1638, 17715 at 1326 in SS, 17845 in SS at 1700 (Williams, TX)

SRI LANKA - SLBC, 9720 at 1525 in EE. (Miller, WA)

Radio Japan relay, 11930 at 1700 sign-on in EE, IS, ID, site ID at 1710, Japanese language lesson and media show. (Rausch, NJ)

SURINAM - Radio Apinte, 4990 at 0208 to 0304 with easy listening vocals, Dutch announcements, jazz flute, ID at 0301. Poor. (Paszkiwicz, WI) 0330 with slow pops, man announcer. Low het, presumed from Radio Ancash in Peru. (Zeller, OH)

SWEDEN - Radio Sweden, 6065 in EE at 0030. Blocked by WYFR sign-on at 0045. 11650 at 1430 to North America. (Conrad, IA) 7115 at 0205 in Swedish. Also 9850 in Swedish. (Miller, WA) 15240 at 1430 with news. (Walleesen, IL)

SWITZERLAND - Swiss Radio International, 6135 at 0125, 9885 at 0205 and 15505 at 1322, first two in EE, the latter in FF. (Williams, TX) 9905 at 0405. (Wilden, IN) 0400 with news, Newsnet. (Jeffery, NY)

SYRIA - Radio Damascus, 15095 at 1600 in AA. (Pellicciari, CT)

TAIWAN - Voice of Free China, 7130 at 1230 in CC. (Northrup, MO) 1219 with 1940s and 1950s-style music. EE to Australia. Also 11740, via WYFR, at 0200 in EE. (Williams, TX)

TUNISIA - RTV Tunisienne, 7475 at 2040 in AA. (Pellicciari, CT)

TURKEY - Voice of Turkey, 7190 at 2300 with news, ID, review of Turkish press, *Outlook*, and music. (Jeffery, NY) 9445 at 2338 with Mideast music, ballads in Turkish. (Williams, TX)

UKRAINE - Radio Ukraine, 17725 at 1658 in Ukrainian. (Williams, TX)

UNITED ARAB EMIRATES - UAE Radio, Dubai, 13675 at 1920 in AA. (Pellicciari, CT) 15395 at 1600, IS and talk in EE. (Williams, TX)

UAE Radio, Abu Dhabi, 11885 at 2314 in AA. (Smith, WA) 13605 at 1945 in AA. (Pellicciari, CT)

VANUATU - Radio Vanuatu, 3945 at 0958, old 1940s-1950s ballads. (Williams, TX)

VATICAN - Vatican Radio, 11635 in EE to Africa at 1730 to 1800. (Conrad, IA) 11830 at 1547 with piano, 23rd Psalm chorus. (Williams, TX)

VENEZUELA - Radio Rumbos, 9659 at 0151 in SS. (Miller, WA) 9660 in SS at 2100. Runs past 0500. (Conrad, IA) 2205. (Williams, TX)

Radio Tachira, 4830 at 1004 in SS, national anthem at sign-on. (Williams, TX) 0020 in SS. (Pellicciari, CT)

Ecos del Torbes, 4980 at 0040 in SS. (Pellicciari, CT)

VIETNAM - Voice of Vietnam, 7250 (via Russia) at 0103 with feature on the station's history and interview with "Hanoi Hannah." (Wilden, IN)

Yen Bai Broadcasting Station, 6398 at 0819 in VV. Marching songs and a "vibrant" political speaker. (Foss, AK)

Nice going folks! Three cheers to the following who came through for you: Adam C. Smith, Renton, WA; Marie Lamb, Brewerton, NY; Steve Williams, Corpus Christi, TX; Elmer Walleesen, LaGrange Park, IL; Dave Jeffery, Niagara Falls, NY; Marty Foss, Wasilla, AK; Mark Northrup, Gladstone, MO; Michael Miller, Issaquah, WA; Sue Wilden, Columbus, IN; Ed Rausch, Cedar Grove, NJ; Steve Pellicciari, Norwalk, CT; Sheryl Paszkiwicz, Manitowoc, WI; George Zeller, Cleveland, OH; Jim Conrad, Waterloo, IA; Michael DiOrio, Milwaukee, Wisconsin, and William Matthews, Columbus, OH. Thanks to each of you!

Until next month, good listening! ■



USER FRIENDLY!

The Brand New
1996 POPULAR COMMUNICATIONS GUIDE Is Here

Let the Radio Experts Be Your Guide
What's News and Where To Hear It THE reference for SWLs who want to tune the world's hot spots
ACARS—The latest report for scanner users wanting to tune Aircraft Communications Addressing and Reporting System digital traffic.
How to fill your mailbox with QSL's
Numbers Stations—They're still there here's an in-depth look at this radio mystery!
Our Exclusive exhaustive manufacturer/dealer listing

EXPERT answers to your communications questions: shortwave, scanning and MUCH more!

FREQUENCIES—TIPS—HOW-TO—PRODUCTS

PLUS—comprehensive communications product listings A to Z: Receivers, scanners, CB radios and GMRS (General Mobile Radio Service). Prices, photos and specifications are ALL AT YOUR FINGERTIPS.

Bonus Articles: Tuning the Federal Emergency Management Administration AND how YOU can safely become the extra eyes and ears for law enforcement with your scanner!

Popular Communications
76 N. Broadway, Hicksville, NY 11801 FAX 516-681-2926
Order Toll-Free **1-800-853-9797**

\$5.95
\$2.50 s/h



YOU AIN'T HEARD NOTHIN'... YET

Since 1967, CRB Research has been the world's leading publisher and supplier of unique hobby and professional books and information including:

- Scanner Frequency Guides
- Shortwave Frequency Guides
- Military/Federal Communications
- Broadcast Station Registries
- Covert Operations
- Undercover Communications
- Survival Communications
- Electronic Espionage
- Surveillance
- & Other Related Topics!

ASK FOR BIG FREE CATALOG

New titles are constantly being added to our exciting catalog. If it's interesting and unusual, we've got it. You'll see. Ask for our latest FREE catalog.

CRB RESEARCH

P.O. Box 56, Commack, NY 11725
Phone: (516) 543-9169
FAX: (516) 543-7486

Pirates Den

BY EDWARD TEACH

FOCUS ON FREE RADIO BROADCASTING

Park the Dial on 6955 kHz!

Lots of reports this time, so let's get right into the info! Radio Free Speech was heard by Robert Haas in Pennsylvania at 1257-1305 on 6955 with host "Bill O. Rights." Heard was a Johnny Cash parody, a plug for the A*C*E bulletin and a parody on the national anthem. Bob also had this one with comedy programs at 2128 and 2150. (The Association of Clandestine Enthusiasts—A*C*E—is a club, Bob. Membership is \$20 per year from P.O. Box 11201, Shawnee Mission, KS 66207.) Bob notes that amateur operators around Pennsylvania can find his loggings posted on packet BBSs. Comments to Bob at this packet address: N3PTS@NR3U.# EPA. PA.USA

Magic Carpet Radio was found by Donald L. Tomkinson in California at 0030 on 6955, playing music mostly from the 1970s, including *Magic Carpet Ride*, and some Cajun-style things at tune-in. Donald monitored the broadcast until 0200. The address given was P.O. Box 109, Blue Ridge Summit, PA 17214. IDs by a woman and child as "Magic Carpet Radio."

KNCR was the first pirate log for S.A. Wayland in Arkansas, who heard this one at 0125 on 6955 with odd music and sound effects, and announcing the Blue Ridge address.

Voice of the Dead, heard by Haas at 1440-1507 on 6955 USB with "The Dead Guy" as host and the slogan "all dead people, all the time." Included a comedy bit by Will Rogers and music by Jim Morrison. The address given was 770 Sycamore Ave., Modesto, CA 92803. Christopher White in Massachusetts also had this at 1430-1450 with songs by The Doors and organ music.

Radio Titanic, relayed by NARPS, was heard by Haas on 6955 at 2000 with "Captain Smith from the wreck of the Titanic," ending with a musical ID for NARPS. Reports go to P.O. Box 452, Wellsville, NY 14895.

KNBS-Radio Cannabis, heard by Haas on 6955 USB at 1800 sign-on, with host Phil Music speaking for the "California Marijuana Cooperative." Music, commercial parodies, editorials, "the station with your mind in mind." QSL via Wellsville. Haas had this one again, following the Radio Titanic broadcast, mentioned above, opening in USB mode then switching to LSB at 2037. Dick Pearce had them at 1733, playing various marijuana-related

One day, one frequency...

Pirate Radio Insanity!

7445 Khz

Radio DOOMSDAY

Voice Of the Runaway Maharishi

The Radio Airplane! Shortwave Radio Pirates Broadcasting from the free skies over North America!

RADIO FLUFFERNUT

UNID Unidentified Pirate Radio

NEW YEARS DAY 1994

Holidays are prime time for pirates. Look at the action that took place on New Year's Day, 1994!

songs. Pat Murphy heard it from 1745 to 1800 sign-off featuring Phil Musik and Pot Seedy, with rock by the "Ganga Rebels from Elkhart, Ind."

KTLA was found by Pat Murphy in Virginia on 6955 at 2100-2153 sign-off with the ID, "you're listening to the second broadcast of KTLA, the oldies station." "CJT" was the disc jockey. Dick Pearce in Vermont had this at 2135, but heard the announcer identify herself as "DJT."

Radio USA, was heard by Pearce on 6955 at 2215 with hosts R.F. Watts and Joe King with a program theme of "real people are scarier than monsters."

KOLD, 6955 at 2250 to 2322 close, was picked up by Murphy with 1930s and 1940s music, and a mention of the Stone-

ham, Mass., address (Box 146, Zip: 02180—Editor).

Radio Azteca, 6955 at 1550 to 1614 close, was another log by Haas. This featured a comedy program with "Letters to Doctor Radio," movie previews, DX club program (*World of the Weird*), top-10 lists, etc. The segments were divided by themes from the Bullwinkle, Rush Limbaugh and *Hawaii 5-0* programs. Three stamps for a QSL. Robert heard a repeat of this show a week later, at 2237 in USB mode. Dick Pearce was at a "pizza joint" with his family, waiting for their order to arrive, when he stepped outside and heard Azteca on his portable at 2240.

(Continued on page 77)

Product Parade

REVIEW OF NEW, INTERESTING AND USEFUL PRODUCTS

"See" Digital Aero Communications

As you can read in Capt. William Mauldin's You Should Know column in this month's edition of *POP'COMM*, there is a lot of interest in being able to "view" digital aircraft communications occurring on



The AEA data demodulator and cable are included with the AEA ACARS software package.

dedicated frequencies on the VHF aircraft band. This system is known as ACARS, or Aircraft Communications Addressing and Reporting System.

In order to decode these transmissions from your scanner, you need a special decoder and software. Advanced Electronic Applications Inc. has come out with a new package that contains a small demodulator cable and DOS software that when hooked up to a scanner allows decoding of the digital information being transmitted by planes and ground stations.

The information that can be monitored over these ACARS transmissions can be routine maintenance reports, landing/departure information or even emergency requests from pilots.

AEA offers three versions of its ACARS package:

- The entire AEA ACARS package, including demodulator, software and detailed manual.

- The AEA Fax ACARS upgrade: The demodulator used for AEA Fax (I, II and III) is the same as ACARS, so AEA Fax owners can get the software-only version of AEA ACARS to use with their current demodulator.

- The AEA ACARS 900 package: AEA PK-900 owners already have the hardware built into their data controllers. All they need is this special software-only version of ACARS designed to work with the PK-900.

In addition to having a scanner capable of receiving the signals, you also will need an IBM-compatible computer with a 386 or higher processor.

AEA ACARS is available from most amateur radio dealers. For more information, call AEA's literature request line at (800) 432-8873, fax requests to (206) 775-2340, or write to: Advanced Electronic Applications Inc., P.O. Box C2160, Lynnwood, WA 98036.

Antenna Gets You On 6 Meters

The 6-meter amateur band is an interesting place for hams. While extended range for local communications is possible, it also offers occasional chances to work skip when the band is open.

It's not too unusual to find hams talking on the 50-54 MHz band from faraway distances when the conditions are right. The national simplex calling frequency, 52.525 MHz, sure can become congested during openings.

Cushcraft's ARX-6 Ringo Ranger is an antenna that's easy to get set up and on the air on the 6-meter band. Cushcraft claims the antenna has twice the gain of its AR-6 antenna for 6 meters.

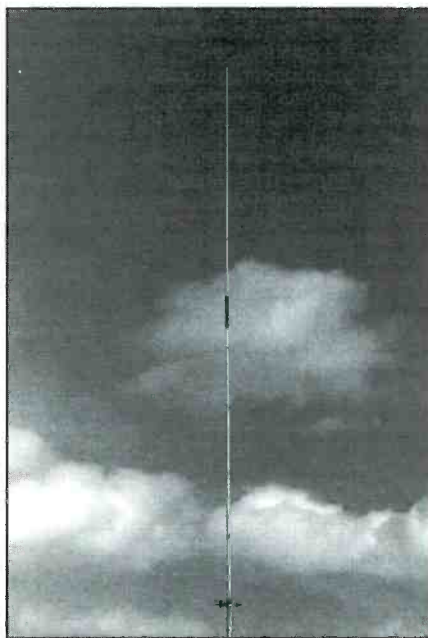

Cushcraft's ARX-6 is a Ringo Ranger that can get you on the 6-meter band quickly!

The ARX-6 antenna stands 24 feet high and has all stainless steel hardware. For gain and wide-area coverage, the Cushcraft ARX-6 antenna might be the ticket.

For more information, contact Cushcraft Corp., P.O. Box 4680, Manchester, NH 03108; phone (603) 627-7877; fax (603) 627-1764.

New Radiating Cable Comes From Andrew

Andrew Corp. announces a new 7/8-inch high-performance Radiax radiating cable that is optimized for frequencies from 900 to 2500 MHz. It is ideal for providing two-way voice, high-rate data and Code Division Multiple Access (CDMA) communications in buildings, tunnels and other enclosed areas.

This new cable can handle all current and proposed Personal Communications Services bands throughout the world.

Other features and benefits of Radiax

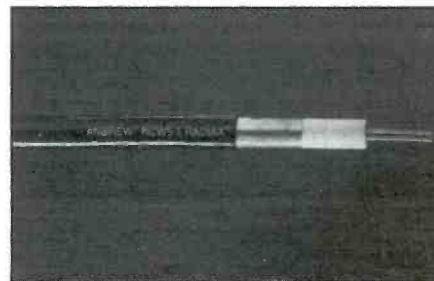

The new 7/8-inch high-performance Radiax radiating cable from Andrew is ideal for tunnels and enclosed areas.

high-performance cable include:

- Enhanced signal containment, as Radiax cable has no high, single-point peak power outputs. This is especially crucial for in-building systems.

- Low-power distribution of signal by Radiax cable minimizes near-far variations in power level.

- Continuous coverage along the length of Radiax cable minimizes shadowing and blocking from structures and people.

We present this product to our readers who have a unique need for specialized usage in more upscale stations.

For more information, contact the Andrew customer support center at (800) 255-1479, Ext. 102, and request bulletin 3723, or write: Andrew Corp., 10500 W. 153rd St., Orland Park, IL 60462.

The Latest from LOWE

HF 150 IBS★★★★

REAL RADIO, RUGGED, RELIABLE

Simplicity makes the HF150 easy to operate, and the synchronous detection produces superb audio which enhances the outstanding performance!

- Frequency: 30kHz - 30MHz
- Multimode: AM, AMN, LSB, USB
- 60 Memories (FREQ. & MODE)
- Tuning Step: 8Hz
- Bandwidth 7kHz & 2.5kHz
- 3 Ant. inputs, 600 Ohm BAL, 50 Ohm Coax and high impedance whip
- Built In Speaker, Ext. Jack & Record OUT
- Power 10-15VDC .15A (.3A max)
- Includes FREE AC adaptor
- Size: 7.3"W x 3.2"H x 6.3"D; 2.9 lbs.



AP150

The Ultimate Lowe Accessory!

A combination audio filter, amplifier and speaker. Works well with any SW receiver or transceiver, but designed to compliment the HF150.

Features:

- 10W Audio amplifier
- Variable notch filter
- High pass filter
- Low pass filter
- Built-in loudspeaker
- External speaker output
- Headphone output



PR150

Pre - Selector w/ Pre-Amplifier

A perfect match to the HF 150, but equally effective with other SW receivers. Obtain wide coverage of 100kHz to 30MHz through the use of seven tunable bandpass filters. Multiple antenna inputs, pre-amp attenuator and much more. Hear what you've been missing!

Antenna input: 50ohm unbalanced, 600ohm balanced • **Power:** 10 - 15VDC

Size: 7.3"w x 3.2"H x 6.3"D



ACARS FROM LOWE...THE AIR MASTER!

A super combination of hardware and software for the receiving and decoding of ACARS (Aircraft Communications Addressing and Reporting System). This format is used to transmit data between aircraft and airport ground stations. This information is transferred via VHF to the ACARS ground station. When using the Air Master software with your PC and an air-band receiver, you'll be able to view the ACARS messages as they are received. The package includes the MS-DOS software for use with a 386 or higher PC, the computer interface and manual.

NEW

HF250

The Lowe HF 250 is set to become the new world standard for mid-priced receivers.

The new HF 250 combines Lowe's traditional high standards and quality of construction together with the advanced facilities and control features required by today's discerning listener!



FEATURES

- * Frequency coverage 30kHz to 30MHz
- * Tuning step size 8Hz
- * Back-lit display
- * Display resolution 100Hz
- * 255 memory channels
- * Memory channels also store frequency, mode, filter selection and attenuator setting.
- * Computer control via RS232 port.
- * Clock with 2 independent timers
- * Fast tuning in 10kHz steps
- * 1MHz up/down tuning
- * Infra red remote commander

WRTVH RECEIVER OF THE YEAR!

HF 225

IBS★★★★

Rated 4 stars by Passport's Larry Magne

- Multimode, AM, SSB, CW • 30 Memory Channels • Optional AM Synchro & FM • Filter for all Modes: 2.2, 4.7, 10kHz 200Hz audio CW filter
- Built-In Speaker, Ext. Speaker, Rec. Jacks
- 10-15VDC .15A (.3A MAX) AC/Nicads Opt.
- Size 10"W x 4.2"H x 8"D; 4.18 lbs.



HF 225E EUROPA

A "Turbocharged" HF225 for the dedicated DXer! Same high performance features of the HF225 plus these additional features:

- 7, 4.5 & 3.5kHz replacement filters for excellent selectivity
- Reduced residual noise thru shielded coils and switching diodes
- Synchronous detector (D225) & KPAD1 standard on Europa version

SEE YOUR DEALER FOR DETAILS!

HF 235

Top of the line rack version of the HF225, with similar specs. A professional communications receiver for the discriminating user, with high stability OSC & opt. computer RS232.

Keypads for the HF150 and HF225, Carrying Cases, Mounting Brackets, and a Computer Control Interface are just a few of the extras which can give you optimum performance of your LOWE product. Contact EDCO for the dealer nearest you!



Electronic Distributors Co.

325 Mill Street • Vienna • VA 22180

Ph 703 • 938 • 8105 FAX 703 • 938 • 4525

Contact your favorite Dealer Today!



CIRCLE 132 ON READER SERVICE CARD

27 MHz COMMUNICATIONS ACTIVITIES

FCC Seeks Help Vs. Illegal Operators

One great thing about writing this column is the mail that people send to CB Scene. I look forward to this mail for two reasons. First, there's all kinds of interesting stuff—shack photos, QSL cards, information requests or help from other readers, and letters with questions, comments and suggestions.

Second, the mail helps me stay in touch with the interests of other CBers, and it often gives me ideas for the column.

There is another reason why I enjoy the mail: It is overwhelmingly positive. CB Scene readers definitely enjoy CB radio as a hobby and a means of communication.

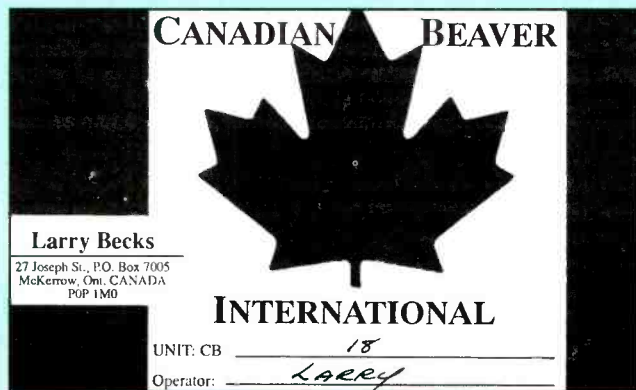
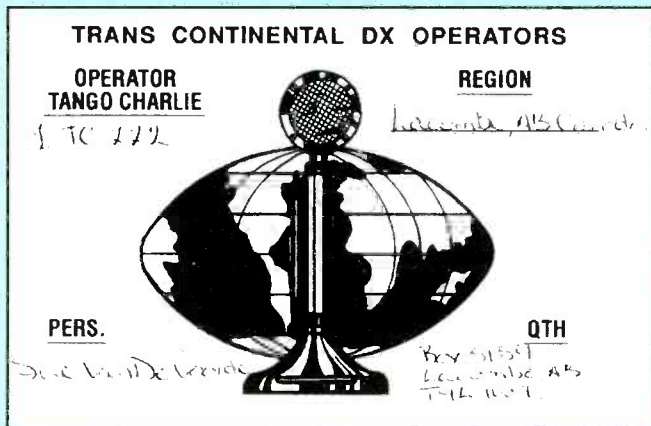
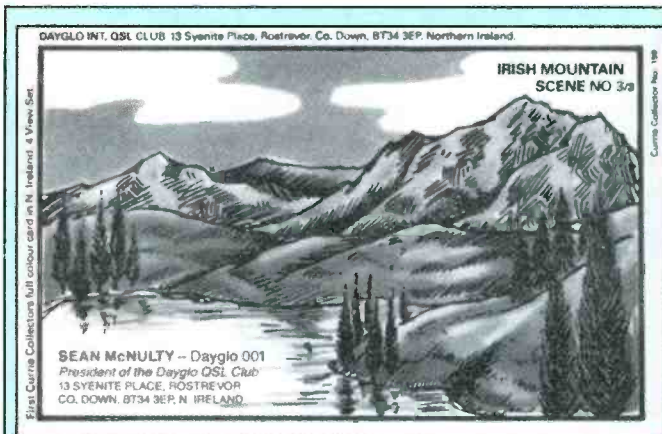

Sue Van De Voorde of Lacombe, Alberta, sent in these neat cards from Canada and Ireland. I particularly like the one with the "Ontario Provincial Bird."

Recently, however, mail of a different sort arrived from the Federal Communications Commission's field office in the Philadelphia area:

The Federal Communications Commission is being inundated with complaints of interference to televisions, telephones, stereo systems and computer equipment caused by citizens band radio operators. Most CB operators are conscientious and, when informed that they are causing an interference problem, correct, or assist in the correction of the problem. In some cases, the difficulty is caused by audio rectification. That fact is acknowledged.

The downside, as in most things, is the "20 percent" who operate above the maximum allowable output power (by far the biggest problem), erect antenna structures in excess of permissible heights, or take it upon themselves to "broadcast" opinions, music or sound effects, preventing others from utilizing the airwaves.

Help is on the way from municipalities, which are now filing "nuisance complaints" against those operators who continue to cause these problems after being contacted by the FCC. Landlords of renters who operate illegal CB systems (where the landlords have been made aware of the situation by the FCC) are being warned that if a delay in 911 emergency services—resulting in an unnecessary death—is found to have been caused by phone interference from a CB, they also may be named in a lawsuit.

If this situation continues to worsen, and with the great demand for the limited airspace still available, we may see legislation introduced to reallocate 27 MHz for other purposes. Amateur operators police themselves to keep the very few among them who violate regulations off the air. It would be a welcome relief to those of us who deal with it on a day-to-day

basis to have some help from those responsible operators who are also tired of these problems.

Our Philadelphia bureau welcomes comments on this matter.

(signed) John Santy
Public Affairs Agent

Well, it seemed pretty obvious that Santy had some things on his mind, so I gave him a call, and we had a long, friendly conversation. He told me that fully 80 percent of the interference complaints that the FCC receives "involve CB radio," and he seemed clearly frustrated by that fact.

He was surprised, however, when I told him that most of the CBers I know are as anxious as he is to rid the air of overpowering operators. I pointed out that there are literally thousands of CBers who take the time to monitor Channel 9 to help people who need emergency services or require travelers assistance, and that there are millions of CBers who simply want to use 11 meters as a means of communications.

But that isn't the end of the story...not by a long shot. At just about the same time that Santy's letter arrived, a friend sent me a copy of a notice from the FCC that had been posted on the Internet.

It said in part: "The [FCC] alone receives approximately 30,000 complaints a year of interference to home electronic equipment. Since it is not feasible for the commission to attempt to resolve these complaints, it is our policy not to investigate interference to home electronic equipment." Santy, however, told me that they do investigate interference complaints, particularly when they have been routed through a member of Congress...because Congress approves the FCC's budget.

The FCC notice, from the Compliance and Information Bureau

Pager Decoder	Pager Decoder	Pager Decoder
Message Tracker 2.0		
Call for Information on our Plus and Pro Versions		
Decode digital pager messages using your PC and scanner. Adaptor connects to your RS-232 port and audio output jack on scanner. The Message Tracker software program allows you to select various options and features.	Starting At \$139⁹⁵ S & H within U.S.: \$4 (outside U.S.: \$10) Tx Residents add 8.25% Sales Tax	
Advanced Features Include:	We currently accept checks and money orders only. Call for latest product and ordering information.	
<ul style="list-style-type: none"> Decodes FSK Signals POCSAG - 512 1200 2400 baud GOLAY (600 baud) Auto Baud Rate Detection Handles GOLAY and multi-speed POCSAG modes on same frequency Allows option to monitor all messages on channel Ability to monitor messages only from your capcode address list Output to File with Time Stamp Displays both Alpha and Numeric Messages Connects to speaker/earphone jack or directly to discriminator output 	Mail Your Order Today!!!	
	Name: _____	
	Addr: _____	
	City: _____	
	State: _____ Zip: _____	
	Phone: _____	
	E-mail: _____	
	Message Tracker 2.0 : \$ 139.95	
	S & H: \$	
	Tx Residents:(8.25%): \$	
	Total Purchase: \$	
K & L Technology P.O. Box 460838 Garland, Tx 75046-0838		
Phone/Fax: 214-414-7198 E-mail: KLTsupport@aol.com		Min. Recommended System : 386
Pager Decoder	Pager Decoder	Pager Decoder

DELTA COMM™ DSS

Digital Signal Strength

Option For Your ICOM™ R7000

DELTA COMM™ I-7000 and your MS-DOS computer integrated with the Delta Research custom CI-V interface and optimized software will not just control but will maximize the potential of your ICOM™ IC-R7000's monitoring capability.

- CYBERSCAN function allows scan file tracking control of systems employing frequency hopping techniques.
- Spectrum log at speeds in excess of 1300 channels a minute, generate a real time histogram of activity and create scan database file automatically.
- Birdie log during frequency search automatically characterizes your R7000, then locks out those frequencies.
- Activity log function continuously monitors and logs all frequencies of a scan database while displaying active, was active and never active channels.

Optional DELTA COMM™ DSS (Digital Signal Strength) upgrade for your DELTA COMM™ I-7000 communication manager.

- Innovative interface design allows digitizing and storing the R7000 signal level information with 8-bit accuracy via your computer's game/joy stick port.
- DSS allows user programmable upper and/or lower signal level detection limits during DELTA COMM™ I-7000's spectrum log, scan and search functions.
- Log signal strength information to printer or delimited log file while DELTA COMM™ I-7000 is scanning or activity logging the selected database file.

DELTA COMM™ I-7000 communication manager program includes all cabling, manual, UL listed power supply and Delta Research custom CI-V interface for \$299.00 + \$8.00 (U.S.) or \$25.00 (foreign) S&H. The DELTA COMM™ DSS interface upgrade comes complete with easy to follow NO SOLDER installation instructions, all cabling and 8-bit DSS A/D converter module (game port required) for \$99.00 + \$8.00 (U.S.) or \$25.00 (foreign) S&H and is available as an upgrade option to registered I-7000 users. Contact us for additional information on DELTA COMM™ registered ICOM™ communication managers for ICOM™ R7100, R71A, R72 and IC735.

Delta Research

Box 13677 • Wauwatosa, WI 53213 • FAX/Phone (414) 353-4567

in Tampa, Fla., then went on to propose a four-point plan:

- The FCC would solicit participation from local electronic repair service organizations.

- Training would be provided for resolving these kinds of interference problems. Training could come from the FCC, manufacturers or industry associations, etc. Once a training course has been completed, the service shop then could be certified as qualified to provide interference protection to electronic equipment.

- The FCC would include a list of qualified technicians with the self-help information they currently mail out in response to interference complaints.

- As part of the program, if the service shop determined the interference could not be resolved by filtering and was caused by a violation of FCC rules and regulations, specific information would be provided to the FCC by the service shop. The FCC then would investigate the situation.

In some ways, this is not a bad idea, but it does have an inherent flaw. It says nothing about specifically protecting emergency frequencies such as CB Channel 9 and others. Surely it is more important to make sure that someone's call for help can be heard than to make sure that someone can watch TV or listen to music.

A Modest Proposal

I'd like to propose an alternative solution—one that would help folks in trouble: CBers, the FCC and people with interference problems—the establishment of a national Citizens Radio Corps. The CRC would have two missions:

- To monitor and, when appropriate, respond to distress calls on frequencies that are available to the public. These are: CB Channel 9 (27.065 MHz), the marine distress frequency (VHF Channel 16, 156.800 MHz), the aircraft emergency frequency

(121.500 MHz), and the General Mobile Radio Service travelers assistance frequency (462.675 MHz). CRC operators would be trained and licensed to provide appropriate emergency response communications on these frequencies.

- To detect and resolve interference problems on any of these frequencies. With proper training and licensing, CRC operators would be empowered to locate stations that may be causing interference, to inspect those stations and to issue notices of violation. CRC operators would be volunteers, although they probably should be protected by various forms of government-issued insurance in case they are injured or sued as a result of their participation in the Civilian Radio Corps. In addition, there would be stiff penalties for any CRC volunteer who violates his or her privileges.

The CRC would resolve a number of problems: it would put more people in the business of monitoring emergency frequencies, which would be of great benefit to the public, and it would empower those who monitor to protect those frequencies at a time when the FCC is shrinking in size. At the same time, it would likely rid the air of CBers and others who are operating their radios in such a way that it causes interference.

What do you think? Is it a good idea? A crummy idea? Are you willing to participate? Let me know, or write to John Santy, Federal Communications Commission, One Oxford Valley, Room 404, 2300 E. Lincoln Highway, Langhorne, PA 19047.

CB To The Rescue

I am indebted to *News Briefs*, the newsletter published by Tri-County Assistance, P.O. Box 111, Cohoes, NY 12047, for the following item that drives home the effectiveness of CB Channel 9:

"Imagine yourself, cruising along on your way home after a long day at work, on a sunny Thursday afternoon. Everything is fine so you start to relax and enjoy the warmth of the late-day sun shining through the car window. Suddenly you realize your vehicle is out of control and you are about to crash. Wham. There you are in the ditch and in pain. You want help. You need it and it can't get there too soon. Little do you know that several calls already have been placed by passing motorists to the state police on 911. Maybe it is best that you don't know, because they are being dispatched to the wrong location—twice!

"This scenario is not as far fetched as it may seem. In fact, it happened on Interstate 87, the Northway, in Half Moon, N.Y. Fortunately, this is a very active area for CB Channel 9 and within seconds of the crash, several of the "regulars" had stopped at the scene and established contact with a nearby base. 'Break 9, we've got a rollover in the ditch, 87 northbound south of Exit 8,' Larry Zuravin reported of and on the way to the scene—the right one this time.

"With state police still on the phone, Larry got back on the air with Empire Central REACT. 'Repeat the location,' replied the base. 'State is looking for it south of Exit 10 and south of the twin bridges.'

"'We are right at the nine mile marker,' Larry insisted, 'south of Exit 8, the car is in the right-hand ditch, and I am getting out to check for injuries. Stand by.'

"In the silence that followed, the base monitor contacted the state police and updated them on the correct location of the accident. The patrol cars soon were redirected by their dispatcher.

"'Just the driver in the car,' Larry said, 'we need an ambulance!' It was dispatched before police got to the scene and arrived many minutes before it would have if it had not been for CB and the well-practiced local operators on Channel 9. Not only were we able to confirm the location and that there were injuries, which sped aid to the right scene, but during the backups that lasted more than an hour, CBers were able to inform motorists about the delays so that they could avoid them."

Next, time, we'll dip into the mailbag and see what other surprises are there. Until then, be sure to write to me here at POP'COMM. ■

CB Radio

The Fun is Back!

CB Radio Magazine

CBing is having fun. Meeting people. Jamborees. Staying in touch with your community, and so much more.

CB Radio brings to you all the CB Radio fun, more CB Radio variety, more CB Radio excitement than you ever thought imaginable.

Join the Fun! Subscribe Today!

Subscription Rates

1 year - \$21.95	Canada/Mexico—One year \$31.95, two years \$59.95, three years \$89.95. Foreign—one year \$33.95, two years \$63.95, three years \$95.95. Foreign Air Mail—one year \$81.95, two years \$159.95, three years \$239.95.
2 years - \$39.95	
3 years - \$59.95	

Payable in U.S. dollars only.

Note: Allow 6-8 weeks for delivery of first issue.

1-800-853-9797

CB Radio Magazine

76 N. Broadway, Hicksville, N.Y. 11801

Phone: 516-681-2922 FAX 516-681-2926



NRD-535D

"Best Communications Receiver"

World Radio TV Handbook 1992



"Unsurpassed DX Performance"

Passport to World Band Radio 1992

Setting the industry standard once again for shortwave receivers, the NRD-535D is the most advanced HF communications receiver ever designed for the serious DXer and shortwave listener. Its unparalleled performance in all modes makes it the ultimate receiver for diversified monitoring applications.

Designed for DXers by DXers! The NRD-535D (shown above with optional NVA-319 speaker) strikes the perfect balance between form and function with its professional-grade design and critically acclaimed ergonomics. The NRD-535D is the recipient of the prestigious World Radio TV Handbook Industry Award for "Best Communications Receiver."



Japan Radio Co., Ltd.

Japan Radio Company, Ltd., New York Branch Office - 430 Park Avenue (2nd Floor), New York, NY 10022, USA Tel: (212) 355-1180 / Fax: (212) 319-5227

Japan Radio Company, Ltd. - Akasaka Twin Tower (Main), 17-22, Akasaka 2-chome, Minato-ku, Tokyo 107, JAPAN Tel: (03) 3584-8836 / Fax: (03) 3584-8878

- Phase-lock ECSS system for selectable-sideband AM reception.
- Maximum IF bandwidth flexibility! The Variable Bandwidth Control (BWC) adjusts the wide and intermediate IF filter bandwidths from 5.5 to 2.0 kHz and 2.0 to 0.5 kHz—continuously.
- Stock fixed-width IF filters include a 5.5 kHz (wide), a 2.0 kHz (intermediate), and a 1.0 kHz (narrow). Optional JRC filters include 2.4 kHz, 300 Hz, and 500 Hz crystal type.
- All mode 100 kHz - 30 MHz coverage. Tuning accuracy to 1 Hz, using JRC's advanced Direct Digital Synthesis (DDS) PLL system and a high-precision magnetic rotary encoder. The tuning is so smooth you will swear it's analog! An optional high-stability crystal oscillator kit is also available for ± 0.5 ppm stability.
- A superior front-end variable double tuning circuit is continuously controlled by the CPU to vary with the receive frequency automatically. The result: Outstanding 106 dB Dynamic Range and +20 dBm Third-Order Intercept Point.
- Memory capacity of 200 channels, each storing frequency, mode, filter, AGC and ATT settings. Scan and sweep functions built in. All memory channels are tunable, making "MEM to VFO" switching unnecessary.
- A state-of-the-art RS-232C computer interface is built into every NRD-535D receiver.
- Fully modular design, featuring plug-in circuit boards and high-quality surface-mount components. No other manufacturer can offer such professional-quality design and construction at so affordable a price.

Washington Pulse

FCC ACTIONS AFFECTING COMMUNICATIONS

New Experimental Stations

KQ2XYW, Radio Sound Inc., CB channels. Fixed and mobile in Louisville, Ky. Test and demonstration prior to export.

KB2XOU, Rockwell International, 112.050 MHz. Fixed in Cedar Rapids, Iowa. Investigate Global Positioning Systems applications.

KQ2XYM, Rockwell International Corp., 123.425 MHz. Fixed and mobile in Richardson, Texas. Conduct experiments integrating GPS with traditional navigation systems and enhancing GPS systems to improve their accuracy and suitability for use in air traffic control.

KS2XBH, LoJack Corp., 173.075 MHz. Fixed and mobile in continental United States. Operate one temporary fixed unit and up to 10 mobile units to demonstrate the potential benefits of the LoJack stolen vehicle recovery system to state and local law enforcement agencies and to provide assistance during the system design.

KS2XBB, CTA Space Systems Inc., 401.650 MHz. Fixed and mobile in McLean, Va. Perform satellite verification test of radios manufactured for use with Service ARGOS.

KF2XDL, Princeton University, 460.500 MHz. Fixed and mobile in Palestine, Texas, and Princeton, N.J. Communications support of balloon-mounted telescope.

KQ2XYN, Sharp Microelectronics Technology Inc., 824-849 MHz. Mobile in Portland, Ore., and Seattle and Vancouver, Wash. Field test cellular equipment.

KE2XPZ, Watkins-Johnson Co., 824-849, 869-894, 1850-1910 and 1930-1990 MHz. Fixed and mobile in Gaithersburg, Md. Test and development of cellular and PCS equipment.

KE2XGI, Motorola Inc., 901-902, 930-931 and 940-941 MHz. Fixed and mobile nationwide. Development of two-way paging equipment.

KS2XBV, Advanced Digital Technologies, 902-928, 2400-2483.3 and 5725-5850 MHz. Fixed and mobile nationwide. Perform field and laboratory testing of spread-spectrum equipment.

KS2XCA, Motorola Inc., 901-902, 930-931 and 940-941 MHz. Fixed and mobile in Fort Worth, Texas. Research and experimentation of time-division duplex high-speed data transmission.

KS2XCS, Lockheed Martin Corp., 902-928 and 2400-2483.5 MHz. Mobile

in Middle River and Aberdeen, Md. Provide a video link from remote-controlled robots.

KS2XBX, Colorado Department of Transportation, 915 MHz. Mobile in Colorado. Testing to determine the usefulness of video imagery and 35mm photography of various types of highway engineering problems by using a radio-controlled model airplane as a camera platform.

KE2XPE, Mitre Corp., 966 MHz. Fixed and mobile in Bedford, Mass.; Salt Lake City, Utah; Melbourne, Fla. Test and development in support of air-air and air-ground surveillance.

KE2XPQ, Comsat, 1626.5-1646.5 MHz. Fixed in Clarksburg, Md. Operate INMARSAT Standard-C land-based terminal for customer demonstration, evaluation of system integrity and for testing and evaluation of value-added services.

KS2XBO, State of Florida, 1626.5-1660 MHz. Mobile in Florida. Operate five INMARSAT-M terminals.

KS2XBU, State of Alaska Division of Information Services, 1626.5-1660.5 MHz. Fixed in Alaska. Operate INMARSAT-M terminal for emergency communications.

KQ2XYG, PCS Primeco L.P., 1850-1990 MHz. Fixed and mobile in Fort Lauderdale, Tampa, Jacksonville and Orlando, Fla.; Milwaukee, Wis.; Chicago, Ill.; Kenner, La.; Irving, San Antonio, Houston and Austin, Texas; Honolulu, Hawaii; and Richmond, Va. PCS tests.

KS2XBW, AT&T Wireless PCS Inc., 1850-1990 MHz. Fixed and mobile nationwide. Determine propagation characteristics of frequencies in metropolitan trading areas (MTAs) where AT&T was successful bidder for broadband PCS licenses.

KS2XCD, Harris Corp., 1920-1930 MHz. Fixed and mobile in Redwood City, Calif. Test wireless PABX system at Faron location.

KQ2XWO, CTA Space Systems, 2075 MHz. Fixed in McLean, Va. Utilize Payload Operation Control Center in Tyson's Corner, Va., to provide command, control and communications with the NASA-sponsored METEOR spacecraft.

KE2XNV, TCOM L.P., 2202.5, 2210.5, 2280.5, 4575, 4650 and 4725 MHz. Fixed and mobile in Elizabeth City, N.C. Communications supporting aerostat radar tests.

KC2XFM, Iotex Communications Inc., 2400-2483 MHz. Fixed and mobile in continental United States. Operate direct-sequence spread spectrum T1 links.

Deadline Set For Older Aero Radios

The Federal Communications Commission has received numerous inquiries from the general aviation community concerning the continued use of VHF aircraft radios with 50-kHz channel spacing (320-channel radios). As of Jan. 1, 1997, these radios no longer will be authorized for use in FCC-licensed aircraft stations. New or replacement VHF aircraft radios must utilize 25-kHz channel spacing (720-channel radios) and meet the required frequency tolerance.

Channel spacing and frequency tolerance specifications for a specific radio may be found by consulting the user's manual for the unit, by contacting the manufacturer or by consulting a local aircraft radio dealer or repair shop.

The FCC first authorized the use of spectrally efficient 25-kHz-channeled VHF aircraft radios in 1972. Nineteen years later, the commission amended its rules in 1991, to eliminate the use of 50-kHz-channeled VHF aircraft radios by 1997. Such radios usually are found in private, single-engine aircraft operating in rural areas. In that proceeding, the Federal Aviation Administration, Aeronautical Radio Inc., the Air Line Pilots Association, the Air Transport Association and the National Business Aircraft Association Inc. all strongly supported the elimination of the 50-kHz-channeled radios.

The commenters noted that users of the older radios would have limited access to FAA air traffic control channels, would experience flight delays in FAA-controlled air space and would be unable to utilize newly available aviation frequencies in the 136-137-MHz band.

Issues Raised Over EAS Replacing EBS

The FCC has addressed issues raised on reconsideration of the report and order concerning the replacement of the Emergency Broadcast System (EBS) with the new Emergency Alert System (EAS).

On Nov. 10, 1994, the commission adopted a report and order and further notice of proposed rulemaking that replaced the existing EBS with the new EAS. By that action, the commission required broadcast stations and cable television systems to install and operate new equipment for national alerts and relaxed requirements for non-commercial educational

W R T H
BEST RECEIVER 1992

As changing world events bring us all closer, it's exciting to get the news direct from a foreign station. So tune in and listen – even when you're 12 time zones away. The drama of survival efforts. Crisis monitoring when conventional communications break down. The uncertainty of economic trends. And colorful cultural activities.

Don't wait for someone else to tell you what's happening. The FRG-100 Worldwide Desktop Communications Receiver puts you in the action now. The FRG-100 is a winner, too. It won the prestigious WRTH award for "Best Communications Receiver" in December 1992. No surprise with exclusive features like adjustable SSB carrier offset and selectable tuning steps in 10, 100 and 1000 Hz.

But you're the real winner! Priced lower than receivers with fewer features costing much more, the FRG-100 delivers extraordinary, affordable performance. For news and entertainment from far away places – a little closer than before – listen to the FRG-100 at your Yaesu dealer today.

FRG-100 Worldwide Desktop Communications Receiver

- Covers all short-wave bands including 50 kHz-30 MHz
- 50 Memory Channels
- Twin 12/24 Hour Clocks
- Programmable On/Off Timers
- Selectable Tuning Steps (10, 100, 1000 Hz)
- Built-in Selectable Filters 2.4, 4, 6 kHz (250 or 500 Hz options)
- Dual Antenna Connections (Coax and Long Wire)
- Bright LCD Display
- Operates on AC or DC
- Compact Desktop Size
- Memory or Group Scanning
- 16 Preprogrammed Broadcast Bands

YAESU

Performance without compromise.SM



Yaesu helps bring the world a little closer.

© 1994 Yaesu USA, 17210 Edwards Road, Cerritos, CA 90701 (310) 404-2700

Specifications subject to change without notice. Some accessories and/or options are standard in certain areas. Check with your local Yaesu dealer for specific details.

CHEEK

The Ultimate Scanner!

The King of Scanners takes this step-by-step, richly illustrated, bench manual beyond everything ever published on scanner mods. Bill is a perfectionist who will help you convert your scanner into precisely what you've always wanted!

MAY 1995

244 pgs, large format, \$29.95

EMERGENCY RADIO!

Scanning News As It Happens

"Excellent..." Barry Goltwater

"Rates a 10!" Dispatch Magazine

Norm Schrein

24 pages, \$14.95

"A winner..." 911 Magazine

"Irresistible!" Bill Cheek

SCANNERS & Secret Frequencies

"Must reading..." Electronics Now

"A great undertaking..." Monitoring Times

"Absolutely the best..." Norm Schrein

Henry Eisenson

320 pages, \$19.95

"Useful, knowledgeable..." PopComm

"You can't miss!" ASG

"A high point!" RCMA

Underground Database

400 things that are sort of legal. SCARY!!!

100 pages, large format, \$23.75

Television GRAY Market

Cable & satellite chips, descramblers, etc.

"Explores this shadowy fringe area in depth... good info..." PopComm

Henry Eisenson

160 pages, \$23.75

INDEX Publishing Group, Inc.

3368 Governor Drive, Suite 273P

San Diego, CA 92122

619-281-2957 (editorial)

First book \$4 s/h, \$2 ea add'l

CA add 7.75% tax

MD/check via mail.

Order line 800-546-6707

CIRCLE 62 ON READER SERVICE CARD



When ordering back issues include the following information: Name, address, city, state & zip. Please make a list of the issues you're requesting. When paying by credit card send the number along with the expiration date. Check, Money Order, Mastercard, VISA, Discover and AMEX accepted.

Complete your collection today.

1-800-853-9797

or Fax 1-516-681-2926

Popular Communications

76 North Broadway

Hicksville, NY 11801

Class D FM stations and low-power television stations.

On reconsideration of the report and order, many petitioners requested changes to the rules regarding alternative use of Radio Broadcast Data System (RBDS) subcarriers for EAS alerts, cable television system override of broadcast signals during EAS alerts, or time extensions for the implementation of the EAS requirements.

Upon review, the commission declined to incorporate the RBDS in the EAS rules. The commission also declined to make modifications to the FM broadcast rules to accommodate RBDS. The commission rejected the petitioners' argument that requiring video interrupt and audio override of broadcast signals by a cable system on which they are transmitted violates the copyright law and the must-carry rules. Therefore, the commission will not require cable systems to install more expensive selective override equipment.

Additionally, in light of the technical adjustments and clarifications being made and to allow implementation to occur in a later budget year, the commission delayed the implementation date of the EAS for broadcasters to Jan. 1, 1997. The commission, however, encourages all broadcasters and cable television systems to proceed with implementation of the EAS as expeditiously as possible.

Internet Access to Shortwave Schedules

The FCC's International Bureau announces that information about U.S. shortwave international broadcasting stations is now available on the Internet. The FCC oversees the frequency coordination process for private U.S. shortwave broadcasters, developing consolidated schedules that are coordinated internationally.

These schedules change on a seasonal basis at least twice a year—with additional refinements made intermittently. Because of the frequency and complexity of the updates, use of the Internet will make more efficient the FCC's distribution of current information to shortwave broadcasters and the general public. The process is now handled manually.

Available data includes station operating parameters, seasonal operational frequency schedules, international coordinated frequency schedules, current issues and announcements, and other related material.

The information is available in two ways: *Using the World Wide Web:* A new set of web pages has been added on the commission's Internet host that will provide access using commonly available WWW navigators such as Mosaic and Netscape. The pages then can be accessed by setting

the location to: http://www.fcc.gov/Bureaus/International/WWW/HF_broadcasting/hf.html.

Alternatively, you can access the FCC welcome page at <http://www.fcc.gov/Welcome.html> and follow the links to the International Bureau—Hot Topics—HF broadcasting.

Using file transfer protocol, or FTP: If a WWW browser is not available, the files can be retrieved using FTP. The commission's FTP server is <ftp.fcc.gov>. Login as "anonymous" and use your e-mail address as a password. HF files can be downloaded from the /pub/Bureaus/International/WWW/HF_broadcasting_directory.

HF schedules and station parameter files are located in this directory and have a "txt" file extension.

FCC Revises Tariff-Filing Rules

The commission amended its rules to require domestic, nondominant common carriers to file tariffs containing specific rates rather than rates expressed as a range of maximum and minimum charges. The action is in response to a decision by the U.S. Court of Appeals for the D.C. Circuit to vacate the commission's 1993 Nondominant Filing Order, which permitted domestic, nondominant common carriers to file tariffs containing rates expressed in a manner of the carrier's choosing, including a "reasonable range of rates."

The court stated that allowing carriers to express their rates as a range of charges violates the Communications Act of 1934, which requires every common carrier to file "schedules showing all charges."

Based on the extensive record developed in the rulemaking that preceded the order, the commission again concluded that the significantly streamlined tariffing requirements for nondominant common carriers continue to serve the public interest by affording these carriers increased flexibility to meet their tariff-filing obligations. The commission construed the court's decision as invalidating only the range of rates provision. Accordingly, the commission reinstated all other tariff-filing rules for domestic, nondominant common carriers adopted in the Nondominant Filing Order.

The commission also amended its rules to delete references to the FCC's forbearance policy that are inconsistent with earlier court decisions vacating that policy and to implement changes made by erratum to the Nondominant Filing Order, which had been erroneously omitted from the Code of Federal Regulations. Finally, the commission denied a petition for partial reconsideration of the Nondominant Filing Order and dismissed as moot an application for stay of that order. ■

You Should Know (from page 42)

screen. I quickly found out that ACARS systems will often send data messages that aren't always readable. Some of these are computer housekeeping and others just weren't programmed into my reader for display. As the hobby of reading data bursts and ACARS expands, you can bet that the hobby market will demand and get better terminal units and improved data-reading capability.

You will be limited by your listening location and equipment. Remember, aircraft communications normally are considered "line-of-sight" VHF transmissions. The ground station will not be readable unless you live near the ground transmitter site, probably located at the airport. Aircraft transmissions, especially if the plane is at high altitude, can be received from a distance of 200 miles away.

Monitoring data transmissions and the interest in this subject is expanding at a rapid pace. Before long, data readers will be a common item on the hobby catalog menu and on the listening equipment table of most serious hobbyist. This can be an exciting and interesting part of the communications hobby. You must do your homework to get full enjoyment from ACARS, but information is available. I hope I have given you just a bit of insight into what is out there on ACARS. ■

Pirates Den (from page 67)

WRV—Radio Virus, was picked up by Haas on 6955 at 2205 with rock 'n' roll and a comedy sketch by Feinstein Theater. Also an AIDS announcement. The host was Pete Pirate.

Friday Radio, "celebrating the weekend," was another Pearce logging, on 6954.5 USB at 2345. A mix of music and comment, mostly about the joys of the weekend vs. the drudgery of the workplace. Lots of shouts of "Friday!" and "It's the weekend!" "We're going to drain your mind of the mental paralysis of the weekend grind."

WMPR, heard by Pearce on 6955 at 1805, with what Dick describes as "an incredible roller coaster signal." Many pretty instrumental tunes, none announced. Closed by saying "Greetings KNBS and all the other pirates on the frequency. This is WMPR with a test transmission. Goodbye from WMPR." No address given.

Would you guess that 6955 is the place to park your dial these days if you want to hear pirates? I think this is the first time that all the logs were on one frequency, give or take a few tenths. There were a lot of unidentifieds this month but no room to fit them in. Sorry.

Keep those great reports headed my way! QSL copies also are needed for use as illustrations. Thanks! ■

Synchronous AM !

Greatly improve reception with the time-proven High-Fidelity SE-3 MK III product detector. Eliminates selective-fade distortion and garbling through phase locked synchronous detection. Can receive one sideband at a time to minimize interference.

All radios adaptable to SE-3 external detector / amplifier. Presently used with Collins, Drake, Icom, JRC, Kenwood, Racal, and Watkins-Johnson. SE-3s start at \$449.00.

New R-9000 6, 4, and 3 kHz AM filter modifications !

Racal & JRC filters: 16, 8, 6, 3.5, 2.1, 0.4, 0.25 KHz.

New JRC & SE-3 Mk III package or used JRC, Kenwood, Icom, or Racal available with SE-3 Mk III.

Sherwood Engineering Inc.

1268 South Ogden Street
Denver, CO 80210
(303) 722-2257, FAX (303) 744-8876

CIRCLE 72 ON READER SERVICE CARD



Restores Horizontal and Vertical Sync Lines from Distorted Analogue Video Formats

For Free Information Package on Completed Units and Pricing

• Call Toll Free •

1-800-236-5778

R.C. Distributing • PO Box 552 • South Bend, IN 46624

CIRCLE 67 ON READER SERVICE CARD

ANNOUNCING

\$3.95

CB Radio
1996 BUYER'S GUIDE

NEW!!

The ONLY nationally distributed CB publication

POPULAR COMMUNICATIONS CB Radio Buyer's Guide

EXCLUSIVELY for CB enthusiasts, whether you're just getting started in CB or you're an old-timer, this is the Guide for YOU!!!!

ARTICLES • PRODUCTS • PHOTOS • DEALERS

Be part of the CB scene—if you've got a CB, this is YOUR Buyer's Guide—chock full of how-to articles from antenna installation and safety, to getting the most from your CB.

We've got the U.S.A.'s CB authorities—Tom Kneitel, Jock Elliott, Ron McCracken, Bill Price and many others all IN ONE BIG CB Buyer's Guide! They'll tell you how to be part of the fun, safety and security CB brings everyone!

++FULL CB PRODUCT LISTING++

All the CB transceivers; base, mobile and walkie-talkies, many with photos - ALL with suggested retail prices - AND dozens of miscellaneous accessories, from antennas to microphones to complete your CB installation!

Articles and photos on:

- Tips on getting AND giving help on Channel 9
- Buying a CB — What You Need To Know
- Packing A Punch, Legally — All About Gain and Antennas
- Sideband — Your Ticket to Increased Range and More Fun
- AND MANY MORE

\$3.95 at your CB dealer or newsstand
(add \$2.50 shipping and handling for mail or phone orders)

Mastercard, VISA, American Express, Discover accepted.
Send card number and expiration date with order.

BONUS information AND product listing. GMRS, The General Mobile Radio Service: Serving your community in time of need.

\$3.95 at your CB dealer or newsstand
(add \$2.50 shipping and handling for mail or phone orders)

Mastercard, VISA, American Express, Discover accepted.
Send card number and expiration date with order.

Articles and photos on:

- Tips on getting AND giving help on Channel 9
- Buying a CB — What You Need To Know
- Packing A Punch, Legally — All About Gain and Antennas
- Sideband — Your Ticket to Increased Range and More Fun
- AND MANY MORE

Popular Communications

76 N. Broadway, Hicksville, NY 11801. FAX 516-681-2926 For Fastest Service, Order Toll Free (800) 853-9797

Satellite-Direct Weather Fax

All emergency mobile communications vehicles should have a dedicated, inexpensive computer for weather facsimile reception. System requirements are minimal: IBM compatible (386 and up); 640 KB RAM; hard disk preferred; CGA, EGA, VGA or Hercules graphics; serial port (COM 1 to COM 4).

As you can see, almost any type of tabletop or laptop computer can serve as a weather facsimile receiver.

There are three ways to receive weather facsimile satellite imagery and weather forecaster charts over the air. Mariners prefer high-frequency weather facsimile reception because many weather officials draw out important ocean wind and weather

forecasts found on weather charts by hand. You need a 3-30 MHz SSB receiver to capture these long-range broadcasts.

But for disaster communication teams going into areas of the United States decimated by a catastrophic storm or other type of disaster, direct satellite weather facsimile reception is preferred.

Polar orbiting satellites, called low earth orbit satellites, circle the earth from north to south up about 500 miles, giving incredible infrared and visible light images of the earth with resolution showing features as small as 1 kilometer! A typical pass will offer an image covering 2,500 by 1,500 miles, and you get between four and six shots a day on and around 137.5 MHz.

Your receiver is a modified wide-band scanner on 137.5 MHz, tied into a VHF antenna that offers gain up to the sky.

The antenna technically is called a quadrifilar helix, and is optimized for overhead polar satellite reception with an internal 8-dB GaAsFET preamplifier. Your total receiver-antenna cost is about \$300, plus another \$200 for the computer program and the tiny analog-to-digital COM port plug. The program also contains a map generator that will create a map of any scale centered anywhere on earth, so you can spot latitude and longitude lines for easy reference. Because this is real-time imagery, you can spot incoming weather systems that could be a threat to your ongoing

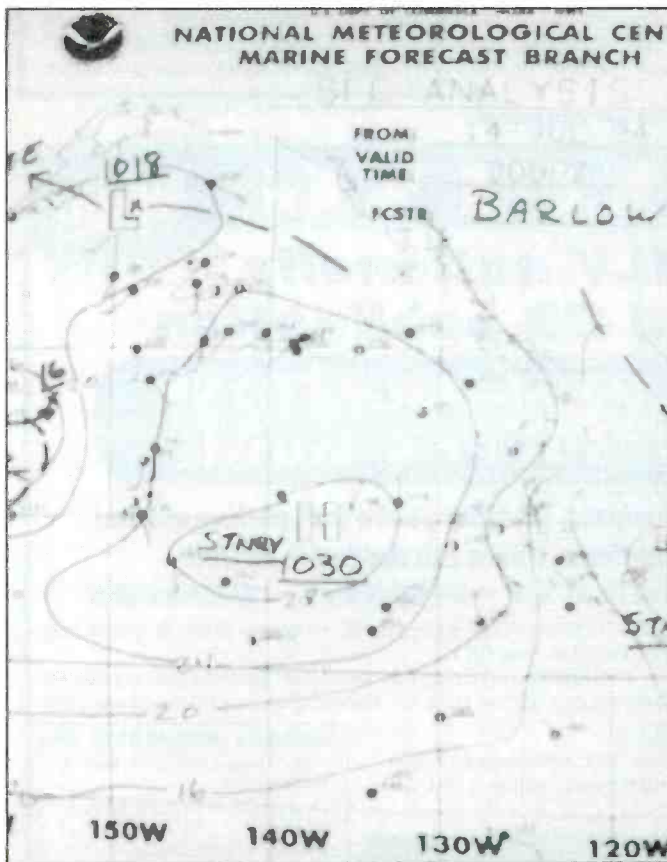

Weather as received on 4.1 MHz high frequency.

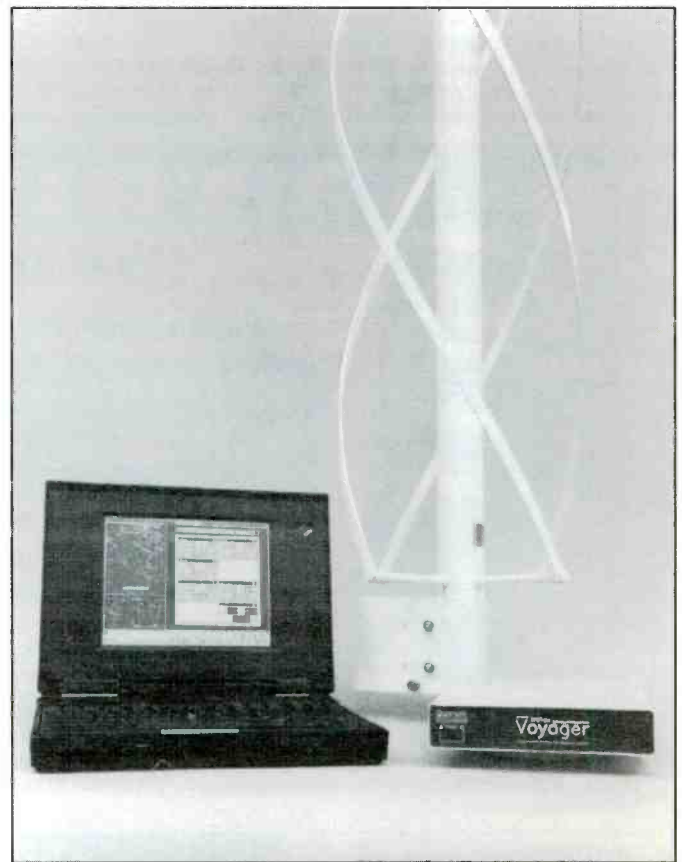

Shown are a 137.5 MHz polar satellite receive antenna and software program.

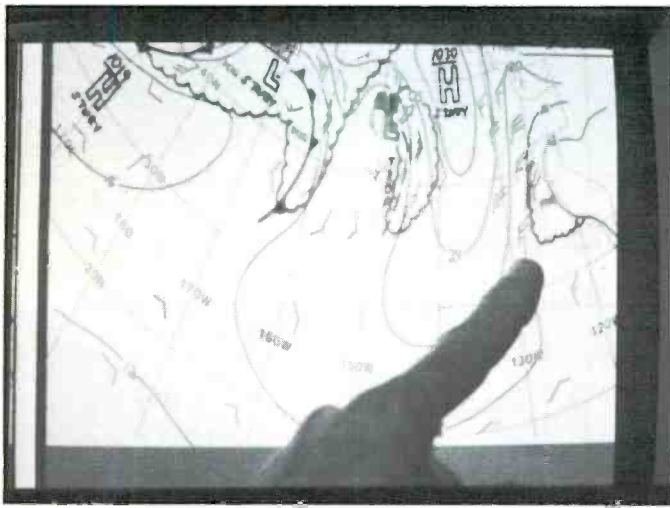

Notice the fog band displayed on this 1691 MHz weather fax imagery.

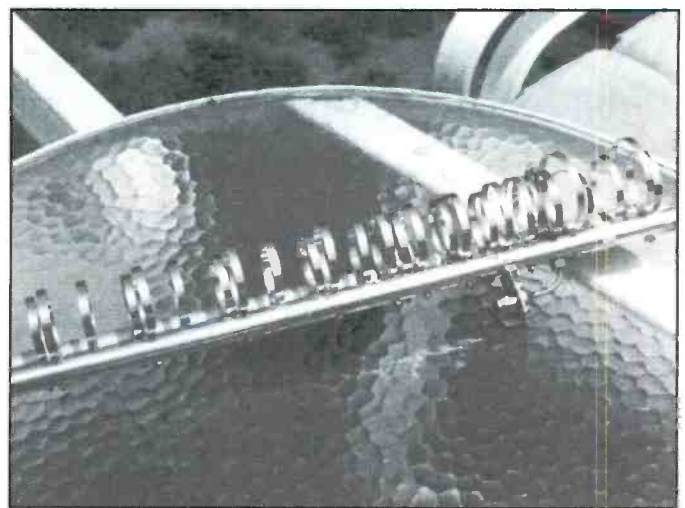

A loop Yagi for 1691-MHz reception.

ing emergency operations program.

The third way to receive weather facsimile imagery is from geostationary satellites that transmit in the S-band microwave region at 1691 MHz. These satellites send a complete image every five minutes, and about every hour you get a couple shots of the visible weather plus infrared imagery over the United States. Five minutes later, you're looking down at the Red Sea, then Japan, Asia, then the Sahara Desert, and about 50 minutes later, here come two more shots of the weather over the United States, along with superimposed geographic state borders.

Two geostationary weather satellites serve us: one parked at 75 degrees west and a new one, GOES 9, parked at 135 degrees west. The United States comes in from two different perspectives, and the resolution is so clear that if you spot a cloud on your screen, you can even see it when you step outside of your emergency communications command post.

At 1691 MHz, we use a loop Yagi that is easily aimed and fixed at either satellite. Critical positioning to tune in the geosynchronous satellite is not required, but the antenna must be aimed at the bird. The loop antenna is about \$150, but the big expense is in the downconverter from Quorum that takes 1691 MHz and down-converts it to that wide-band scanner at 137.5 MHz. The scanner then outputs to the analog-to-digital plug that goes into your computer. You also may want to check into OFS WeatherFAX for capturing weather satellite imagery. Among much merchandise, look into the company's PCMCIA-convertible capture board and full-function software. Call or fax (919) 847-4545 for more information.

Quorum Communications, 8304 Esters Blvd., Suite 850, Irving, Texas 75063, (800) 982-9614 is one of the biggest pro-

ducers of weather facsimile equipment for emergency communications centers. They even have a "big board" computer system where the receiver actually is built on the board that fits inside of larger computers. For laptops, the 137.5 MHz output is from a dedicated wide-band modified scanner to accept the wider bandwidth of a normal narrow-band FM signal.

Three of the most popular low-priced systems are available from Software Systems Consulting in San Clemente, Calif., at (714) 498-5784; AEA in Lynwood, Wash., at (800) 432-8873; and from MFJ in Mississippi, at (800) 647-1800. They have individual or combined programs that can work on high-frequency weather facsimile reception, VHF direct satellite polar-orbiting reception at 137.5 MHz, or geosynchronous 1691 MHz satellite down-converted to 137.5 MHz satellite

reception capabilities.

Forecasting the weather by observing incoming storm fronts is important to emergency personnel working a disaster area. Weather facsimile also can spot threatening conditions where cold and warm fronts might collide over your disaster-working area. If your computer has color, you even can determine storm level altitudes to judge whether or not the potential of tornadoes exists. Hurricanes stand out clearly and can be stored on the hard drive as a freeze-frame progression of active weather updated every hour.

Your onboard computer—laptop or fixed—is the main part of your weather forecast station. Add a receiver and antenna, and you are ready to produce detailed weather imagery charts. The signals are out there on the airwaves right now, so take advantage of them. ■

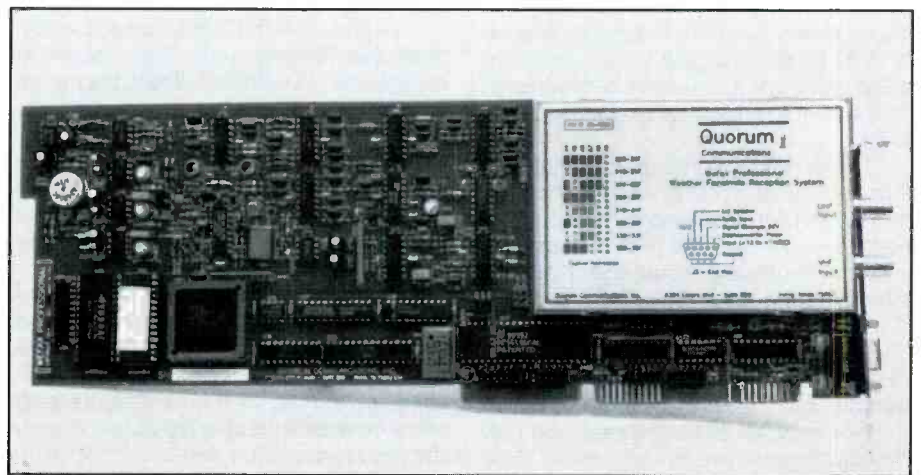

Here is the technology behind the Quorum 1691 MHz weather fax receiver, and 137.5 MHz for regular-sized computer systems.

Scanning VHF/UHF

BY J.T. WARD

MONITORING THE 30 TO 900 MHz "ACTION" BANDS

Tune In Airliner En Route Frequencies

As a Cessna Skyhawk driver, I particularly enjoyed receiving a letter from Donald R. Richmond, an MD-80 pilot for Alaska Airlines.

Don included a copy of the ARINC-1 chart from Jeppesen Sanderson Inc., the aviation chart company.

The ARINC-1 chart is a map of the United States showing the primary VHF airband frequencies used by Aeronautical Radio Inc. (ARINC) to communicate with commercial airliners flying from city to city.

Don also offered the following great explanation of why and when air crews use these frequencies: "Normally, upon reaching cruise altitude, a crew will switch from the local company frequency at the departure airport to an "appropriate" ARINC or company en route frequency.

"Federal regulations say this en route frequency must enable two-way communications between the aircraft and the company's dispatch office.

"When scanning in your local area, the communications you normally hear on an airline company frequency are between the aircraft and the local station operations office, which is not the same as the company's dispatch office.

"Each airline has one central dispatch office from which all flights for that airline actually are dispatched, in the sense that a certified dispatcher has completed all the necessary computations (fuel, weather information, etc.) and put the necessary info into a system (usually a company computer link) to get it to the local operations office, where it is reviewed and accepted by the pilot in command of that particular flight.

"Under Federal Aviation Regulation Part 121 (which covers all airline operators except for smaller commuter operations), two people—the pilot in command and the dispatcher—must agree on certain operating parameters for any particular flight.

"They must agree on minimum fuel, destination weather, alternate airport weather and a number of other factors.

"Normally, all this is 'canned' and only changes necessitated by daily events enter to change the dispatch, i.e., if the weather is really good you may be dispatched without an alternate airport and thus can go with less fuel; or, if the weather is really bad

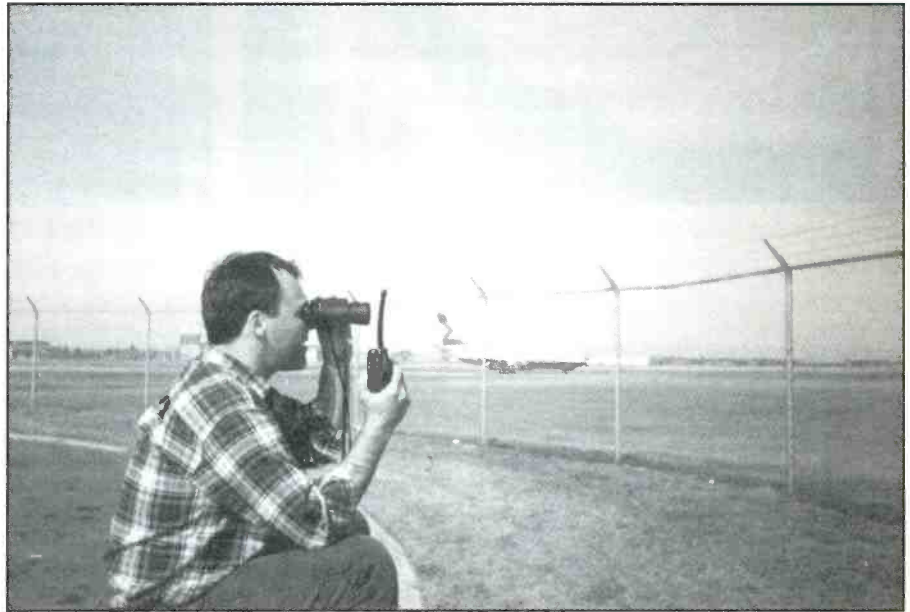

Binoculars and scanner in hand, Trevor Fletcher watches and listens as a Canadian Airlines Boeing 737 taxis by at the Edmonton (Alberta) Municipal Airport.

your alternate may be so far away that a substantial increase in fuel is required.

"The bottom line to all this is that both people are involved in the planning and execution of every flight, and both must agree to any changes that occur after take-off.

"It is this dispatch office that also maintains the FAR-required flight following capabilities, to inform a flight that is en route of any significant changes to the original dispatch.

"It is primarily for this en route flight following that ARINC is used, however that does depend on the individual airline. Some maintain their own radio network that conforms to their particular route structure.

"Prior to working for Alaska Airlines, I flew for Eastern and they had their own en route network. Often the local frequency was the same as the en route frequency. As long as the central dispatch office can reach the aircraft while en route, the requirements are met.

"ARINC simplifies the operation in the sense that if the dispatch office needs to reach the aircraft, they call ARINC, give the wanted aircraft's SELCAL code, and

ARINC will get the flight on the radio and patch the radio communications over the phone line back to the dispatcher.

"Of course, this works just as well going from aircraft to dispatcher (or maintenance, if that is the case). The pilots call on the ARINC frequency and request a patch to their company dispatcher (or maintenance base) and in seconds they are talking with the people they need.

"If you recall the crash of the United Airlines DC-10 at Sioux City, Iowa, several years ago, that crew spent a good deal of time talking with in-flight maintenance through an en route patch via ARINC, trying to get help solving a problem that never was supposed to happen.

"Most communications en route are out of the ordinary, but certainly not like that. Weather problems, mechanical problems and medical emergencies make up most of it. The most unusual one I have heard was a Continental Airlines captain getting a patch to his crew scheduling, informing them that when he landed at Los Angeles International Airport he was going to retire right then and there and for them to get someone else for the return leg.

"Direct communications with the dispatch office via ARINC is not usually the case when the aircraft can talk to a local operations office for their airline.

"But if it were a difficult situation, one where direct communications from the aircraft to the dispatch office was needed to be able to deal with the situation, and not use a third party as a message relay, ARINC would have been used.

"A maintenance problem would be an example of such a situation. Use of a third party relay who is not conversant with the technical details of the problem can be a problem all by itself."

Don, this chart's a real keeper, and I'm adding it to the reference material I keep handy next to my radios in a three-ring binder.

ARINC's nationwide radio coverage is provided by a network of remote transmit-receive sites. Because the radio operators are located in ARINC's San Francisco headquarters, air crews normally use the hail "San Francisco Radio" when calling ARINC.

Here's a list of the frequencies shown on the chart for Aeronautical Radio Inc.'s en route VHF frequencies (all in MHz, AM mode): 131.300, 131.650, 129.400, 129.850, 129.450, 130.200, 131.800, 130.400, 129.350, 128.900, 130.800, 130.700, 130.425, 131.950, 131.175 and 129.900.

Because these frequencies are in use by aircraft flying above 20,000 feet, communications often can be monitored from hundreds of miles away.

Rapid City Freqs, Fast!

Brian Mitchell of Rapid City, S.D., attended a summer air show at Ellsworth Air Force Base and was lucky enough to get a peek inside the Rapid City-Pennington County Mobile Command Post, which was on display.

Brian says the command post is equipped with VHF and UHF radios, and the VHF rig has more than 70 channels preprogrammed, including frequencies for the sheriff and fire departments for all the adjacent counties, for federal marshals, the U.S. Forest Service, some military installations and even a few channels from neighboring Wyoming.

A new frequency in use in the Rapid City area is the Sheriff's Office mutual aid frequency of 155.670 MHz. According to Brian, this frequency is cross-banded to 453.800 MHz, which is used by Rapid City police.

Other Rapid City area frequencies include Rapid City police on 453.900, 453.100, 453.650, and 453.950; and the Sheriff's Office on 155.670, 155.610, 155.550 (primary), 158.790, 155.670 and 155.310.

Brian must be a real aviation buff, since he also attended the Reno Air Races.

Brian, I'm jealous. I've been to a lot of air shows, but that's one I've always wanted to see, and never have. Love those Mustangs!

But if I ever get the chance to go to Reno, you can bet that thanks to Brian my scanner will be loaded with the following frequencies: control tower, 126.400; ground control, 121.050; air-to-air, 123.450; PA system, 122.725; and automated weather on 135.175 MHz.

Yosemite Scan

"Big Bill" of Bakersfield, Calif., found himself in the middle of the action recently when during a vacation trip to Yosemite National Park he discovered that park rangers were searching for a fugitive who assaulted a female ranger. Bill says other rangers were fighting a 200-acre forest fire in the park at the same time as the search.

"My old Pro-37 scanner almost jumped off of the table as frequencies opened up, one after another," Bill wrote.

He sent along the following frequencies for Yosemite National Park: firefighters, 172.775, 172.650 and 163.100; law enforcement, 166.300, 168.350, 166.350 and 166.850; park buses, 154.515; maintenance crews, 151.805; and housekeeping staff, 164.425, 164.525, 164.725 and 164.475.

According to a newspaper clipping Bill included with his letter, the fugitive finally was caught following a 12-day manhunt.

Untangled Web

I received e-mail this month from Mike Odon who reminded me there still are scanner listeners who haven't discovered the Internet as a great place to find radio-related information.

Mike suggests the following Internet World Wide Web sites as good places to start browsing: <http://www.kaiwan.com/~smakk/freqs.html> (for frequencies for hotels, casinos and theme parks), <http://www.eng.hawaii.edu/Contribs/carina/nascar/mis> (for NASCAR racing frequencies), <http://www.eng.hawaii.edu/Contribs/carina/indycar/mis> (for INDYCAR racing frequencies), <http://128.174.5.59/~roma/rr-freqs.html> (for railroad frequencies), and <http://www.scanner.org/> (for great links to many other pages).

Cary Calling

An interesting letter came from David Bench in Cary, N.C.

"I have been monitoring public safety frequencies since I was about 6 years old. In those days, the Syracuse, N.Y., Police Department operated on 1050 kHz in what is now the AM broadcast

band. I would listen for my dad.

"Later, they upgraded to 39.98 MHz. In the early 1970s, they went to UHF in the 460-MHz area.

"I have long since moved away, first to Jamestown, N.Y., then to San Diego, and I'm now in Cary, N.C. I've kept up my hobby, now using a RadioShack Pro-39 and an AOR AR-1000. I also use a Regency HX1200 I got in San Diego. I've been buying POP'COMM on and off for about five years and I enjoy the information. I've been in the telecommunications business for over 30 years."

David asked about becoming a registered monitor. You can find out about becoming a registered monitor by writing to CRB Research Books Inc., P.O. Box 56, Commack, NY 11725-0056. The distinctive callsign-looking identifier can be used in your correspondence with radio facilities. It doesn't give you transmitting privileges, but it does acknowledge you are an active listener.

Unmobile Antenna

A question that comes up regularly is how to improve the reception of scanners (and shortwave radios, too, for that matter) used in mobile homes where outside antennas are restricted.

Twelve-year-old Christopher Riggs of Edwardsville, Kan., has rigged up a set of antennas he says is both unobtrusive and effective.

"For VHF/UHF work, I have a Kenwood RZ-1. This radio runs seven days a week, and is the definition of reliability," Chris writes.

"For an outside antenna, I took a Pro-AM Valor SS-100MOT mirror mount and bolted this to the side of the mobile home as close to the roof as I could.

"To this, I added an Austin Spectra 30-800 MHz mobile antenna. The Austin comes with a 14-inch whip, but I discarded this and added a 21-inch top whip that gives good reception from CB through 900 MHz," he said.

For added stealth, Chris says he paints all of his antennas flat black. He said the paint doesn't seem to affect the antenna's performance.

Write In

Well, that about wraps it up for this month, folks. Keep those cards, letters and pictures coming, and please be sure to let me know your city and state, especially those of you who write via e-mail.

Send your letters to J.T. Ward, Scanning VHF/UHF, Popular Communications, 76 N. Broadway, Hicksville, NY 11801-2909. GENie online subscribers may contact me directly by addressing e-mail to JTWard. Send e-mail via the Internet to JTWard@genie.com ■



CQ BOOK &

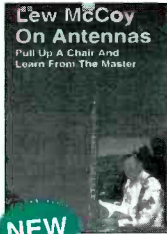

NEW

McCoy on Antennas

CQ magazine author and acclaimed authority on antenna theory and design, Lew McCoy, W1ICP, has written a truly unique antenna book that's a must for every amateur. Unlike many technical publications, Lew presents his invaluable information in a casual, non-intimidating way. **Lew McCoy on Antennas**—It's not just an antenna handbook, but a wealth of practical antenna advice for the ham! **Order No. MCCOY.....\$15.95**

Building and Using Baluns and Ununs

Written by world-renowned expert Jerry Sevick, W2FMI, this volume is the definitive source for his latest practical information and designs on transmission line transformer theory. W2FMI has unraveled the technological mysteries with designs that are simple and work. Discover new applications for dipoles, yagis, log periodics, beverages, antenna tuners, and countless other examples. **Order No. BALUN.....\$19.95**

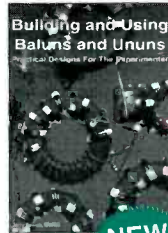

NEW

The NEW Shortwave Propagation Handbook

The most comprehensive source of information on HF propagation is available from CQ! We've built an award-winning team, gathering information from individuals and organizations around the world. Collectively, co-authors George Jacobs, W3ASK, Ted Cohen, N4XX, and Robert Rose, K6GKU, have devoted much of their professional and amateur careers to advancing ionospheric science. Propagation principles, sunspots, ionospheric predictions, photography, charts and tables galore—it's all in this unique reference volume! **Order No. SWP....\$19.95**

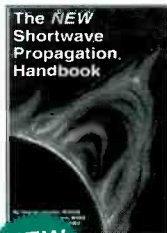

NEW



The Quad Antenna

Hams love antenna books. Written by noted author Bob Haviland, W4MB, **The Quad Antenna** is the authoritative technical book on the design, construction, characteristics and applications of quad antennas. Discover how to easily build a quad antenna for your station that will help you fill your logbook with rare DX that you've only dreamed about before. **Order No. QUAD..... \$15.95**



The Packet Radio Operator's Manual

This book is written by CQ columnist and Amateur Radio Packet authority Buck Rogers, K4ABT. An excellent introduction and guide to packet operation, it is the perfect single source, whether you're an advanced user or just starting out. Learn about packet radio without all the technical jargon. This book is the definitive resource for the active packet user. **Order No. PROM..... \$15.95**

Order No. PROM..... \$15.95

CQ Buyer's Guides

Dealers • Manufacturers • Product Specs • Feature Articles • Equipment Prices



NEW

1995 Beginner's Guide to Amateur Radio

Whether you're a Novice, Technician or just beginning to think about getting your license, CQ's Beginner's Guide is the perfect addition to your shack. In addition to practical articles on HF, DXing, building your first station, QSLing, and more, you'll also find our famous dealer and manufacturer's listings! **Order No. 95BBG....\$5.95**

Order No. 95BBG....\$5.95



1996 Equipment Buyer's Guide

Learn from the experts about the latest features in HF/VHF gear, choosing the best antennas and reaching the top of amateur licensing. Our 1996 Equipment Buyer's Guide is a package of solid information including the latest in amateur dealers and manufacturers. Discover why this year's edition is the best yet! **Order No. 96EBG...\$5.95**

edition is the best yet!

Order No. 96EBG...\$5.95

CQ's Buyer's Guides are the single source for information on what equipment is available, features and functions, and where to buy it!

We carry all ARRL products

Now Available Direct From CQ!

Title	Order No.	Price	Title	Order No.	Price
ARRL Antenna Book	ARRLAB	\$30	ON4UN Antennas and Techniques for Low Band DXing	LOWDX	\$20
ARRL Handbook (1996 Ed. w/software)	ARRLHB	\$38	1996 NA Callbook	NACB	\$35
ARRL Operating Manual (New Edition)	ARRLOM	\$22	1996 Int'l Callbook	INTCB	\$35
ARRL Repeater Directory ('95-'96)	ARRLRD	\$7	1996 Callbook Pair	NAICB	\$65
ARRL Antenna Compendium Vol. 1	ARRANT1	\$10	1996 Callbook on CD-ROM (New)	CB CD	\$49
ARRL Antenna Compendium Vol. 2	ARRANT2	\$12	Gordon West No-Code Technician Plus License Manual	GWTM	\$10
ARRL Antenna Compendium Vol. 3	ARRANT3	\$14	Gordon West General License Manual	GWGM	\$10
ARRL Antenna Compendium Vol. 4	ARRANT4	\$20	Gordon West Extra License Manual	GWEM	\$10
ARRL Weather Satellite Handbook	ARSAT	\$20			
ARRL FCC Rule Book	ARFCC	\$9			
ARRL World Map	ARMAP	\$12			

VIDEO LIBRARY

Keys, Keys, Keys

Enjoy nostalgia with this visual celebration of amateur radio's favorite accessory written by CQ's Dave Ingram, K4TWJ.

Order No. KEYS.....\$9.95

The VHF "How-To" Book

This book is the perfect operating guide for the new and experienced VHF enthusiast as only Joe Lynch, N6CL, can describe.

Order No. BVHF.....\$15.95

Ham Radio Horizons: The Book

This is an excellent book for the beginner or for use in your club's licensing classes. HRH, by Peter O'Dell, WB2D, is full of information about all phases of ham radio and how to get started.

Order No. BHOR.....\$12.95

The Vertical Antenna Handbook

Take advantage of the 20 years of research and practical experience of naval communications engineer Capt. Paul H. Lee, USN(ret), N6PL. Learn basic theory, design, and practice of the vertical antenna. Discover easy construction projects such as a four-band DX vertical or a broadband array for 80 meters. Paul Lee can get you started today!

Order No. VAH..... \$9.95



All Videos Available in PAL format

Getting Started in Ham Radio

This is a fast-paced video introduction to the fascinating world of ham radio. CQ's experts show how to select equipment and antennas; which bands to use; how to use repeater stations for improved VHF coverage; the importance of grounding and the basics of soldering. Get the most out of your station, whether it's home-based, mobile or hand-held.

Order No. VHR\$19.95

Getting Started in Packet Radio

This video will help de-mystify the exciting but sometimes confusing world of packet radio. Learn how to get started using your computer on the radio. Included are step-by-step instructions on making packet contacts and using packet bulletin boards, networks and satellites.

Order No. VPAC.. \$19.95

Getting Started in Contesting

For the newcomer to contesting or an experienced veteran, this video is for you! You'll get advice and operating tips from some of contesting's most successful competitors, including Ken Wolff, K1EA, Dick Newell, AK1A, and CQ's own contest columnist, John Dorr, K1AR. Here's just a sample of what you'll see: what contesting's all about, explaining contest jargon, tips for beginners, how to compete from a small station, operating secrets from the "pros", live QSOs from world-class stations, and VHF/UHF contesting.

Order No. VCON\$19.95

Getting Started in Amateur Satellites

Learn with this video how veteran operators set up their satellite stations. Find out how to locate and track ham satellites with ease. Watch as operators access current satellites and contact far ranging countries around the world. This video is filled with easy to understand advice and tips that can't be found anywhere else.

Order No. VSAT..... \$19.95

Getting Started in DXing

Top DXers share their experience with equipment, antennas, operating skills, and QSLing. You'll see hams work rare DX around the world. If you're new to DXing, this video is for you! All this valuable information may well give you the competitive edge you need to master the world of DXing.

Order No. VDX..... \$19.95

Getting Started in VHF

This is the ideal introduction to VHF. See demonstrations of the latest radios. Also, learn about repeater usage as well as the more exotic VHF operating modes. Whether you are interested in packet radio, satellite operation, or simply using your local repeater, this is your video!

Order No. VVHF....\$19.95

Ham Radio Horizons: The Video

This introduction to Amateur Radio is an excellent complement to the Ham Radio Horizons book. Enjoy seeing all aspects of ham radio ranging from what it takes (and costs) to get started to how you can get your ham license. HRH is ideal for public events, presentations to community groups and as an opening to your club's licensing courses!

Order No. VHOR.....\$19.95

Order Toll-Free 1-800-853-9797

YES! I want to learn from the experts. Rush me my book(s), video(s), buyer's guide(s) right away!

Please add \$4 shipping & handling. **FREE shipping & handling for orders \$50 and over.**

Please make your check or money order payable to: CQ Communications, Inc.

Qty	Item #	Description	Price	Total Price
Shipping/Handling				
NY State Residents add applicable sales tax.				
Total				

Name _____ Callsign _____

Address _____

City _____ State _____ Zip _____

MC/VISA/AMEX/Discover # _____ Expires _____

Form of payment: MC VISA AMEX Discover Check Money Order

Please mail your orders to:  **CQ Communications, Inc., 76 North Broadway, Hicksville, New York 11801-9962** FAX 516-681-2926

**FREE
SAMPLE
COPY!**

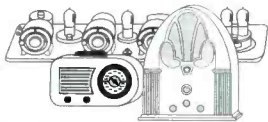

ANTIQUE RADIO CLASSIFIED

*Antique Radio's Largest-Circulation
Monthly Magazine*

Articles - Classifieds - Ads for Parts & Services

Also: Early TV, Ham Equip., Books,
Telegraph, 40's & 50's Radios & more...

Free 20-word ad each month. Don't miss out!

1-Year: \$34.95 (\$51.95 by 1st Class)

6-Month Trial - \$17.95. Foreign - Write.

A.R.C., P.O. Box 802-T10, Carlisle, MA 01741

Or Call: (508) 371-0512



**Get online
with ES&T
on Genie®**

*Look for us in the Radio &
Electronics Roundtable*

To join Genie, use your computer &
modem to call 1-800-638-8369.

At the **U#**= prompt, type **JOINGENIE**

And for a special introductory offer,
At the **key/offer code** prompt,
type **MEG528**

CIRCLE 60 ON READER SERVICE CARD

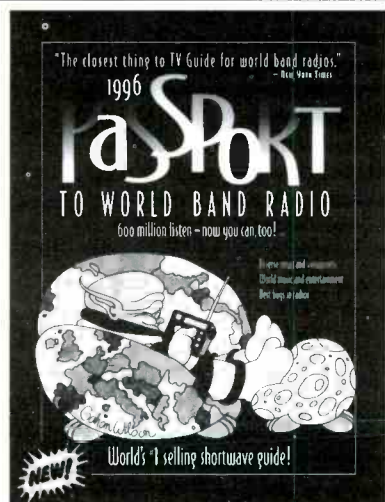

Here's the latest on equipment, accessories and radios for SWL'ing. ©1995

IBS-RDI96 **\$19.95** plus
shipping \$4.50 US Mail - \$7.50 Foreign

Free Catalog Packed with all kinds
of books for Amateur Radio, SWL,
CB and electronics professionals.

(800) 457-7373

Radio Bookstore

PO Box 209
Rindge, NH 03461-0209

603-899-6826 24 hour FAX



Communications Shop

Advertising Rates: Non-commercial ads are 30 cents per word, including abbreviations and addresses; minimum charge \$6.00 per issue. Ads from firms offering commercial products or services are \$1.00 per word; minimum charge \$20.00 per issue. Boldface words are \$1.20 each (specify which words). Leading key words set in all caps at no additional charge. All ads must be prepaid in full at time of insertion; a 5% discount is offered for prepaid 6 time insertions. All ads must be typewritten double spaced.

Approval: All ad copy is subject to Publisher's approval and may be modified to eliminate references to equipment and practices which are either illegal or otherwise not within the spirit or coverage scope of the magazine.

Closing Date: The 10th day in the third month preceding date of publication. Because the advertisers and equipment contained in Communications Shop have not been investigated, the Publisher of Popular Communications cannot vouch for the merchandise listed therein. Direct all correspondence and ad copy to: PC Communications Shop, 76 N. Broadway, Hicksville, NY 11801.

Please take note: As of May 1, 1995, we are no longer accepting free subscriber ads.

CB RADIO OWNERS AND DEALERS. A new line of accessory circuits is now available. Breaker Beeper, Receiver Pre-Amplifier, Roger Beeper, many more—some never before available! Send an S.A.S.E. for a free catalogue to 6810 7th Street, N.E., Tacoma, WA 98422.

TOMCAT'S BIG CB HANDBOOK, by Tom Kneitel. 221 large pages, fully illustrated. Complete guide to worldwide AM, SSB, Freeband, 27 MHz operations. Everything they never told you (legal & otherwise) from world's leading CB authority. Only \$15.95 plus \$5.00 s/h (Canada \$6.00) from CRB Research Books, Inc., PO Box 56, Commack, NY 11725. (NYS residents add \$1.78 sales tax).

WORLD'S MOST UNUSUAL Communications Books! A large selection of outstanding titles covering scanners, "confidential" frequency registries, bugging, wire tapping, electronic surveillance, covert communications, computers, espionage, monitoring, and more! New titles being added constantly! Ask for our big FREE catalog. CRB Research, BOX 56-PC, Commack, NY 11725.

LOOKING FOR crystals for Drake 2B receiver. Also need information on restoring cellular capacity to Realistic Pro-46 scanner. Sue Wilden, 2204 6th Street, Columbus, IN 47201.

COMMODORE 64 HAM PROGRAMS—8 disk sides—over 200 Ham programs—\$16.95. 32¢ stamp gets unusual software catalog of Utilities, Games and British disks. Home-Spun Software, Box 1064-PC, Estero, FL 33928.

RCI-2950/2970 MODIFICATION MANUAL. Power and modulation increase. Clarifier, receiver, noise blanker modifications, operating hints, and more. Parts included, \$20 ppd U.S. money order, \$25 COD (MO residents add \$1.15 tax). Scott, P.O. Box 510408, St. Louis, MO 63151-0408, (314) 846-0252.

NEW AWARDS PROGRAM! For SWL's, DX'ers, Scanner Buffs! Self-addressed stamped envelope brings details! ISWAC, Box 66, Hanover, MI 49241.

RADIO SHACK SCANNERS, PRO-2035, PRO-62 handheld, used very little, like brand new, three extension speakers, two headphones, two battery chargers, NiCad batteries, frequency manuals, books, \$375. Ernie, 702 Merritt Court, Sonoma, CA (707) 938-0879.

TUNE In On Telephone Calls! New 3rd Edition, by Tom Kneitel. Latest freqs., info., and effective scanner accessories for serious recreational eavesdropping on cellular, 46 and 900 MHz cordless, air/ground phones, digital pagers and more. The original, official, controversial 160-page source book, now updated! Only \$16.95, plus \$5 s/h (\$6 to Canada). NY State residents add \$1.81 tax. Order from your favorite dealer or CRB Research Books, Inc., P.O. Box 56, Commack, NY 11725. MC/VISA accepted. Phone orders 1-800-656-0056. Canada/AK/HI orders: (516) 543-9169.

NTR-1 DSP NOISE/TONE REMOVER, new. I paid \$169.95; yours for only \$95. Send money order to Yassin Abdela, Two Riverside Street, Rochester, NY 14613. Call (716) 254-0940 before mailing check.

WANTED: USED OPTOELECTRONICS APS104 PRESELECTOR. FOR SALE: OPTOELECTRONICS CF800 8355 MHz Filter/Amp. Brent Gabrielsen, 1177 East Tonto, Apache Junction, AZ 85219. (612) 969-8663.

MORSE CODE Got You Down? Why let a mental block stand between you and upgrading? Use Alternative Art's **CW Mental-Block Buster to blast through those barriers.** Just follow the instructions for 30 days—Results Guaranteed! Based on 40 years of research, the **CW Mental-Block Buster** uses guided meditation, dynamic visualizations, and powerful affirmations to blast through mental blocks. **You can do code!** That means new bands, more contacts, more fun! (This is not a CW practice tape.) The **CW Mental-Block Buster** audio cassette and practice booklet are only \$25.95 ppd. in the US. **Alternative Arts,** 4601 Rosemare Rd., Parkersburg, WV 26101. (304) 422-2767. MC/VISA, COD. Mail orders include signature. Office hours after 4:30 Eastern.

THE GE SUPERADIO III with up to four modifications is choice for many DX'ers. Low as \$85. MC, VISA, 800-944-0630.

SATELLITE RADIO BOOK AND GUIDE. New book covers all Audio Services, SCPC, Subcarriers, FM Squared, Facsimile, Press Services, Weather Services. Simple how-to-receive instructions, \$16.95, plus \$3 Priority Mail. **UNIVERSAL ELECTRONICS,** 4555 Groves Road, #12, Columbus, OH 43232, or call (614) 866-4605.

SCANNER WORLD, USA®

"The Largest Dealer of Scanners in the World"



10 New Scotland Ave., Albany, NY 12208

518-436-9606

**Est. 1967
Same Location
Over 20 years**

Featuring Uniden Bearcat Scanners, CB Radios, Reim Two Way Radios, Complete Line Of Accessories, Antennas, Rechargeable Batteries, Books, Power Cords, Carry Cases.



Model #	Scanner World Price	Shipping Each
BEARCAT		
BCT7	199.99	7.00
BC60XLT	109.99	7.00
BC70XLT	99.99	7.00
BC80XLT	174.99	8.00
BC120XLT	139.99	7.00
BC144XL	79.99	7.00
BC148XLT-1	96.99	7.00
BC150B Black	159.99	8.00
BC150Y Yellow	159.99	8.00
BC170XL	99.99	7.00
BC178XLT	134.99	7.00
BC220XLT	239.99	8.00
BC560XLT	82.99	7.00
BC700A	199.99	7.00
BC760XLT	249.99	7.00

Model #	Scanner World Price	Shipping Each
BEARCAT		
BC350A	94.99	7.00
BC400XLT X	93.99	7.00
BC855XLT	149.99	8.00
BC860XLT	149.99	8.00
BC890XLT	259.99	9.00
BC3000XLT	374.99	10.00
BC8500XLT	299.99	10.00
BC9000XLT	394.99	10.00

**All Scanners In Stock
for Same Day Shipping**

**Full Line Catalog
Mailed 5 Times
A Year!**



\$159.99



\$39.99

**GRE
800 MHz
Converters
-IN STOCK-
Call For Price**

**CALL FULL LINE
SCANNER CATALOG**
The only catalog devoted specifically to scanners in the USA. Large 56 pages with all the information you need!

Internet address: <http://www.scannerworld.com>

—IF YOU CAN'T FIND WHAT YOU WANT, GIVE US A CALL, WE MAY HAVE WHAT YOU WANT—

ORDERING INFORMATION: Call (518) 436-9606 to place orders or mail orders to Scanner World, USA®, 10 New Scotland Ave., Albany, N.Y. 12208. Orders will be shipped within 24 hours by United Parcel Service if order is accompanied by MasterCard, Visa, cashier's check, money order, COD (COD shipped by United Parcel Service will be cash only). (If a COD package is refused, customer will be billed for shipping and COD charges.) Mail orders with personal or business checks enclosed will be held 4 weeks for bank clearance. Prices, specifications, and terms subject to change without prior notice. If items are out of stock we will back order and notify you of delivery date. All shipments are F.O. B. Scanner World® warehouse in Albany, N.Y. We are not responsible for typographical errors. All merchandise carries full manufacturer's warranty. Bid proposals and purchase orders accepted from government agencies only. Free full line catalog mailed 4 times per year. Merchandise delivered in New York State add your local sales tax. No returns accepted after 7 days of merchandise receipt * Add (\$) per item and \$4.00* for all accessories ordered at same time. COD orders will be charged an additional \$5.50 per package. Full insurance is included in shipping charges. All orders are shipped by United Parcel Service to street address only. (No. P.O. Box) Shipping charges are for the 48 continental US States only. Alaska, Hawaii and all others ask for quote on shipping charge. FAX #518-465-2945.

CIRCLE 124 ON READER SERVICE CARD

212-925-7000

SHORTWAVE RECEIVERS, HAM RADIOS, BOOKS
ANTENNAS, SCANNERS, Business Radios.
MOTOROLA, ICOM, YAesu, KENWOOD, SONY
GRUNDIG, UNIDEN, ANTENNAS, ETC.
... our 45th Year ... Worldwide shipping.
Sales ... Service. Large Showroom. Open 7 days.

Barry Electronics Corp.
WORLD WIDE AMATEUR RADIO SINCE 1950
Your one source for all Radio Equipment!

1-800-990-2929

Fax 212-925-7001

540 Broadway, NYC, NY 10012

CIRCLE 55 ON READER SERVICE CARD

C. CRANE COMPANY

COMMUNICATION

Shortwave • Scanners • Antennas
SANGEAN, GRUNDIG, DRAKE, UNIDEN

The most powerful loop antennas for
Shortwave/MW and much more!

International shipping

558 - 10TH ST. FORTUNA CA 95540

Free Catalog FAX 707-725-9060

800 - 522 - (TUNE) 8863

CIRCLE 56 ON READER SERVICE CARD

CANADIANS ONLY!

FULL LINE COMMUNICATIONS CATALOG

NEW 52 PAGE 1996 CATALOG NOW AVAILABLE
LOWEST PRICES AND BEST SELECTION IN CANADA
OVER 2000 DIFFERENT ITEMS IN STOCK ONLY \$3.00

• CB RADIOS • MARINE RADIOS
• SCANNERS • AMATEUR GEAR

Durham Radio Sales & Service Inc.
350 Wentworth St. E., Oshawa, Ont. L1H 7R7
Ph: (905)436-2100 Fax: 436-3231 Web: durhamnet.com

CRYSTAL CONTROLLED SURVEILLANCE

VHF & UHF PROFESSIONAL ENCASED PARTIALLY
ASSEMBLED TRANSMITTER KITS

Countersurveillance. Also Tunable 70 to 305 MHz Kits. We
Design & Manufacture Our Equipment. Custom Design.

FOR CATALOG SEND \$2.00 TO:

SHEFFIELD ELECTRONICS CO., P.O. Box 377940-S
Chicago, IL 60637-7940, Tel. (312) 324 2196



Quality Microwave TV Systems
WIRELESS CABLE - ITFS - MMDS
ATV - INTERNATIONAL - S-BAND
Amplifiers • Antennas • Books • Components
Filters • Systems • Video Products
• RF Frequency 1990 - 2700 MHz
• Cable Ready - VHF - UHF Outputs
• SASE For 'FREE' Catalog or Send \$1

PHILLIPS-TECH ELECTRONICS

PO Box 8533 • Scottsdale, AZ 85252

ORDER LINE 800-880-MMDS

CATALOG/INFO 602-947-7700

FAX LINE 602-947-7799

CHALLENGER SYSTEM
33-Channel 52dB+ Gain
Complete Grid 5265
Five Year Warranty
FREE SHIPPING Visa • MC • Amx • Disc • COD's • Qty Pricing

CIRCLE 66 ON READER SERVICE CARD

PAN-COM INT'L CATALOG. Over 350 Kits, Plans. Licensed/unlicensed AM/FM broadcasting. Ham/CB/SW/DX, 1750M transmitters. Surveillance devices, Computers/Software, Science Projects. MORE! \$1 refundable. Box 130-P08, Paradise, CA 95967.

CW? NO PROBLEM. You can increase your speed, no matter how many times you've failed before. **Results guaranteed** when you follow the instructions. Alternative Art's CW Mental-Block Buster program helps you **explode mental blocks** that hold you back. Based on 40 years of research, the **CW Mental-Block Buster** uses guided meditation, dynamic visualizations, and powerful affirmations to blast through mental blocks. You can do code! That means new bands, more contacts, more fun! (This is not a CW practice tape.) The CW Mental-Block Buster audio cassette and practice booklet are only \$29.95 ppd. in the US. (Quantity discounts available for classes.) **Alternative Arts**, 4601 Rosemare Rd., Parkersburg, WV 26101. (304) 422-2767. MC/VISA, COD. Mail orders include signature. Office hours after 4:30 Eastern.

SCANNER MODIFICATION HANDBOOK VOL.1 by Bill Cheek. The famous original 160-page books. Performance improvement modifications. Simple step-by-step instructions, many photos. Primarily PRO-2004 & PRO-2005, some for PRO-34, BC-200/205XLT, BC-705XLT, BC-705XLT. Restore blocked-out bands, speed up scanning rate, disable "beep," increase number of channels, improve squelch action, add an S-meter, interface with shortwave receivers, etc. Make the PRO-2004 & 2005 into a 6,400 channel scanner; put 3,200 channels into the PRO-34! Plus, cellular frequency charts, antenna info & mods, inside info on frequency management, operating hints, emergency power supplies, scanners & the law, lots more! Only \$18.95. plus \$5.00 s/h (Canada \$6). Residents of NY State add \$2.36 tax. Big 220 page **VOL. 2** with more mods for PRO-2004/ 5/6. PRO-34, PRO-2022, BC-760/950XL, BC200/205XL, also available, \$18.95 plus \$5.00 s/h (Canada \$6), NY State residents include \$2.36 tax. **NEW! The Ultimate Scanner. VOL. 3.** Giant 240-page edition. Many more mods! Picks up where the first two books ended. \$29.95 plus \$5 s/h (Canada \$6), residents of NYS add \$2.97 tax. Order from CRB Research Books, Inc., PO Box 56, Commack, NY 11725. Visa/MC welcome. Tel: 1-800-656-0056.

UHF MILITARY BAND (225 to 400 MHz) monitoring aids. High performance MAX-225 ground plane antenna designed especially for this band, fully assembled, \$29.95 plus shipping. GRE Super Amplifier 20 dB scanner preamp (100 to 1000 MHz), \$55.95 plus shipping. "Directory of North American Military Aviation Communications," your state or province, \$24.95 plus shipping. "Top Secret Registry," \$21.95 plus shipping. USA shipping is \$5 for first item, and \$1 for each additional item. Canadian shipping \$6 for first item, and \$2 for each additional. NY State residents add 8.5% sales tax to item price and shipping cost. MC/VISA welcome. CRB Research, P.O. Box 6, Commack, NY 11725. Phone orders: 1-800-656-0056, Canada/AK/HI phone orders: (516) 543-9169.

CABLE DESCRAMBLER! Build with seven Radio Shack parts for under \$12! Complete instructions only \$8. F.A.S.T., Box 369-U3, Pt. Salerno, FL 34992-0369.

CW Lite is the **easiest** Morse Code training method in the world, bar none! And it is the fastest, too. Just closed your eyes and relax. This powerful **hypnosis cassette tape** does the rest. Subliminals speed you along! Only \$15.95 ppd in US Order today! **Alternative Arts**, 4601 Rosemare Rd., Parkersburg, WV 26101. (304) 422-2767. MC/VISA, COD. Mail orders include signature. Office hours after 4:30 Eastern.

PRO 23, 34, 37, 39, 43, 46, 51, 2006, 2022, 2026, 2027, 2032, BC-855XLT, BC-200, BC-2500XLT 800 MHz modifications. Well explained and illustrated steps, \$12 each, or \$20 if we do modification. Also modifications for cellular receivers BC80AT, 150, 220, 700, 860, 890, 2500, 3000, 8500, 9000, TR980, 1200, 2400, PRO2035, AR8000, \$7 each. Available to sell your products in Quebec and Canada; new brands and products welcome. A.P., 500 Dineen, Apt. 200, Labrador City, Newfoundland, A2V 1E6 Canada.

HOME AUTOMATION. Become a dealer in this fast-growing field. Free information. Send name, address, phone to ECS, Box 407, Fairbury, NE 68352, or call (800) 838-4051.

HAM RADIO PROGRAMS (plus 100s of other applications). Low as \$1.00 per disk. Send \$2.00 for catalog and sample disk to: TRI-MI SOFTWARE, 517 Pine Brook Road, Eatontown, NJ 07724. (908) 389-1049.

RADIO SHACK SCANNERS - Lowest prices all catalog items. 1000-channel PRO-2042, reg. \$499, our price, \$449. New shortwave receiver DX-394, reg. \$399., our price \$359. Call! No tax. Call 1-800-848-3004. Orders only. **COTRONICS INC.**, 2250 SE Federal Hwy., Stuart, FL 34994.

FREE IMPORT/EXPORT CB CATALOG by FAX-ON-DEMAND 24 hours a day. **LOWEST PRICES.** Call **LORD/WYATT COMMUNICATIONS**, (718) 789-7329.

LAST CHANCE: We have a very limited supply of the modifiable cellular Bearcat scanners left, BC-200XLT, BC-2500XLT, BC-890XLT, etc. Once these are gone, they are gone forever. Call for close-out prices—we ship COD, and free U.P.S. shipping to 48 states. Galaxy, Box 1202, Akron, OH 44309, (216) 376-2402, 8:30-4:30 EST. Our 11th year!

"FORBIDDEN SECRETS OF THE LEGION OF DOOM HACKERS!" Big 224-page handbook. The infamous LOD's condemned programs and amazing techniques, from the LOD's now shut down in BBS. Hacking, phreaking, and more! Hard to locate information, now in this Limited edition. For reference and informational purposes only. \$20.95, plus \$5 s/h (Canada \$6). NYS add \$2.21 tax. VISA/MC okay. CRB Research Books Inc., Commack, NY 11725. Phone orders: 1-800-656-0056.

MILITARY RADIOS: Easily made battery adapters for military radios & other electronics. Get **POWER UP!** Big new 96-page manual of instructions, diagrams. Use readily available commercial batteries in PRC-6, -8, -9, -10, -25, -28, -47, -74, -77, TRC-77, AN/PRC-9, AN/PRT-4, RT-77, URC-68, more; also mine detectors, night scopes, radiacs, field telephones, etc. Only \$14.95, plus \$5 s/h (\$6 Canada). NYS residents add \$1.53 tax. CRB Research Books, Box 56-PC, Commack, NY 11725. VISA/MC accepted. Phone (516) 543-9169.

MILITARY MONITORING GUIDE. New book covers all phases of Military Monitoring. Military Frequencies all services: U.S. Military Bases, Military Black Projects, Major Air Force Installations, Monitoring Equipment and Systems, Navy/Coast Guard, and more, \$19.95, plus \$4 Priority Mail. UNIVERSAL ELECTRONICS, 4555 Groves Road, #12, Columbus, OH 43232. (614) 866-4605.

INTERNATIONAL CLASSIFIED ADS. Buy sell or trade electronic "stuff." Biweekly publication. Free ads, send today! Trading CIRC-IT, 86 Victoria Street, South Kitchener Ontario Canada N2G 2A9. SASE for information. E-mail b.bllyeven@genie.geis.com.

SECRET CB BOOKS I-29, \$10 each. Sams books \$15 each. Modulation kits RCI 2950, HR 2510, Connex 3300, Cobra 148, Cobra 29, plus many more, \$17. Call 1-800-536-0109 for free catalog.

FOR SALE: Radio Shack TRC-465 40 channel AM/SSB mobile transceiver. Like new with antenna. (6087) 326-6421. Ask for Jeff.

CABLE DOCTOR—Stop the bullet and ID signaling cable lines. Send \$21 to RR Enterprises, Department PC, Box 3532, Easton, PA 18043.

VHF AERO SCANNER GUIDE: Kneitel's Air-Scan, sixth edition. Great new edition of the new comprehensive and popular USA/Canada VHF aero band directory ever published: Civilian, Military, Private Airports, Helicopters & Seaplane Bases. Control Towers, ARTCC, Weather, Approach/Departure, FSS, Ground Control, ATIS, Unicom, National & Air National Guard freqs., etc. Many listings for airport security, fire/rescue, airline ground services & more beyond the aero band. You ONE "must have" guide to tens of thousands of aero related monitor frequencies! Only \$18.95, plus \$5 s/h (\$6 to Canada) from CRB Research, P.O. Box 56, Commack, NY 11725. VISA/MC accepted. Phone orders 1-800-656-0056. Orders from Canada/HI/AK: (516) 543-9169. (NYS res. add \$2.04 tax.)

FOR SALE: Icom R-1, \$250. Pro-43, \$200. Yacht Boy, \$200. Call Peter, (941) 332-1424.

BUILD THE ULTIMATE 11 meter vertical. For detailed plans send \$15 to Terrapin Sales, P.O. Box 12426, La Crescenta, CA 91224-5426.

JUST PUBLISHED, Bill Cheek's The Ultimate Scanner (Cheek 3) doesn't just build on his two earlier bestsellers. His new, indispensable bench manual goes further and faster, detailing scanner modification technology including memory enhancements, up to 25,600 channels, cellular restoration, simple ways automate arduous scanning tasks, signal discrimination, computer interfaces, optimum antennas, autologging "hits," power options, SCA decoders, autorejecting, hacking, and tons more. With a wealth of step-by-step procedures, photos, charts, diagrams, and schematics, Cheek shows us how to dramatically improve scanner performance. 250 pages, large format, \$29.95 (plus \$4 s/h; CA add 7.75% tax). Index Publishing Group, Inc., 3368 Governor Drive, Suite 273P, San Diego, CA 92122; order line, (800) 546-6707.

SHORTWAVE LISTENER looking for RTTY, FAX, etc., enthusiasts in Miami, FL area. I have equipment, but can use more know-how. Maybe start a club? Call Dan, (305) 226-3987.

CRIMEFIGHTERS send \$2 for fully illustrated police equipment catalog, BPEC Department PCM795, P.O. Box 7240, Moreno, CA 92552.

CB RADIO HACKER'S GUIDE! Big 151 page book; pictorials, diagrams, text. Complete guide to peaking, tweaking, & modifying 200+ CB radios for enhanced performance & more features. Which screws to turn, which wires to cut, AM & SSB radios: Cobra, Courier, GE, Midland, Radio Shack Realistic, SBE, Sears, Uniden/President. Get the most from your CB radio & operations. Only \$19.95, plus \$5.00 shipping (\$6.00 to Canada). NY State residents add \$2.12 tax. Order from CRB Research Books, Inc., PO Box 56, Commack, NY 11725. Visa/MC OK. Tel: (516) 543-9169.

QUANTUM LOOPS. Very high performance ferrite loops (LW, MW, SW models) from \$159. Stamp for catalog. Radio Plus+ Electronics, 3635 Chastain Way, Pensacola, FL 32504; (904) 432-8208.

AM RADIO CLUB. For bulletin sample and membership info write International Radio Club of America, Box 1831, Perris, CA 92572.

LOOKING for owner's manual for Panasonic model RF-4900. Scott Douglas, 513 North Franklin Street, Juneau, AK 99801.

RECONDITIONED VHF and UHF pages with charger/amplifier. Can be set up for Monitor Only (\$89.) or Tone Alert (\$195.). Excellent for use with fire, ESDA and SKYWARN nets. One year warranty. FRYCOMM, Ltd. (708) 422-0922.

FOR SALE: ICOM R-1 full coverage, complete with BP-90. Excellent condition., \$350. Jim, (810) 634-8099.

SOFTWARE. Communications electronics study program. General radiotelephone, CET preparation. 84 modules, on four 3.5-inch diskettes. Requires EGA/CGA. Interactive and user friendly. \$35 for entire program. Tutor-tech, 170 Locksunart Way #2, Sunnyvale, CA 94087, (408) 481-9543.

RADIO MONITORS NEWSLETTER OF MARYLAND FOR THE SERIOUS SHORTWAVE AND SCANNER LISTENERS. PO BOX 394, Hampstead, MD 21704. For a one year subscription: \$15.00. Sample copy: one dollar.

WOW! UNDERSTANDING & REPAIRING CB RADIOS by Lou Franklin. Giant 380-page technical book picks up where THE "SCREWDRIVER EXPERTS" GUIDE leaves off. Includes circuit descriptions and troubleshooting guide for virtually all CB radios: 23 and 40-channel, crystal and PLL, solid-state and tube, AM, FM, SSB, CW, American, British and export models. Covers test equipment, transistor basics, synthesizers, receivers, transmitters, power supplies, T/R switching, antennas, interference, parts and accessory sources. Over 350 illustrations, plus huge subject index. Moneyback Guarantee! Only \$29.95, plus \$3.50 U.S & Canadian Air Mail, VISA/MC accepted. Free catalog of unique CB books, plans, and modification kits with order. Catalog only \$3. CBC INTERNATIONAL INC., BOX 31500PC, Phoenix, AZ 85046. Thousands of satisfied customers since 1976.

SAVE 75% SONY CRF-V21



**EEB Scoops the Market!
Originally \$3995...
NOW \$995... That's right
\$3000 off Sony price
100% NEW in sealed Sony
factory box, full Sony
Factory 1 year warranty**

- World band radio covers all shortwave bands AM, FM, and VHF satellites band
- Weather FAX printer built-in, - Drum speed 60-90-120-240rpm
- All mode: AM, FM, FMW, SSB, FAX
- Spectrum display and print out
- Decodes & prints radio teletype - RTTY baudot 60-66-75-100wpm - ASCII 110, 200, 300, 600bps
- 350 memory freq, mode, name, notes
- Active FM & SWL ant. included
- Wide & Narrow filter selection
- Synchro detection, sideband selectable
- Scanning tunes in 10Hz steps
- Tunes:
 - 9kHz - 30MHz AM, SSB, FAX
 - 76 - 108MHz FM Music
 - 137.6 - 141MHz WX Satellite
- Selectivity: 2.7, 3.5, 6, 14kHz
- 110/120/220/240VAC, 6VDC NiCad incl.

Size: 16 x 11 x 7, Wt: 21lbs. w/ batt

Ideal for the mariner that needs to stay in touch with world news & weather, serious listeners and hobbyist. This is a one time deal with limited quantity. Order now...don't be disappointed. They are going fast!

See our full page ad this issue for more spring housecleaning deals...
EEB will beat any advertized deal

orders: 800 368 3270

**Electronic Equipment Bank
323 Mill Street
Vienna, VA. 22182
Ph: (703) 938 3350
FAX: (703) 938 6911**



CABLE TV DESCRAMBLERS/CONVERTERS. Why rent? Lower your bill. SAVE \$. Wholesale prices. Money back guarantee. Free 30-day trial. **RP ELECTRONICS**, 1-800-304-3604.

FM BROADCASTING: Transmit many miles, stereo/mono 88-108 MHz. R.F. amps. Kit or assembled, full info, call 24 hours. R. Scott Communications, (604) 642-2859.

R390A SALES & SERVICE. Info SASE Miltronix POB 80041, Toledo, OH 43608. R-390 Power input cables, \$25. Antenna connectors, \$12.50. External AGC mod, \$20. p.p.d. Mon-Fri, 9 a.m.-6 p.m., EST. (419) 255-6220.

SCANNING RECEIVERS for monitoring police, fire, aircraft. Base, mobile, handheld. Antennas, CBs and accessories. HPR, Box 621136C, Littleton, CO 80162.

RESTRICTED Top Secret Hacker Information. Cellular/Cable/Surveillance/Satellite/VideoCipher/Books/Videos—Software. Make \$100/hour! Catalog—\$3. **TELECODE**, P.O. Box 6426-PC, Yuma, AZ 85366-6426.

GREAT READING for the winter SWL season—wonderful; (and inexpensive!) back issues of "Popular Communications"—the first 8 1/2 years (over 100 issues), all excellent in binders—\$199 takes all! Ted Osborn, Box 71, Ithaca, NY 14851; (607) 273-5323.

BUY/SELL—Older ham & military shortwave receivers & transmitters. List—SASE. The Radio Finder, 11803 Priscilla, Plymouth, MI 48170. Tel/fax: (313) 454-1890.

PIRATE RADIO, TIS or emergency AM/MW/LW antennas. CB 10/40 or 80m verticals. HF discone. Send SASE to HELIXING, 1302 McCameron, Lockport, IL 60441.

WANTED: "World Radio Handbook" circa 1955 or earlier. Also pre-1970 lists of U.S. radio stations such as White Radio Log (including photocopies). Ralph Marson, 8070 Busch, Centerline, MI 48015.

ILLINOIS SCANNER BUFFS. Subscribe to Scanning Illinois, monthly newsletter for Illinois. 2-3 pages of frequencies, public safety news, and more. \$12, 12 issues or send \$3 and SASE for sample. Send to Alex Blaha, 2054 Hawthorne, Joliet, IL 60435.

800 MHz & CORDLESS PHONE high performance antenna plans. Send \$5 and SASE to SCOTT, 1012 N. Elm, McPherson, KS 67460.

HAMFEST. HAMCOMP '96 sponsored by the Delaware Valley Radio Association on March 24, in Trenton, NJ. Write HAMCOMP, P.O. Box 7024, W. Trenton, NJ 08628, or call (609) 882-2240.

RAMSEY KITS, 15% OFF! Call or write for list or to order. (610) 273-7823, 9 a.m.-9 p.m. DX Radio Supply, Box 360, Wagontown, PA 19376. Since 1982.

PHILLIPS DC777 Auto Stereo Wanted. Write or call Michael Simone, 273 Rockport Road, Port Murray, NJ 07865, (908) 813-1150. State price and condition.

RADIO BUYERS CLUB—Lowest prices, brand names, Cobra, Uniden and more, more, more. Send name, address and phone or call for application. SS Elect., 757 Highway 98 E., #14-189, Destin, FL 32541, 800-888-4117.

PRO-2006 NEW IN BOX, \$435. PRO-2022, 200-channel, full 800-MHz, \$240. Bearcat 855, 100-channel, full 800-MHz, \$150. PRO-2004, new backlight panels, \$42.50. Call (303)840-0727, please leave message.

Advertisers' Index

A.M.C. Sales, Inc.	51
A.R.R.L.	39
AOR, LTD.	Cov II
Ace Communications.	Cov III
Alpha Delta Communications, Inc.	27
Antique Radio Classified.	84
Atlantic Ham Radio.	33
BCB.	65
Barry Electronics Corp.	86
C. Crane Company.	86
CB Radio Buyer's Guide.	77
CB Radio Magazine.	72
CQ Books & Videos.	82,83
CQ VHF Magazine.	16
CRB Research.	48,65,66
Cellular Security Group.	28
Communications Electronics, Inc.	21
Computer Aided Technologies.	29
DECO Industries.	57
Delta Research.	71
Drake, R.L. Company.	13
Durham Radio Sales & Service, Inc.	86
EDCO.	7,9,69
Electronic Equipment Bank.	1,87
Firestik Antennas & Accessories.	65
G & G Electronics.	37
Genie Radio & Elec. RoundTable.	84
GMRS Radio Sales.	6
Index Publishing Group, Inc.	76
Intensitronics Corp.	53
Japan Radio Co., Ltd.	73
Jesse Jones Industries.	88
Jo Gunn Enterprises.	40
K & L Technology.	71
Lentini Communications, Inc.	23
MFJ Enterprises, Inc.	43
Microcraft Corporation.	37
MoTron Electronics.	27
Optoelectronics, Inc.	4, Cov. IV
Phillips-Tech Electronics.	86
Popular Communications Guide.	66
R.C. Distributing.	77
REACT International.	33
Radio Bookstore.	84
Radioware Corporation.	65
Scanner World USA.	85
Scrambling News.	37
Sheffield Electronics Co.	86
Sherwood Engineering Inc.	77
Signal Engineering.	6
Signal Intelligence.	51
Software Systems Consulting.	23
Spectrum International, Inc.	17
Timestep.	17
Tucker Electronics.	15
U.S. Scanner Publications.	48
USRadio.	57
Universal Radio, Inc.	3
Viking International.	53
Wilson Antenna, Inc.	11
Xandi Electronics, Inc.	40
Yaesu U.S.A.	75

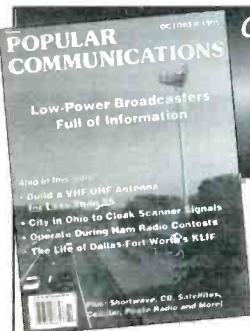

ORGANIZE AND PROTECT YOUR COPIES OF

POPULAR COMMUNICATIONS

Now there's an easy way to organize and keep copies of your favorite magazine readily available for future reference.

Designed exclusively for **PC** by Jesse Jones Industries, these custom made titled cases and binders provide the luxury look that makes them attractive additions to your bookshelf, desk or any location in your home or office.

Each binder/case is coverflat blue with durable leather-like material in flat blue; title is hot-stamped in gold.

Whether you choose cases or binders, you'll have a storage system that's durable and well organized to help protect your valuable copies from damage.

When ordering binders please include the following information. Name, Address (no P.O. Box numbers), City, State, Zip. Amount ordered (binders or cases). Method of payment.

Mastercard, Visa, Diners Club, American Express accepted (minimum \$15). Include credit card number, expiration date and signature.

Quantity	Cases	Binders
One	\$ 8.95	\$11.25
Three	\$24.95	\$31.85
Six	\$45.95	\$60.75

Add \$1.50 per case/binder for postage and handling. Outside USA \$3.50 per case/binder. (U.S. funds only)
Allow 4 to 6 weeks for delivery
PA Residents add 7% sales tax

POPULAR COMMUNICATIONS

Jesse Jones Industries, Dept. 95 P-Comm
499 East Erie Avenue, Philadelphia, PA 19134

Call TOLL FREE 7 days, 24 hours 1-800-825-6690

Reach this dynamic audience with your advertising message, contact Don Allen, N9ALK at 217-344-8653, FAX 217-344-8656



Grundig
YB400
\$199



Sangean
ATS818
\$145



Bearcat BC990XL
29-958MHz
\$249



Bearcat
BC3000
25-
1300MHz
\$379



Bearcat
BC220
Turbo
\$229



Bearcat BC3000XL
25-1300MHz \$379



Police Fire Action
Videos \$24.95



Trident
TR980
5-999MHz
AM/NFM &
WFM
\$299



Trident
TR1200
.5-1300MHz
AM/NFM/WFM
1000 Channels
\$399



Trident
TR2400
100KHz-
2060MHz
1KHz steps
VFO,
BFO/USB,LSB,
Signal Strength
Meter
\$499



Trident Spectrum Analyzer with demod
1-1300MHz up to 500MHz span \$699

Tech Support 317-845-7436

1 800 445 7717

Faxback Service 317-849-8683

Fax 317-849-8794

10707 East 106th Street Fishers, IN 46038

E Mail: ACESCAN@aol.com

Computer BBS 317-579-2045

CIRCLE 15 ON READER SERVICE CARD

Call about these and a host of other radio receivers and accessories from anywhere in the world, 24 hours a day, 7 days a week. For computer users, our BBS offers free product and frequency information, or use our faxback service for instant specs and info. So call us now, we'll give you the benefit of our over 20 years experience with radio receivers. Mastercard, Visa, AMEX, Discover, Government & Corporate P.O's. plus COD. Price/specs/availability subject to change. Free trial period on all units. All units carry full factory warranty. IN residents add Tax. Flat rate ground shipping, \$6.95. Air Freight for as little as \$10.95 per unit for most locations. All trademarks property of their respective owners. Products are made or licensed under a variety of patents, write for details. Call to confirm price and delivery before ordering.



YOU *NEVER* KNOW WHEN A FREQUENCY IS GOING TO TRANSMIT...

Relax. There's no need to get uptight about missing that important frequency. With Scout Reaction Tune, capturing frequencies is like a day at the beach. Pure bliss! Interface the Scout to the AOR AR8000 and the Scout will not only show you which frequency is being transmitted, but you'll be able to instantly hear the conversation from the AR8000 as well. The Scout can record 400 frequencies into memory, with up to 255 hits per frequency (From 10MHz - 1.4GHz). The Scout distinctively beeps indicating frequency hits, or switch to a pager style vibrator for discreet recording. Built-in rapid charge NiCads provide a full ten hour discharge time.

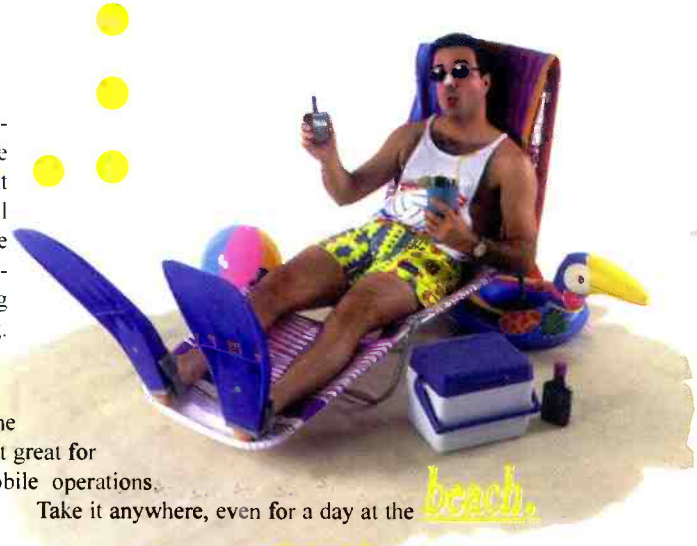

Take it anywhere, even for a day at the beach.

BUT WITH SCOUT REACTION TUNE...™

Portability, functionality and the hand-held size of the Scout make it great for mobile operations.

Specifications

- 16 segment RF signal strength bargraph.
- 10 digit LCD display w/ EL backlighting.
- Reaction Tune™ the AOR AR8000/2700, ICOM R7000 R7100, and R9000 and Realistic Pro 2005/6 w/OS456 Pro 2035 w/OS535 Scanners not sold by Optoelectronics.
- Download frequencies into PC using optional CX12AR.
- Beeper / Vibrator to indicate frequency capture.
- Full on screen function annunciators.
- Memory Tune - Scroll through Scout memory to tune receiver.

Scout..... \$449.00

YOU'RE DEFINITELY GONNA CATCH IT.

Computer control For Your AR8000

The only universal converter with both CI-V and full duplex modes, a dedicated squelch status input, and dedicated software controlled tape output relay. Use for hassle free computer control of the AOR AR8000, as well as the ICOM R7000, R7100, and the R9000. Downloads Scout data to a PC. Includes all cables, adaptors, and demo software. (Supported by ScanCat, ScanStar and ScannerWear for Windows)

\$99.

CX12AR



Scout shown with AOR AR8000, Scanner not included
Minor modification to the AR8000 required
Scanners not sold by Optoelectronics

OPTOELECTRONICS®

5821 NE 14th Avenue • Ft. Lauderdale, FL 33334
Visa, MasterCard, C.O.D. (Cash or Money Order)

Prices and Specifications are subject to change without notice.

MADE IN THE USA

ORDER LINE • 800-327-5912

Tel: 305-771-2050

Fax: 305-771-2052

CIRCLE 150 ON READER SERVICE CARD